

PQxxxY3H3Z Series/ PQxxxY053Z Series

■ Features

1. Low power-loss
(Dropout voltage:MAX.0.5V)
2. Compact surface mount type package
(Size:10.6×13.7×3.5mm)
3. High output current type
4. Low voltage operation (Minimum supply voltage:2.35V)
5. High-precision output type
(Output voltage precision:±1%)
6. Overcurrent, overheat protection functions

■ Applications

1. PC motherboard, PC peripherals
2. Power supplies for various electronic equipment such as AV, OA

■ Model Line-up

Output current (I _O)	Package type	Output voltage (V _O)		
		1.5V	2.5V	3.3V
3.5A	Taping	PQ015Y3H3ZP	PQ025Y3H3ZP	PQ033Y3H3ZP
	Sleeve	PQ015Y3H3ZZ	PQ025Y3H3ZZ	PQ033Y3H3ZZ
5A	Taping	PQ015Y053ZP	PQ025Y053ZP	PQ033Y053ZP
	Sleeve	PQ015Y053ZZ	PQ025Y053ZZ	PQ033Y053ZZ

■ Absolute Maximum Ratings (T_a=25°C)

Parameter	Symbol	Rating	Unit
Input voltage	V _{IN}	7	V
Extremes of input-output voltage	V _{I-O}	4	V
*1 Output control voltage	V _C	7	V
Output current	I _O	3.5	A
		5	
*2 Power dissipation	P _D	35	W
*3 Junction temperature	T _j	150	°C
Operating temperature	T _{opr}	-20 to +80	°C
Storage temperature	T _{stg}	-40 to +150	°C
Soldering temperature	T _{sol}	260 (10s)	°C

*1 All are open except GND and applicable terminals

*2 P_D:With infinite heat sink

*3 Overheat protection may operate at the condition T_j=125°C to 150°C

High Output Current, Compact Surface Mount Type Low Power-Loss Voltage Regulator

■ Outline Dimensions

(Unit : mm)

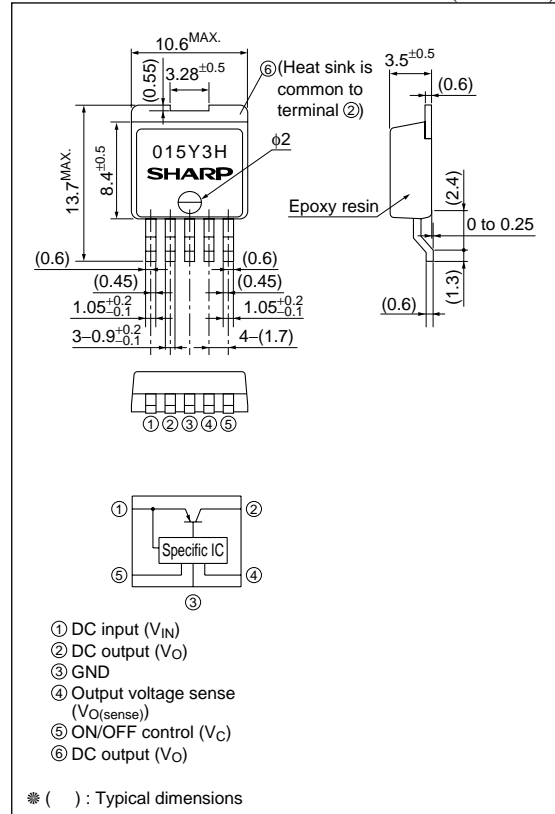

■ Electrical Characteristics (PQ015Y3H3Z/PQ015Y053Z)

(Unless otherwise specified, condition shall be $V_{IN}=5V$, $I_O=1.75A$ (PQ015Y3H3Z), $I_O=2.5A$ (PQ015Y053Z), connects $V_{O(SENSE)}$ terminal to V_O terminal, $T_a=25^\circ C$)

Parameter	Symbol	Conditions	MIN.	TYP.	MAX.	Unit	
Input voltage	V_{IN}	–	2.35	–	7	V	
*4 Output voltage	V_O	Connects $V_{O(SENSE)}$ terminal to V_O terminal	1.485	1.5	1.515	V	
Load regulation	PQ015Y3H3Z PQ015Y053Z	R_{regL}	$I_O=5mA$ to 3.5A	–	0.1	0.5	%
			$I_O=5mA$ to 5A				
Line regulation	R_{regI}	$V_{IN}=2.5$ to 5.5V, $I_O=5mA$	–	0.05	0.1	%	
Output voltage temperature coefficient	TcV_O	$T_j=0$ to $125^\circ C$, $I_O=5mA$	–	± 1	–	%	
Ripple Rejection	RR	Refer to Fig.2	60	70	–	dB	
*5 Output on control voltage	$V_{C(ON)}$	–	2.0	–	–	V	
Output on control current	$I_{C(ON)}$	$V_C=2.7V$	–	–	20	μA	
Output off control voltage	$V_{C(OFF)}$	–	–	–	0.8	V	
Output off control current	$I_{C(OFF)}$	$V_C=0.4V$	–	–	–0.4	mA	
Quiescent current	I_q	$I_O=0A$	–	5	10	mA	

■ Electrical Characteristics (PQ025Y3H3Z/PQ025Y053Z)

(Unless otherwise specified, condition shall be $V_{IN}=5V$, $I_O=1.75A$ (PQ025Y3H3Z), $I_O=2.5A$ (PQ025Y053Z), connects $V_{O(SENSE)}$ terminal to V_O terminal, $T_a=25^\circ C$)

Parameter	Symbol	Conditions	MIN.	TYP.	MAX.	Unit	
*4 Output voltage	V_O	Connects $V_{O(SENSE)}$ terminal to V_O terminal	2.475	2.5	2.525	V	
Load regulation	PQ025Y3H3Z PQ025Y053Z	R_{regL}	$I_O=5mA$ to 3.5A	–	0.1	0.5	%
			$I_O=5mA$ to 5A				
Line regulation	R_{regI}	$V_{IN}=3$ to 6.5V, $I_O=5mA$	–	0.05	0.1	%	
Output voltage temperature coefficient	TcV_O	$T_j=0$ to $125^\circ C$, $I_O=5mA$	–	± 1	–	%	
Ripple Rejection	RR	Refer to Fig.2	60	70	–	dB	
Dropout voltage	PQ025Y3H3Z PQ025Y053Z	V_{I-O}	*6 $I_O=3.5A$	–	–	0.5	V
			*6 $I_O=5A$				
*5 Output on control voltage	$V_{C(ON)}$	–	2.0	–	–	V	
Output on control current	$I_{C(ON)}$	$V_C=2.7V$	–	–	20	μA	
Output off control voltage	$V_{C(OFF)}$	–	–	–	0.8	V	
Output off control current	$I_{C(OFF)}$	$V_C=0.4V$	–	–	–0.4	mA	
Quiescent current	I_q	$I_O=0A$	–	5	10	mA	

■ Electrical Characteristics (PQ033Y3H3Z/PQ033Y053Z)

(Unless otherwise specified, condition shall be $V_{IN}=V_O(TYP)+1$, $I_O=1.75A$ (PQ033Y3H3Z), $I_O=2.5A$ (PQ033Y053Z), connects $V_{O(SENSE)}$ terminal to V_O terminal, $T_a=25^\circ C$)

Parameter	Symbol	Conditions	MIN.	TYP.	MAX.	Unit	
*4 Output voltage	V_O	Connects $V_{O(SENSE)}$ terminal to V_O terminal	3.267	3.3	3.333	V	
Load regulation	PQ033Y3H3Z PQ033Y053Z	R_{regL}	$I_O=5mA$ to 3.5A	–	0.1	0.5	%
			$I_O=5mA$ to 5A				
Line regulation	R_{regI}	$V_{IN}=4$ to 7V, $I_O=5mA$	–	0.05	0.1	%	
Output voltage temperature coefficient	TcV_O	$T_j=0$ to $125^\circ C$, $I_O=5mA$	–	± 1	–	%	
Ripple Rejection	RR	Refer to Fig2	60	70	–	dB	
Dropout voltage	PQ033Y3H3Z PQ033Y053Z	V_{I-O}	*6 $I_O=3.5A$	–	–	0.5	V
			*6 $I_O=5A$				
*5 Output on control voltage	$V_{C(ON)}$	–	2.0	–	–	V	
Output on control current	$I_{C(ON)}$	$V_C=2.7V$	–	–	20	μA	
Output off control voltage	$V_{C(OFF)}$	–	–	–	0.8	V	
Output off control current	$I_{C(OFF)}$	$V_C=0.4V$	–	–	–0.4	mA	
Quiescent current	I_q	$I_O=0A$	–	5	10	mA	

*4 Connects $V_{O(SENSE)}$ terminal ④ to V_O terminal ②

*5 In case of opening control terminal ⑤, output voltage turns ON

*6 Input voltage shall be the value when output voltage is 95% in comparison with the initial value

Fig.1 Standard Test Circuit

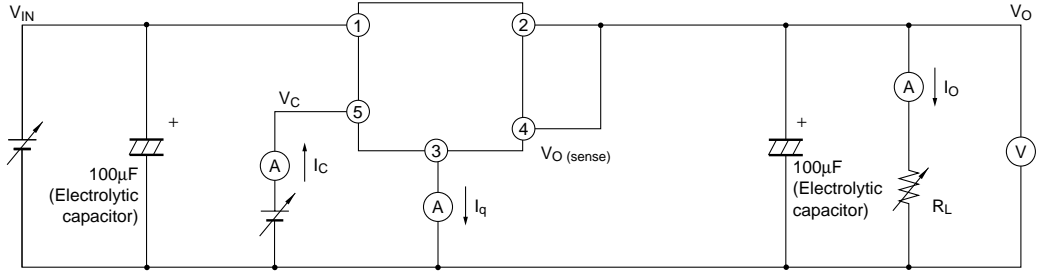
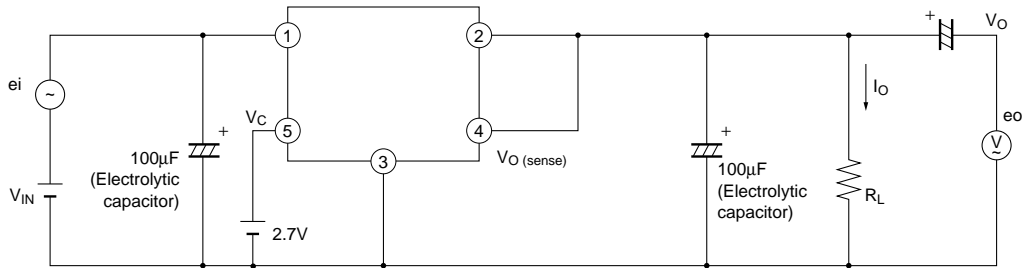
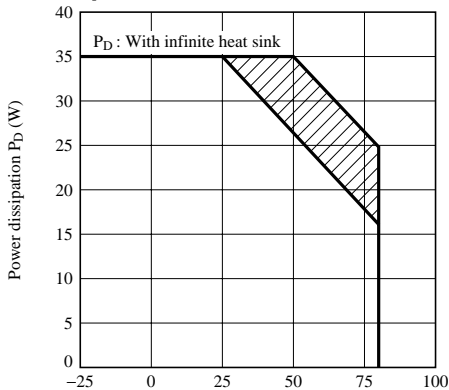

Fig.2 Test Circuit for Ripple Rejection



$f=120\text{Hz}$ (sine wave)
 $e_i(\text{rms})=0.5\text{V}$
 $V_{IN}=3.3\text{V}$ (PQ015Y3H3ZZ/P)
 $=3.3\text{V}$ (PQ025Y3H3ZZ/P)
 $=5\text{V}$ (PQ033Y3H3ZZ/P)
 $I_o=0.5\text{A}$
 $RR=20\log(e_i(\text{rms})/e_o(\text{rms}))$

Fig.3 Power Dissipation vs. Ambient Temperature



Note) Oblique line prtion:Overheat protection may operate in this area

Fig.4 Overcurrent Protection Characteristics (PQ015Y3H3Z/PQ025Y3H3Z/PQ033Y3H3Z)

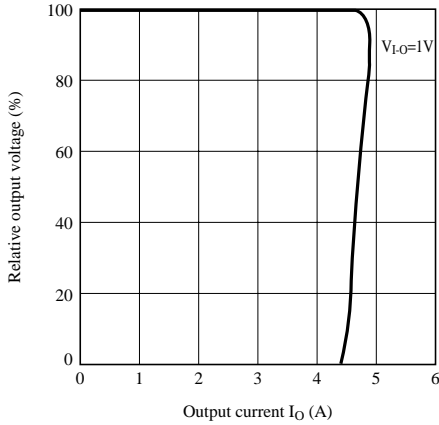

Fig.5 Overcurrent Protection Characteristics (PQ015Y053Z/PQ025Y053Z/PQ033Y053Z)

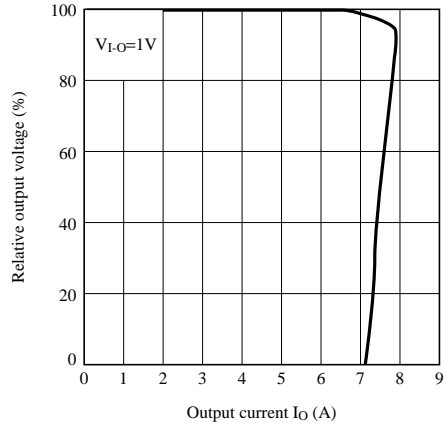

Fig.6 Output Voltage Transition vs. Ambient Temperature

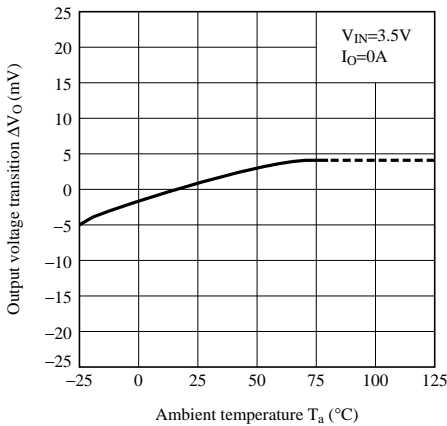

Fig.7 Output Voltage vs. Input Voltage (PQ015Y3H3Z)

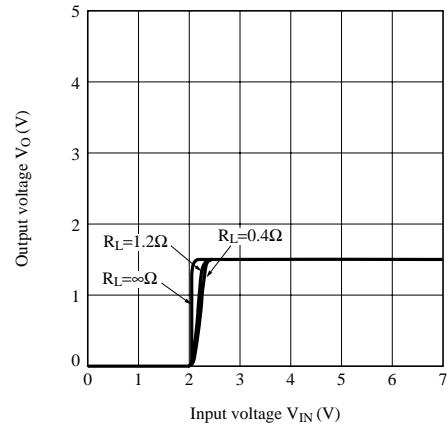

Fig.8 Output Voltage vs. Input Voltage (PQ015Y053Z)

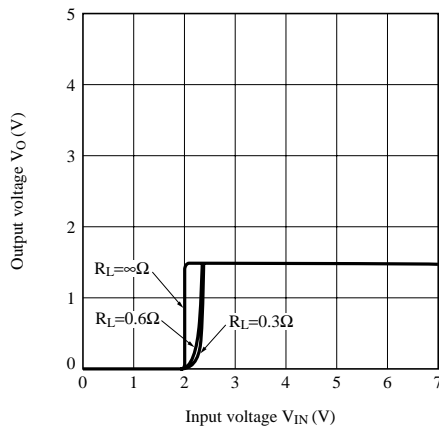

Fig.9 Output Voltage vs. Input Voltage (PQ025Y3H3Z)

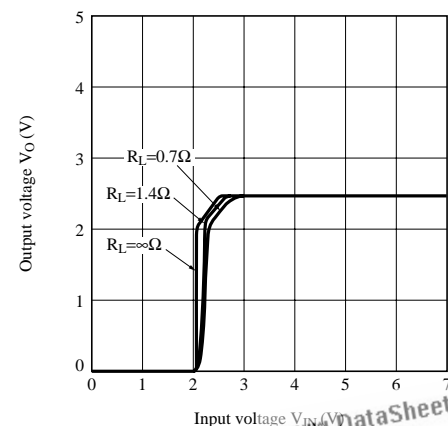

Fig.10 Output Voltage vs. Input Voltage (PQ025Y053Z)

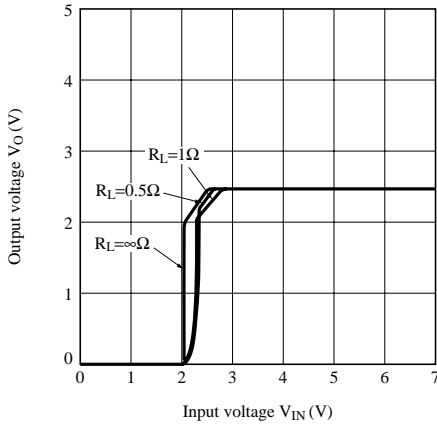

Fig.11 Output Voltage vs. Input Voltage (PQ033Y3H3Z)

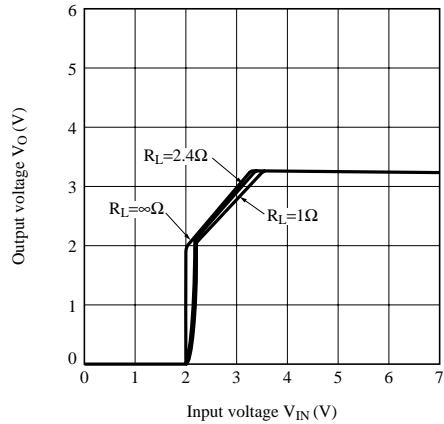

Fig.12 Circuit Operating Current vs. Input Voltage (PQ015Y3H3Z)

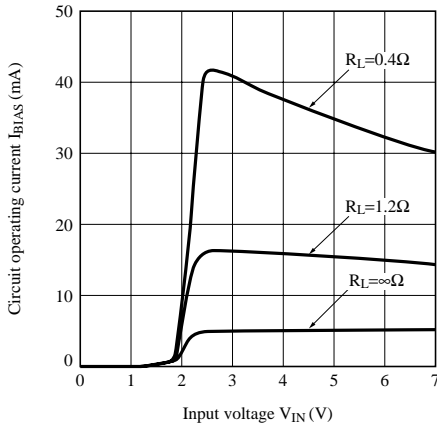

Fig.13 Circuit Operating Current vs. Input Voltage (PQ015Y053Z)

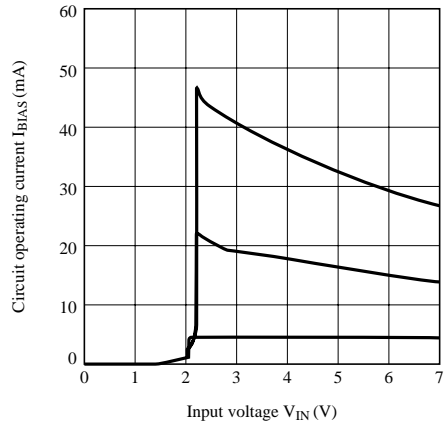

Fig.14 Circuit Operating Current vs. Input Voltage (PQ025Y3H3Z)

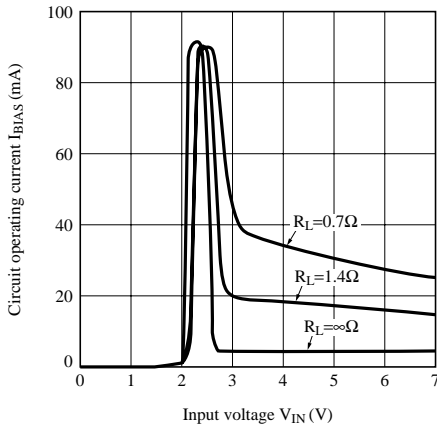

Fig.15 Circuit Operating Current vs. Input Voltage (PQ025Y053Z)

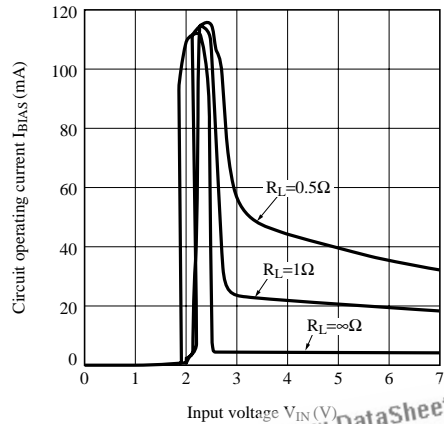

Fig.16 Circuit Operating Current vs. Input Voltage (PQ033Y3H3Z)

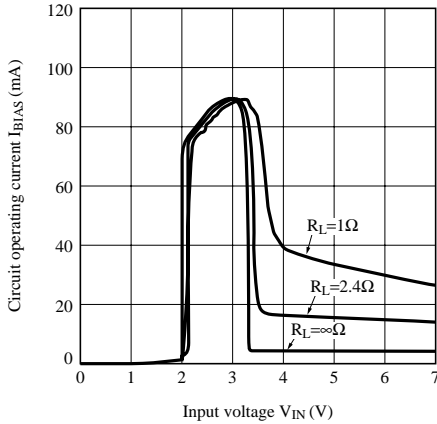

Fig.17 Ripple Rejection vs. Input Frequency (PQ025Y3H3Z)

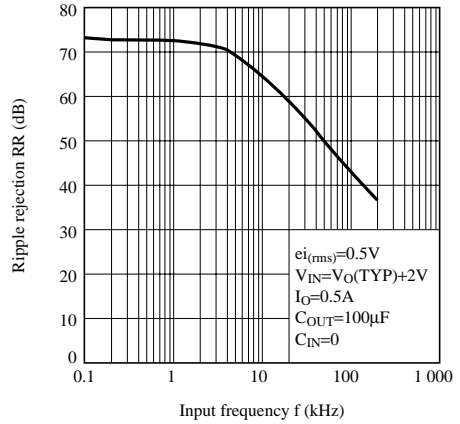
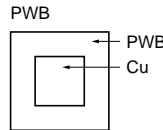
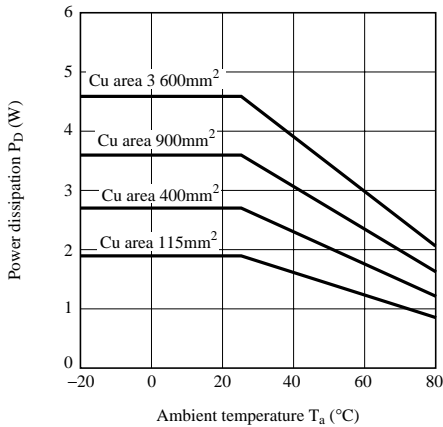
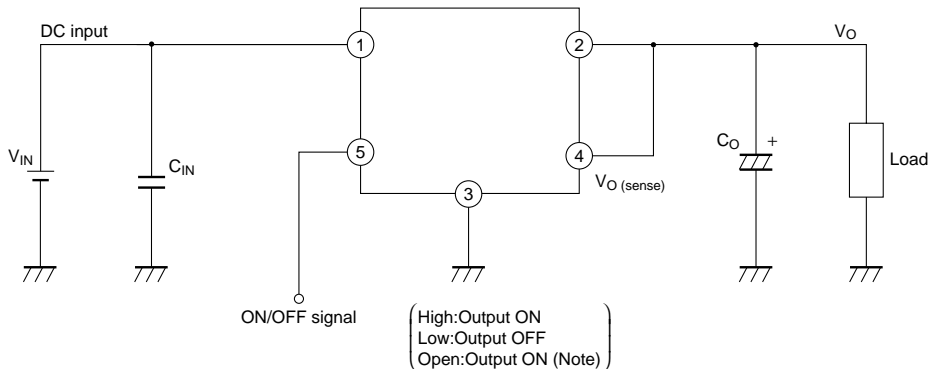

Fig.18 Power Dissipation vs. Ambient Temperature (Typical Value)



Material : Glass-cloth epoxy resin
 Size : 60×60×1.6mm
 Cu thickness : 65μm

Fig.19 Example of Application



※ Please make sure to use this device, pulling up to the power supply with less than 7V at the resistor less than 50kΩ in switching ON/OFF with open collector output or in not using ON/OFF function (in keeping "ON"), because input impedance is high in ON/OFF terminals.

■ Precautions for Use

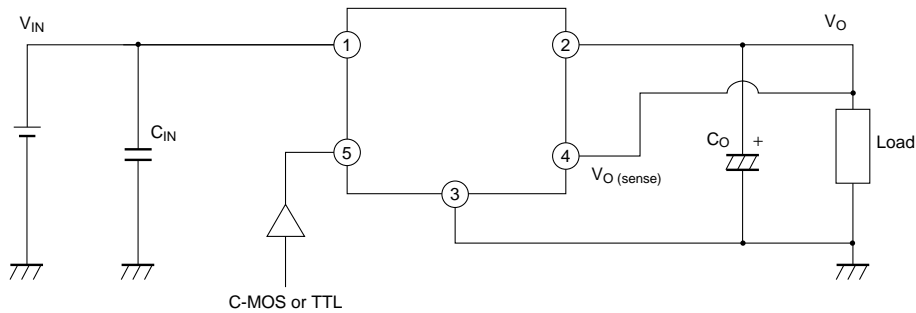

1. External connection

- (1) The connecting wiring of C_O and each terminal must be as short as possible. Owing to type, value and wiring condition of capacitor, it may oscillate. Confirm the output waveform under the actual condition before using.
- (2) ON/OFF control terminal ⑤ is compatible with LS-TTL. It enables to be directly drive by TTL or C-MOS standard logic (RCA4000 series). Please make sure to use this device, pulling up to the power supply with less than 7V at the resistor less than 50k Ω in switching ON/OFF with open collector output or in not using ON/OFF function (in keeping "ON"), because input impedance is high in ON/OFF terminals.
- (3) If voltage is applied under the conditions that the device pin is connected divergently or reversely, the deterioration of characteristics or damage may occur. Never allow improper mounting.
- (4) If voltage exceeding the voltage of DC input terminal ① is applied to the output terminal ②, the element may be damaged. Especially when the DC input terminal ① is short-circuited to the GND in ordinary operating state, charges accumulated in the output capacitor C_O flow to the input side, causing damage to the element. In this case, connect the ordinary silicon diode as shown in the figure.

2. Thermal protection design

Maximum power dissipation of devices is obtained by the following equation.

$$P_D = I_O \times (V_{IN} - V_O) + V_{IN} \times I_i$$

When ambient temperature T_a and power dissipation P_D (MAX.) during operation are determined, operate element within the safety operation area specified by the derating curve. Insufficient radiation gives an unfavorable influence to the normal operation and reliability of the device.

In the external area of the safety operation area shown by the derating curve, the overheat protection circuit may operate to shut-down output. However please avoid keeping such condition for a long time.

3. ESD (Electrostatic Sensitivity Discharge)

Be careful not to apply electrostatic discharge to the device since this device employs a bipolar IC and may be damaged by electro static discharge. Followings are some methods against excessive voltage caused by electro static discharge.

- (1) Human body must be grounded to discharge the electro charge which is charged in the body or cloth.
- (2) Anything that is in contact with the device such as workbench, inserter, or measuring instrument must be grounded.
- (3) Use a soldering dip basin with a minimum leak current (isolation resistance 10M Ω or more) from the AC power supply line.

Also the soldering dip basin must be grounded.

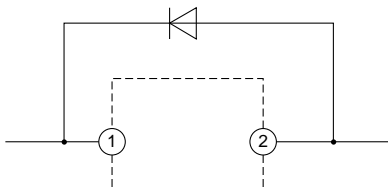

NOTICE

- The circuit application examples in this publication are provided to explain representative applications of SHARP devices and are not intended to guarantee any circuit design or license any intellectual property rights. SHARP takes no responsibility for any problems related to any intellectual property right of a third party resulting from the use of SHARP's devices.
- Contact SHARP in order to obtain the latest device specification sheets before using any SHARP device. SHARP reserves the right to make changes in the specifications, characteristics, data, materials, structure, and other contents described herein at any time without notice in order to improve design or reliability. Manufacturing locations are also subject to change without notice.
- Observe the following points when using any devices in this publication. SHARP takes no responsibility for damage caused by improper use of the devices which does not meet the conditions and absolute maximum ratings to be used specified in the relevant specification sheet nor meet the following conditions:
 - (i) The devices in this publication are designed for use in general electronic equipment designs such as:
 - Personal computers
 - Office automation equipment
 - Telecommunication equipment [terminal]
 - Test and measurement equipment
 - Industrial control
 - Audio visual equipment
 - Consumer electronics
 - (ii) Measures such as fail-safe function and redundant design should be taken to ensure reliability and safety when SHARP devices are used for or in connection with equipment that requires higher reliability such as:
 - Transportation control and safety equipment (i.e., aircraft, trains, automobiles, etc.)
 - Traffic signals
 - Gas leakage sensor breakers
 - Alarm equipment
 - Various safety devices, etc.
 - (iii) SHARP devices shall not be used for or in connection with equipment that requires an extremely high level of reliability and safety such as:
 - Space applications
 - Telecommunication equipment [trunk lines]
 - Nuclear power control equipment
 - Medical and other life support equipment (e.g., scuba).
- Contact a SHARP representative in advance when intending to use SHARP devices for any "specific" applications other than those recommended by SHARP or when it is unclear which category mentioned above controls the intended use.
- If the SHARP devices listed in this publication fall within the scope of strategic products described in the Foreign Exchange and Foreign Trade Control Law of Japan, it is necessary to obtain approval to export such SHARP devices.
- This publication is the proprietary product of SHARP and is copyrighted, with all rights reserved. Under the copyright laws, no part of this publication may be reproduced or transmitted in any form or by any means, electronic or mechanical, for any purpose, in whole or in part, without the express written permission of SHARP. Express written permission is also required before any use of this publication may be made by a third party.
- Contact and consult with a SHARP representative if there are any questions about the contents of this publication.