

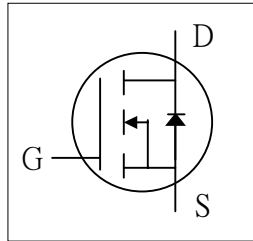

- ▼ Dynamic dv/dt Rating
- ▼ Repetitive Avalanche Rated
- ▼ Fast Switching
- ▼ Simple Drive Requirement
- ▼ RoHS Compliant



$BV_{DSS}$	700V
$R_{DS(ON)}$	2.4 $\Omega$
$I_D$	4A

## Description

AP04N70 series are specially designed as main switching devices for universal 90~265VAC off-line AC/DC converter applications. TO-220FM type provide high blocking voltage to overcome voltage surge and sag in the toughest power system with the best combination of fast switching, ruggedized design and cost-effectiveness.

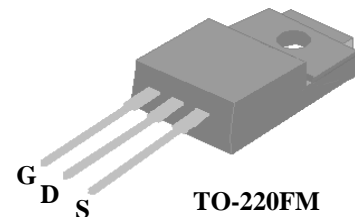

The TO-220FM package is universally preferred for all commercial-industrial applications. The device is suited for switch mode power supplies, DC-AC converters and high current high speed switching circuits.

## Absolute Maximum Ratings

Symbol	Parameter	Rating	Units
$V_{DS}$	Drain-Source Voltage	700	V
$V_{GS}$	Gate-Source Voltage	$\pm 30$	V
$I_D @ T_C = 25^\circ C$	Continuous Drain Current, $V_{GS} @ 10V$	4	A
$I_D @ T_C = 100^\circ C$	Continuous Drain Current, $V_{GS} @ 10V$	2.5	A
$I_{DM}$	Pulsed Drain Current <sup>1</sup>	15	A
$P_D @ T_C = 25^\circ C$	Total Power Dissipation	33	W
	Linear Derating Factor	0.26	W/ $^\circ C$
$E_{AS}$	Single Pulse Avalanche Energy <sup>2</sup>	100	mJ
$I_{AR}$	Avalanche Current	4	A
$E_{AR}$	Repetitive Avalanche Energy	4	mJ
$T_{STG}$	Storage Temperature Range	-55 to 150	$^\circ C$
$T_J$	Operating Junction Temperature Range	-55 to 150	$^\circ C$

## Thermal Data

Symbol	Parameter	Value	Units
Rthj-c	Thermal Resistance Junction-case	Max. 3.8	$^\circ C/W$
Rthj-a	Thermal Resistance Junction-ambient	Max. 65	$^\circ C/W$



**Electrical Characteristics @T<sub>j</sub>=25°C(unless otherwise specified)**

Symbol	Parameter	Test Conditions	Min.	Typ.	Max.	Units
BV <sub>DSS</sub>	Drain-Source Breakdown Voltage	V <sub>GS</sub> =0V, I <sub>D</sub> =1mA	700	-	-	V
ΔBV <sub>DSS</sub> /ΔT <sub>j</sub>	Breakdown Voltage Temperature Coefficient	Reference to 25°C, I <sub>D</sub> =1mA	-	0.6	-	V/°C
R <sub>DS(ON)</sub>	Static Drain-Source On-Resistance	V <sub>GS</sub> =10V, I <sub>D</sub> =2A	-	-	2.4	Ω
V <sub>GS(th)</sub>	Gate Threshold Voltage	V <sub>DS</sub> =V <sub>GS</sub> , I <sub>D</sub> =250uA	2	-	4	V
g <sub>fs</sub>	Forward Transconductance	V <sub>DS</sub> =10V, I <sub>D</sub> =2A	-	2.5	-	S
I <sub>DSS</sub>	Drain-Source Leakage Current (T <sub>j</sub> =25°C)	V <sub>DS</sub> =600V, V <sub>GS</sub> =0V	-	-	10	uA
	Drain-Source Leakage Current (T <sub>j</sub> =150°C)	V <sub>DS</sub> =480V, V <sub>GS</sub> =0V	-	-	100	uA
I <sub>GSS</sub>	Gate-Source Leakage	V <sub>GS</sub> =±30V	-	-	±100	nA
Q <sub>g</sub>	Total Gate Charge <sup>3</sup>	I <sub>D</sub> =4A	-	16.7	-	nC
Q <sub>gs</sub>	Gate-Source Charge	V <sub>DS</sub> =480V	-	4.1	-	nC
Q <sub>gd</sub>	Gate-Drain ("Miller") Charge	V <sub>GS</sub> =10V	-	4.9	-	nC
t <sub>d(on)</sub>	Turn-on Delay Time <sup>3</sup>	V <sub>DD</sub> =300V	-	11	-	ns
t <sub>r</sub>	Rise Time	I <sub>D</sub> =4A	-	8.3	-	ns
t <sub>d(off)</sub>	Turn-off Delay Time	R <sub>G</sub> =10Ω, V <sub>GS</sub> =10V	-	23.8	-	ns
t <sub>f</sub>	Fall Time	R <sub>D</sub> =75Ω	-	8.2	-	ns
C <sub>iss</sub>	Input Capacitance	V <sub>GS</sub> =0V	-	950	-	pF
C <sub>OSS</sub>	Output Capacitance	V <sub>DS</sub> =25V	-	65	-	pF
C <sub>rss</sub>	Reverse Transfer Capacitance	f=1.0MHz	-	6	-	pF

**Source-Drain Diode**

Symbol	Parameter	Test Conditions	Min.	Typ.	Max.	Units
I <sub>S</sub>	Continuous Source Current ( Body Diode )	V <sub>D</sub> =V <sub>G</sub> =0V , V <sub>S</sub> =1.5V	-	-	4	A
I <sub>SM</sub>	Pulsed Source Current ( Body Diode ) <sup>1</sup>		-	-	15	A
V <sub>SD</sub>	Forward On Voltage <sup>3</sup>	T <sub>j</sub> =25°C, I <sub>S</sub> =4A, V <sub>GS</sub> =0V	-	-	1.5	V

**Notes:**

- 1.Pulse width limited by safe operating area.
- 2.Starting T<sub>j</sub>=25°C , V<sub>DD</sub>=50V , L=25mH , R<sub>G</sub>=25Ω , I<sub>AS</sub>=4A.
- 3.Pulse width ≤300us , duty cycle ≤2%.

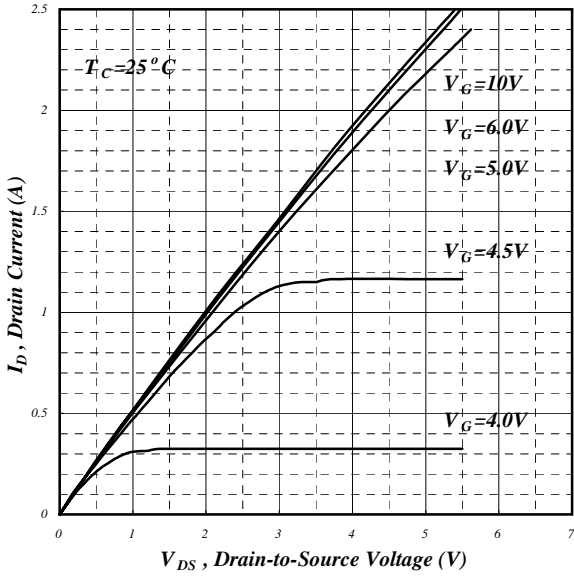

Fig 1. Typical Output Characteristics

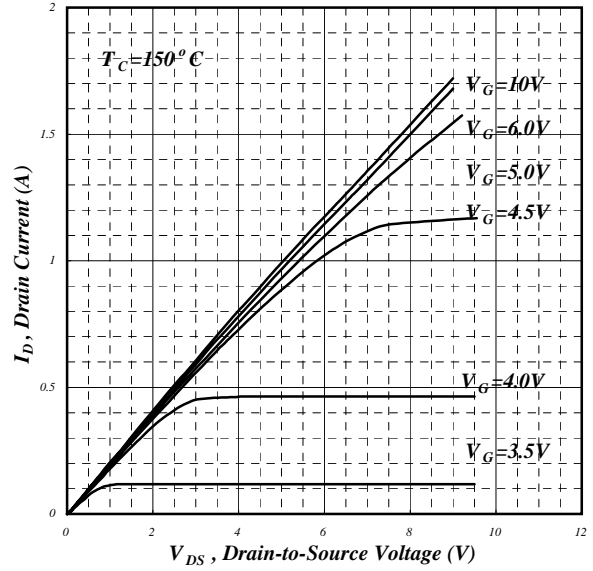

Fig 2. Typical Output Characteristics

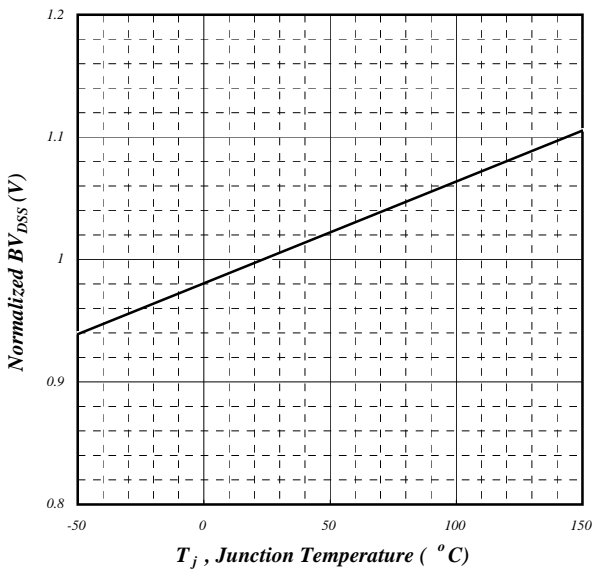

Fig 3. Normalized  $BV_{DSS}$  v.s. Junction Temperature

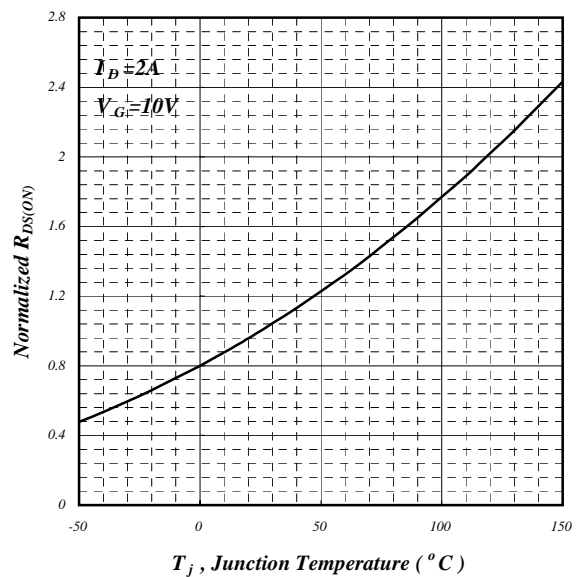

Fig 4. Normalized On-Resistance v.s. Junction Temperature



# AP04N70BF-H

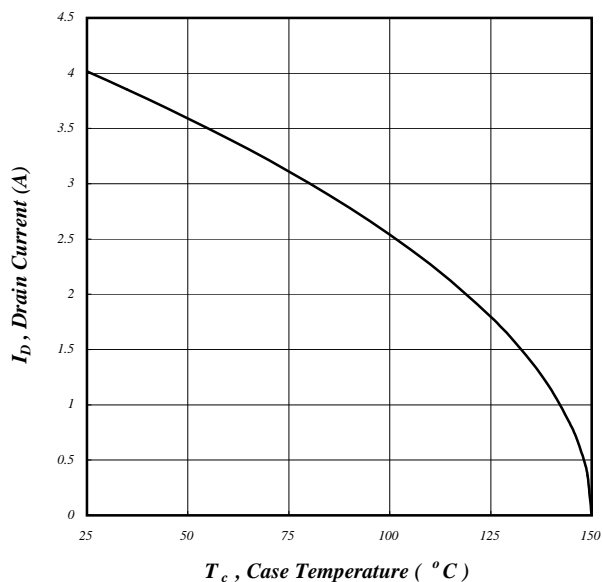

Fig 5. Maximum Drain Current v.s. Case Temperature

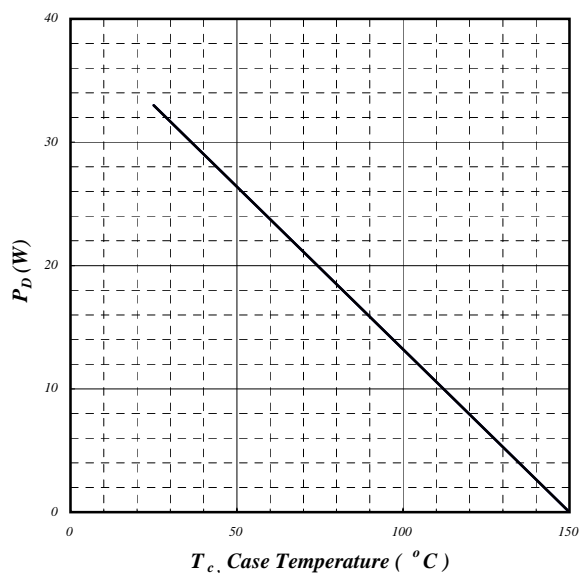

Fig 6. Typical Power Dissipation

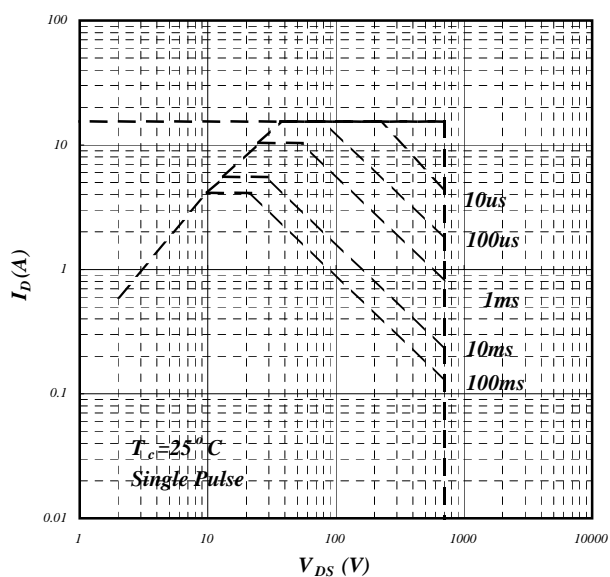

Fig 7. Maximum Safe Operating Area

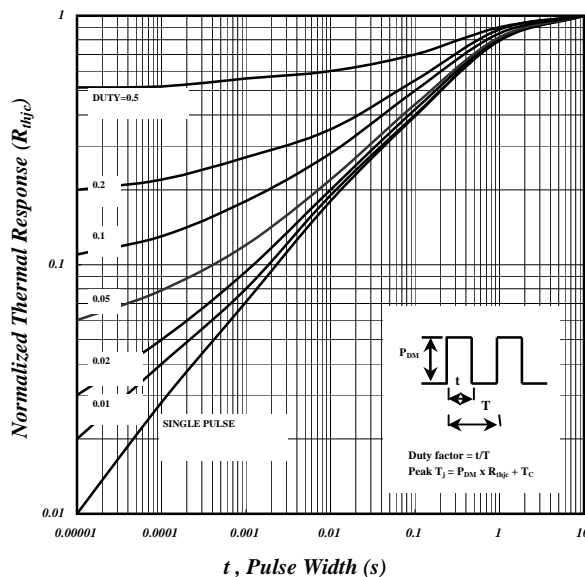

Fig 8. Effective Transient Thermal Impedance

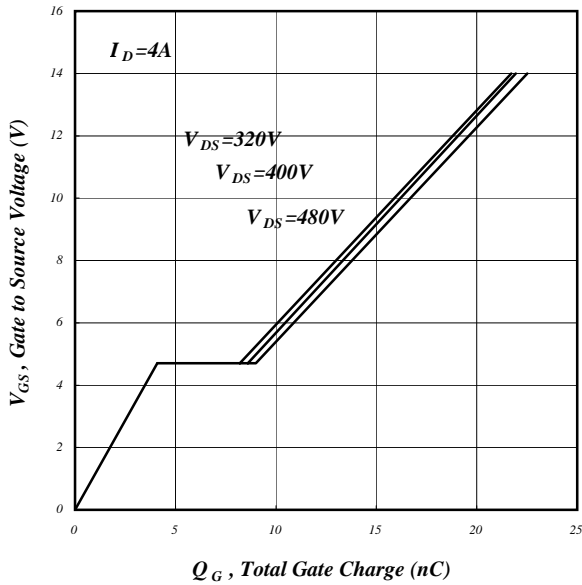

Fig 9. Gate Charge Characteristics

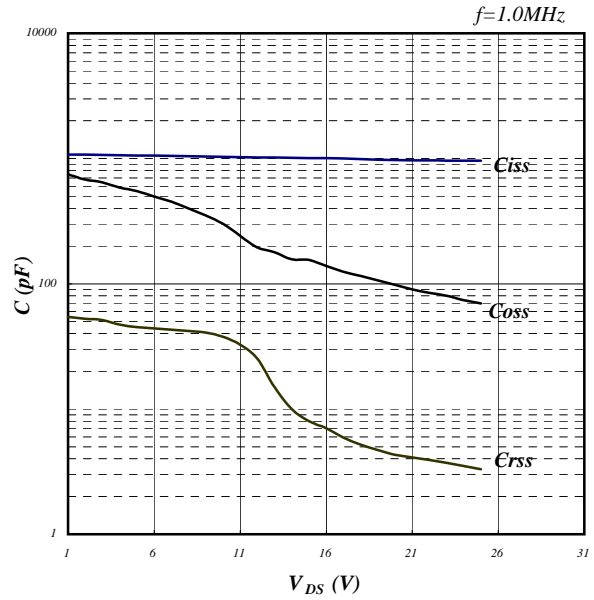

Fig 10. Typical Capacitance Characteristics

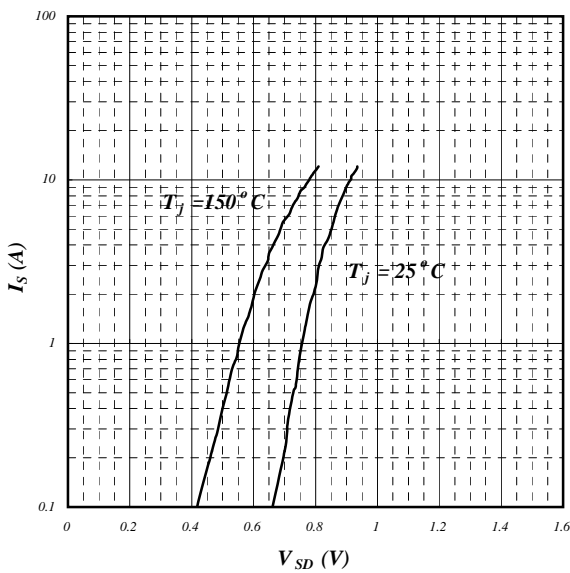

Fig 11. Forward Characteristic of Reverse Diode

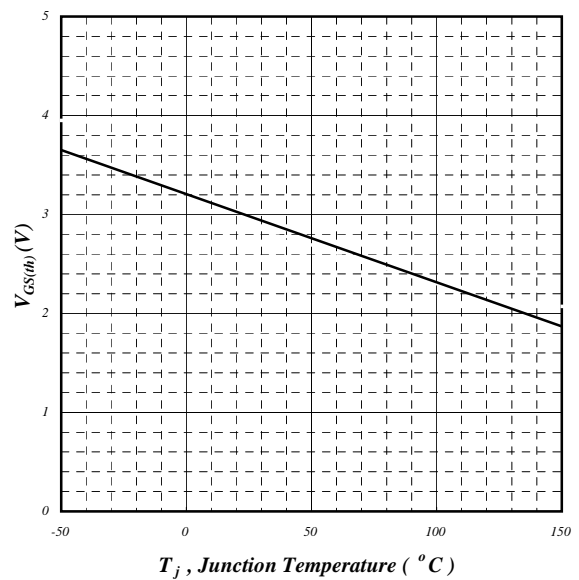

Fig 12. Gate Threshold Voltage v.s. Junction Temperature



# AP04N70BF-H

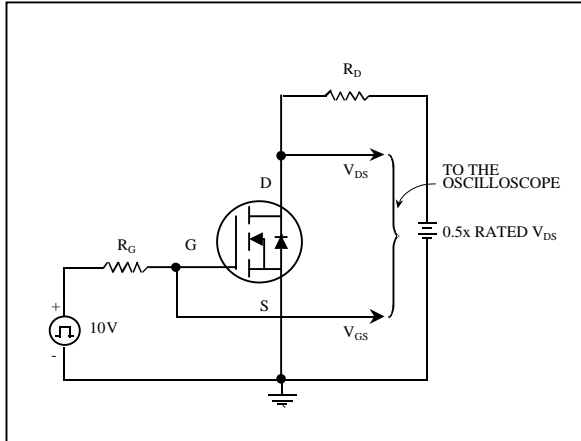

Fig 13. Switching Time Circuit

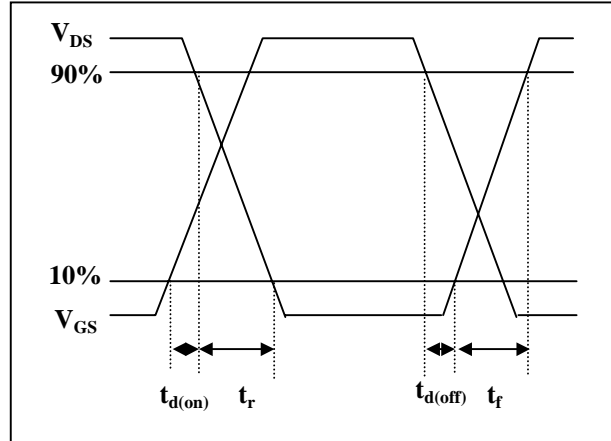

Fig 14. Switching Time Waveform

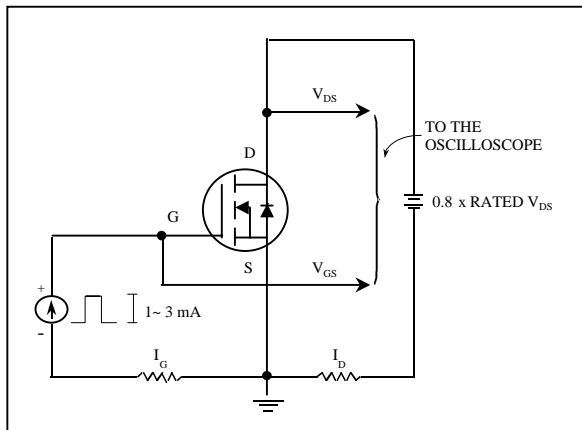

Fig 15. Gate Charge Circuit

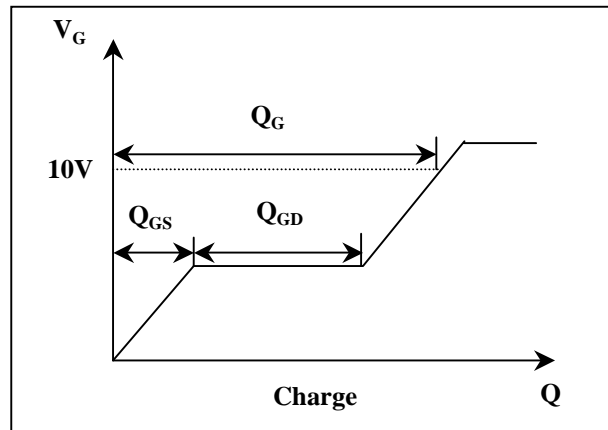

Fig 16. Gate Charge Waveform