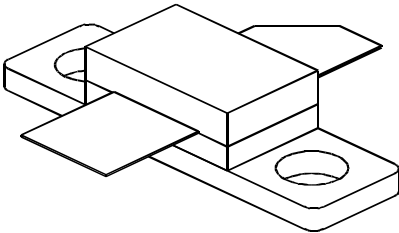

0912-7

7 Watts, 50 Volts, Pulsed
Avionics 960 - 1215 MHz

<p>GENERAL DESCRIPTION</p> <p>The 0912-7 is a COMMON BASE bipolar transistor. It is designed for pulsed systems in the frequency band 960-1215 MHz. The transistor includes input prematch for broadband capability. The device has gold thin-film metallization for proven highest MTTF. Low thermal resistance package reduces junction temperature, extends life.</p>	<p>CASE OUTLINE 55CX, STYLE 1</p> 
<p>ABSOLUTE MAXIMUM RATINGS</p> <p>Maximum Power Dissipation @ 25°C² 50 Watts</p> <p>Maximum Voltage and Current</p> <p>BVces Collector to Emitter Voltage 60 Volts BVebo Emitter to Base Voltage 4.0 Volts Ic Collector Current 1.0 Amps</p> <p>Maximum Temperatures</p> <p>Storage Temperature - 65 to + 150 °C Operating Junction Temperature + 200°C</p>	

ELECTRICAL CHARACTERISTICS @ 25 °C

SYMBOL	CHARACTERISTICS	TEST CONDITIONS	MIN	TYP	MAX	UNITS
Pout	Power Out	F = 960-1215 MHz	7			Watts
Pin	Power Input	Vcc = 50 Volts			1	Watts
Pg	Power Gain	PW = 10 µsec	8.5			d B
η_c	Collector Efficiency (1090 MHz)	DF = 1%		40		%
VSWR	Load Mismatch Tolerance	F = 1090 MHz			10:1	
BVebo	Emitter to Base Breakdown	Ie = 10 mA	4			Volts
BVces	Collector to Emitter Breakdown	Ic = 20 mA	60			Volts
Cob	Capacitance Collector to Base	Vcb = 50 V		6.5	8	pF
h_{FE}	DC - Current Gain	Ic = 100 mA, Vcc = 5V	10		120	
θ_{jc}^2	Thermal Resistance				3.5	°C/W

Note1: At Rated Power Output and pulse conditions.

2: At rated pulse conditions

Issue A February 20, 1998

GHZ TECHNOLOGY INC. RESERVES THE RIGHT TO MAKE CHANGES WITHOUT FURTHER NOTICE. GHZ RECOMMENDS THAT BEFORE THE PRODUCT(S) DESCRIBED HEREIN ARE WRITTEN INTO SPECIFICATIONS, OR USED IN CRITICAL APPLICATIONS, THAT THE PERFORMANCE CHARACTERISTICS BE VERIFIED BY CONTACTING THE FACTORY.

GHZ Technology Inc. 3000 Oakmead Village Drive, Santa Clara, CA 95051-0808 Tel. 408 / 986-8031 Fax 408 / 986-8120



GHz TECHNOLOGY
RF · MICROWAVE · SILICON POWER TRANSISTORS

0912-7

BROADBAND Pout & RETURN LOSS

Pin = 1 Watt Pk, Vcc = 50 Volts

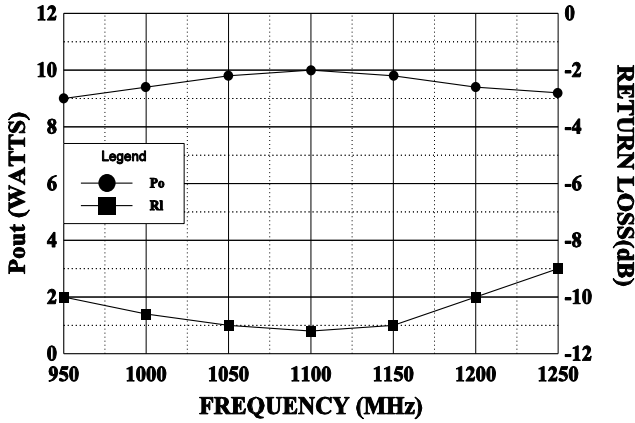

POWER OUTPUT vs POWER INPUT

Vcc = 50V, Frequency 1090 MHz

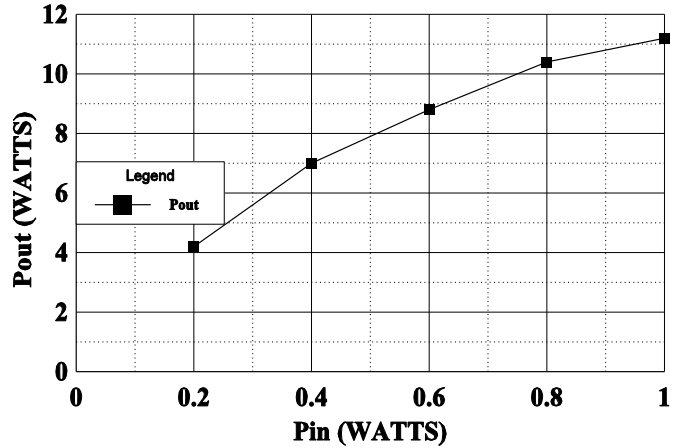

EFFICIENCY vs FREQUENCY

Vcc 50 Volts, Pin = 1 Watt

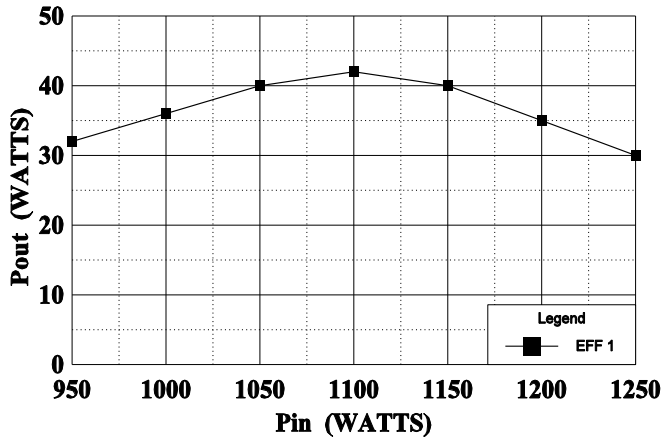

SERIES INPUT IMPEDANCE vs FREQUENCY

Vcc = 50 V, Pin = 1 W

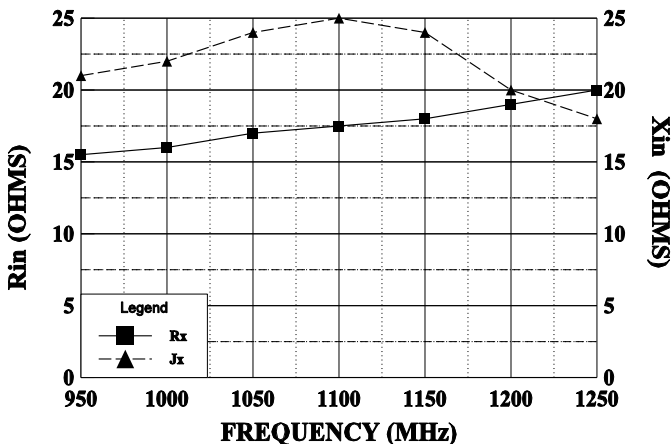

SERIES LOAD IMPEDANCE vs FREQUENCY

Vcc = 50 V, Pin = 1W

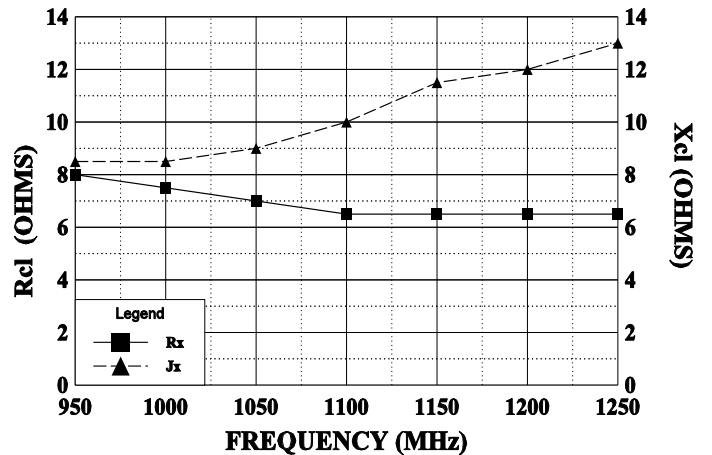

0912-7 CIRCUIT

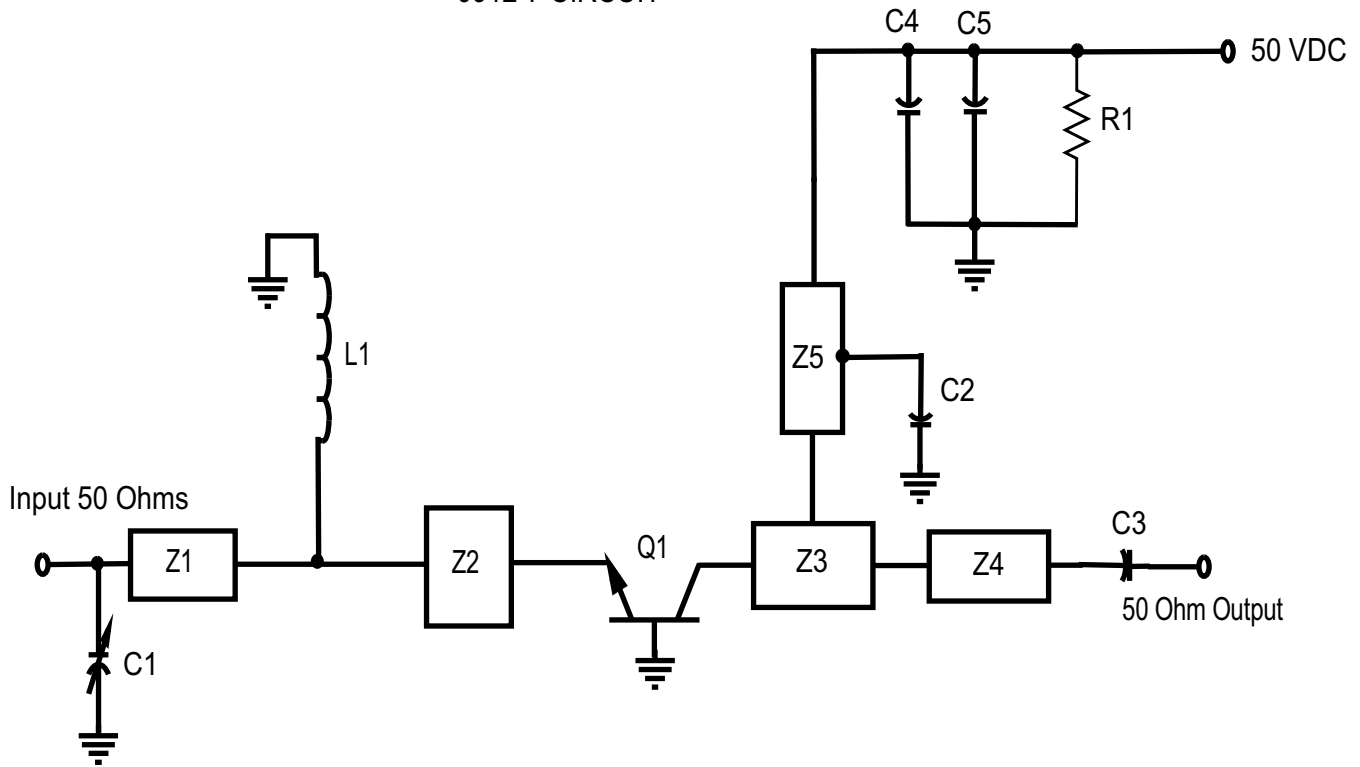

PC Board Material .010" Dielectric Teflon Fiberglass

Z1=50 , .062 , =.027"w X .45"L
 Z2=5 , .033 , =.43"w X .23"L
 Z3=10 , .06 , =.20"w X .40"L
 Z4=50 = .027"w X any convenient length
 Z5=50 , .12 , =.027"w X .86"L
 C1=Capacitor, .35-3.5pF Piston Trimmer
 C2=Capacitor, 47pF ATC

Note: Slide C2 along Z5 for best tuning
 C3=Capacitor, 47pF ATC
 C4=Capacitor, 100 pF ATC
 C5=Capacitor, 12mfd, 75 VDC, Electrolytic
 L1=Inductor, #18 wire, 1.5" long
 R1=Resistor, 10KW, 1/4W
 Q1=Transistor, GHz 0912-7

All electrical lengths taken at 1.09 GHz