

SILICON RECTIFIER

VOLTAGE RANGE 50 to 1000 Volts CURRENT 10 Amperes

FEATURES

- * High surge current capability
- * Low leakage
- * Low forward voltage drop
- * High current capability
- * Low lost

MECHANICAL DATA

- * Case: Molded plastic black body
- * Epoxy: Device has UL flammability classification 94V-O
- * Lead: MIL-STD-202E method 208C guaranteed
- * Mounting position: Any
- * Weight: 2.08 gram

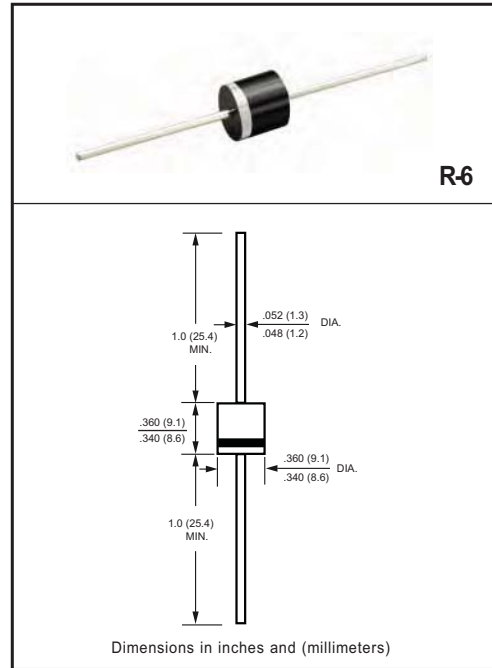

MAXIMUM RATINGS AND ELECTRICAL CHARACTERISTICS

Ratings at 25 °C ambient temperature unless otherwise specified.
Single phase, half wave, 60 Hz, resistive or inductive load.
For capacitive load, derate current by 20%.

MAXIMUM RATINGS (@ TA=25 °C unless otherwise noted)

RATINGS	SYMBOL	10A05	10A1	10A2	10A4	10A6	10A8	10A10	UNITS	
Maximum Recurrent Peak Reverse Voltage	V _{RRM}	50	100	200	400	600	800	1000	Volts	
Maximum RMS Voltage	V _{RMS}	35	70	140	280	420	560	700	Volts	
Maximum DC Blocking Voltage	V _{DC}	50	100	200	400	600	800	1000	Volts	
Maximum Average Forward Rectified Current at TA = 50°C	I _O					10				Amps
Peak Forward Surge Current I _{FM} (surge): 8.3 ms single half sine-wave superimposed on rated load (JEDEC method)	I _{FSM}					400				Amps
Typical Current Squared Time	i ² T					664				A ² S
Typical Thermal Resistance (Note 3)	R _{θJA}					20				°C/W
Typical Thermal Resistance (Note 4)	R _{θJL}					4				°C/W
Typical Thermal Resistance (Note 5)	R _{θJC}					6				°C/W
Typical Junction Capacitance (Note 1)	C _J					135				pF
Operating and Storage Temperature Range	T _J , T _{STG}					-55 to + 150			°C	

ELECTRICAL CHARACTERISTICS (@TA=25 °C unless otherwise noted)

CHARACTERISTICS	SYMBOL	10A05	10A1	10A2	10A4	10A6	10A8	10A10	UNITS	
Maximum Forward Voltage at 10A DC	V _F					1.1				Volts
Maximum DC Average Reverse Current at Rated DC Blocking Voltage	@T _A = 25°C					5				uAmps
	@T _A = 100°C					100				
Maximum Full Load Reverse Current Average Full Cycle .375" (9.5mm) Lead Length at T _L =75°C						50				

- NOTES : 1. Measured at 1.0 MHz and applied average voltage of 4.0VDC
 2. "Fully ROHS compliant", "100% Sn plating (Pb-free)".
 3. Thermal Resistance: At 9.5mm lead lengths, PCB mounted.
 4. Thermal Resistance Junction to lead
 5. Thermal Resistance Junction to dice

RATING AND CHARACTERISTICS CURVES (10A05 THRU 10A10)

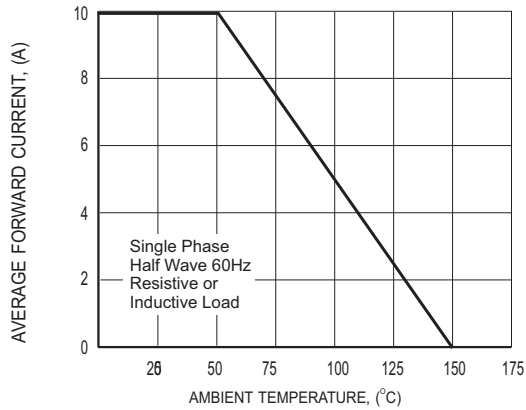

FIG.1 TYPICAL FORWARD CURRENT DERATING CURVE

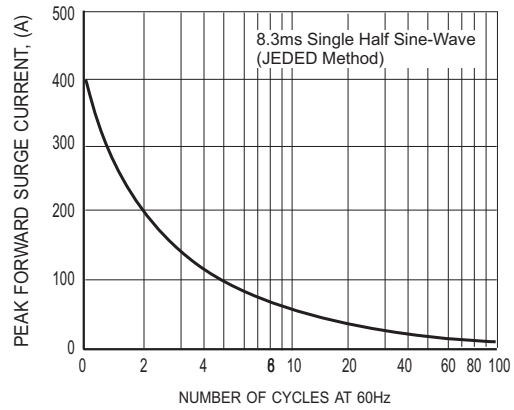

FIG.2 MAXIMUM NON-REPETITIVE FORWARD SURGE CURRENT

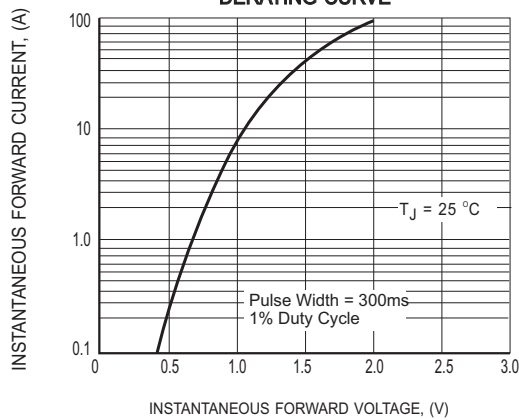

FIG.3 TYPICAL INSTANTANEOUS FORWARD CHARACTERISTICS

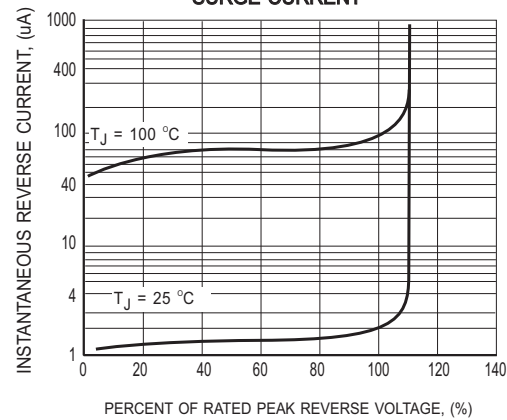

FIG.4 TYPICAL REVERSE CHARACTERISTICS

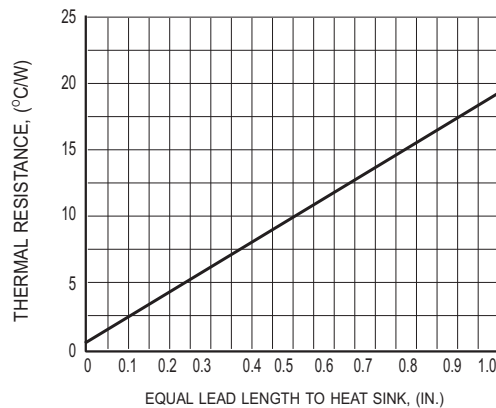

FIG.5 TYPICAL THERMAL RESISTANCE vs. LEAD LENGTH



Attachment information about 10AX

1. Internal Circuit



2. Marking on the body

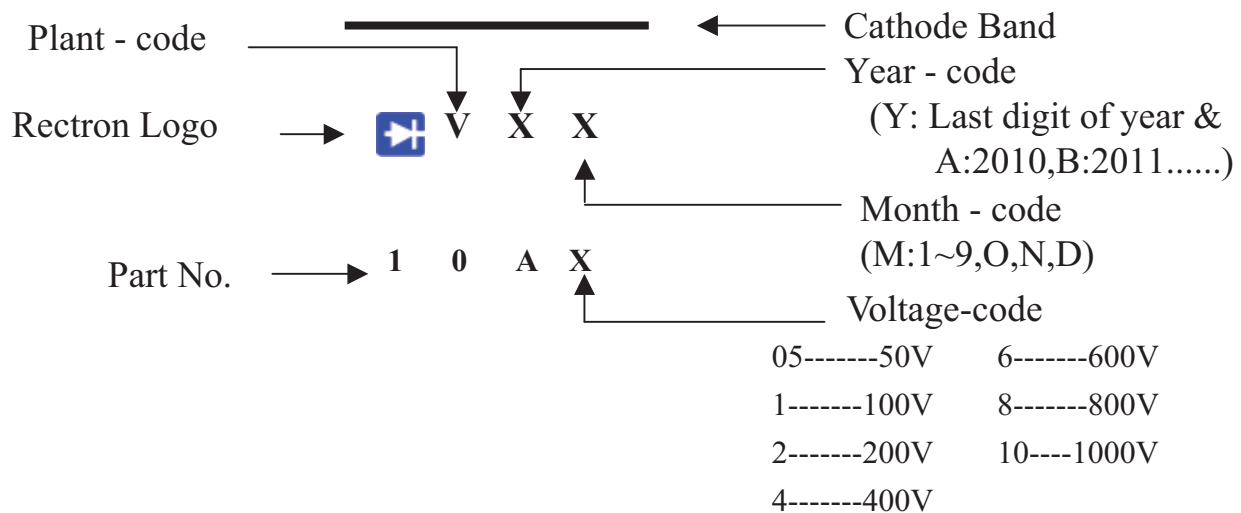

PACKAGING OF DIODE AND BRIDGE RECTIFIERS

BULK PACK

PACKAGE	PACKING CODE	EA PER BOX	INNER BOX SIZE (mm)	CARTON SIZE (mm)	EA PER CARTON	GROSS WEIGHT(Kg)
R-6/R-7	-B	200	300*73*40	347*320*271	4,800	12.93/14.57

REEL PACK

PACKAGE	PACKING CODE	EA PER REEL	EA PER INNER BOX	COMPONENT SPACE (mm)	TAPE SPACE (mm)	REEL DIA (mm)	CARTON SIZE (mm)	EA PER CARTON	GROSS WEIGHT(Kg)
R-6/R-7	-T	800	800	9.5	52	330	355*350*335	3,200	9.72/9.91

AMMO PACK

PACKAGE	PACKING CODE	REEL (EA)	COMPONENT SPACE(mm)	TAPE SPACE (mm)	BOX SIZE (mm)	CARTON SIZE(mm)	CARTON (EA)	GROSS WEIGHT (Kg)
R-6/R-7	-F	300	9.5	52	255*73*100	400*268*225	3,000	8.5/8.7

DISCLAIMER NOTICE

Rectron Inc reserves the right to make changes without notice to any product specification herein, to make corrections, modifications, enhancements or other changes. Rectron Inc or anyone on its behalf assumes no responsibility or liability for any errors or inaccuracies. Data sheet specifications and its information contained are intended to provide a product description only. "Typical" parameters which may be included on RECTRON data sheets and/ or specifications can and do vary in different applications and actual performance may vary over time. Rectron Inc does not assume any liability arising out of the application or use of any product or circuit.

Rectron products are not designed, intended or authorized for use in medical, life-saving implant or other applications intended for life-sustaining or other related applications where a failure or malfunction of component or circuitry may directly or indirectly cause injury or threaten a life without expressed written approval of Rectron Inc. Customers using or selling Rectron components for use in such applications do so at their own risk and shall agree to fully indemnify Rectron Inc and its subsidiaries harmless against all claims, damages and expenditures.