

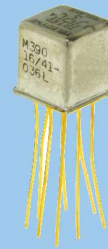

## CENTIGRID® ESTABLISHED RELIABILITY MILITARY SENSITIVE DPDT



SERIES	RELAY TYPE
134	DPDT basic relay
134D	DPDT relay with internal diode for coil transient suppression
134DD	DPDT relay with internal diodes for coil transient suppression and polarity reversal protection

### DESCRIPTION

The 134 sensitive Centigrid® relay retains the same features as the 114 standard Centigrid® relay with only a minimal increase in profile height (.375 in.). Its .100-inch grid spaced terminals, which preclude the need for spreader pads, and its low profile make the 134 relay ideal for applications where high packaging density is important.

The following unique construction features and manufacturing techniques provide excellent resistance to environmental extremes and overall high reliability:

#### The 134 feature:

- All welded construction.
- Advanced cleaning techniques provide maximum assurance of internal cleanliness.
- Unique uni-frame design providing high magnetic efficiency and mechanical rigidity.

- High force/mass ratios for resistance to shock and vibration.
- Precious metal alloy contact material with gold plating assures excellent high current and dry circuit switching capabilities.

The Series 134D and 134DD have internal discrete silicon diodes for coil suppression and polarity reversal protection.

The sensitive 134 Centigrid® relay has a high resistance coil, thus requiring extremely low operating power (200 mW typical). The advantages of reduced heat dissipation and power supply demands are a plus.

By virtue of its inherently low intercontact capacitance and contact circuit losses, the 134 relay has proven to be an excellent ultraminiature RF switch for frequency ranges well into the UHF spectrum. A typical RF application for the Centigrid® relay is in handheld radio transceivers, wherein the combined features of good RF performance, small size, low coil power dissipation and high reliability make it a preferred method of Transmit-Receive switching

ENVIRONMENTAL AND PHYSICAL SPECIFICATIONS	
<b>Temperature</b> (Ambient)	-65°C to +125°C
<b>Vibration</b> (General Note I)	30 g's to 3000 Hz
<b>Shock</b> (General Note I)	50 g's, 6ms half sine
<b>Acceleration</b>	50 g's
<b>Enclosure</b>	Hermetically sealed
<b>Weight</b>	0.15 oz. (4.3g) max.
<b>Reflow Temperature</b>	260°C max. temp. 1 min. max

### INTERNAL CONSTRUCTION

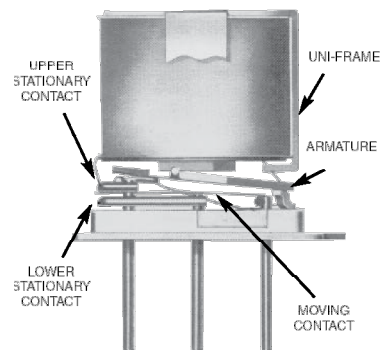

**SERIES 134**  
**GENERAL ELECTRICAL SPECIFICATIONS (@25°C)**

<b>Contact Arrangement</b>		2 Form C (DPDT)
<b>Rated Duty</b>		Continuous
<b>Contact Resistance</b>		0.10 Ω max.
<b>Contact Load Rating (DC)</b>		Resistive: 1 A / 28 Vdc Inductive: 200 mA / 28 Vdc (320mH) Lamp: 100 mA / 28 Vdc (320mH) Low level: 10 to 50 μA @ 10 to 50 mV
<b>Contact Load Rating (AC)</b>		Resistive: 250 mA / 115Vac, 60 and 400 Hz (Case not grounded) 100 mA / 115 Vac, 60 and 400 Hz (Case grounded)
<b>Contact Life Ratings</b>		10,000,000 cycles (typical) at low level 1,000,000 cycles (typical) at 0.5 A / 28 Vdc resistive 100,000 cycles min. at all other loads specified above
<b>Contact Overload Rating</b>		2 A / 28 Vdc Resistive (100 cycles min.)
<b>Coil Operating Power</b>		200 mW typical at nominal rated voltage
<b>Contact Carry Rating</b>		Contact Factory
<b>Operate Time</b>		4.0 msec max. at nominal rated coil voltage
<b>Release Time</b>	<b>134</b>	2.0 ms max.
	<b>134D</b>	7.5 ms max.
	<b>134DD</b>	
<b>Contact Bounce</b>		1.5 msec max.
<b>Intercontact Capacitance</b>		0.4 pf typical
<b>Insulation Resistance</b>		10,000 MΩ min. between mutually isolated terminals
<b>Dielectric Strength (Vrms/60)</b>		Atmospheric pressure: 500 70,000 ft: 125
<b>Negative Coil Transient (Vdc)</b>	<b>134D</b> <b>134DD</b>	1.0 Vdc Max.
<b>Diode P.I.V. (Vdc)</b>	<b>134D</b> <b>134DD</b>	100 Vdc Min.

**PERFORMANCE CURVES (Note 2)**

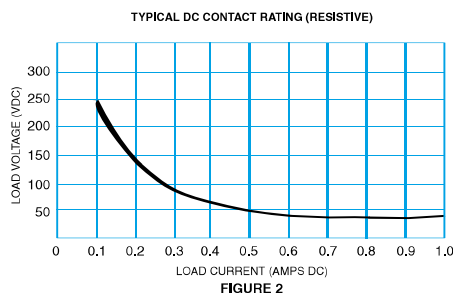
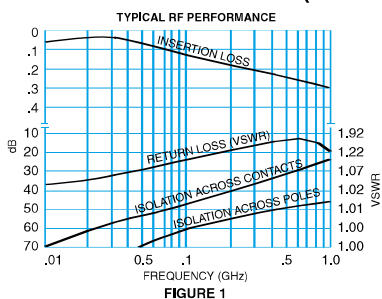

**GENERAL NOTES**

1. Relay contacts will exhibit no chatter in excess of 10 μsec or transfer in excess of 1 μsec.
2. "Typical" characteristics are based on available data and are best estimates. No on-going verification tests are performed.
3. Unless otherwise specified, parameters are initial values.
4. Relays can be supplied with a spacer pad. See appendix.

### 134 Series

#### DETAILED ELECTRICAL SPECIFICATIONS (@25°C)

BASE PART NUMBERS (134, 134D, 134DD)		134-5 134D-5 134DD-5	134-12 134D-12 134DD-12	134-26 134D-26 134DD-26
Coil Voltage	Nom.	5.0	12.0	26.5
	Max.	7.5	20.0	40.0
Coil Resistance (Ohms ±10% @25°C)	134, 134D	100	800	3200
	134D	64	800	3200
Coil Current (134DD) (mAdc@25°C)	(Note 5)	Min.	56.8	12.5
		Max.	78.1	16.0
Pick-up Voltage (Vdc, Max)	134 134D	3.5	9.0	18.0
	134DD	3.7	11.0	19.0
Drop-out Voltage (Vdc)	134, 134D	Min.	0.12	0.41
		Max.	2.5	6.5
	134DD	Min.	0.7	1.0
		Max.	2.6	5.8

#### NOTES:

1. Relay contacts will exhibit no chatter in excess of 10 µsec or transfer in excess of 1 µsec.
2. "Typical" characteristics are based on available data and are best estimates. No on-going verification tests are performed.
3. Unless otherwise specified, parameters are initial values.
4. For reference only. Coil resistance not directly measurable at relay terminals due to internal series semiconductor, 134DD only
5. Unless otherwise specified, relays will be supplied with either gold-plated or solder-coated leads.
6. The slash and characters appearing after the slash are not marked on the relay.
7. Limit Base Emitter current to 15 mAdc.
8. Applicable to all coil voltages. See Base current to turn on.
9. Screened HI-REL versions available. Contact factory.

**SERIES 134  
OUTLINE DIMENSIONS**

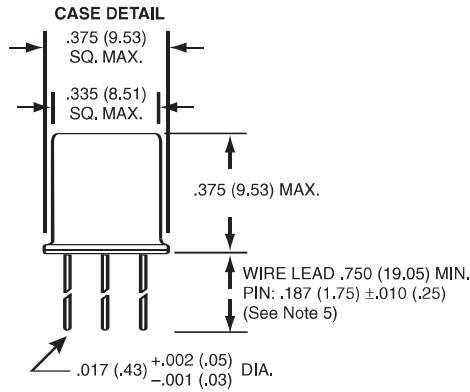

Dimensions: in. (mm)

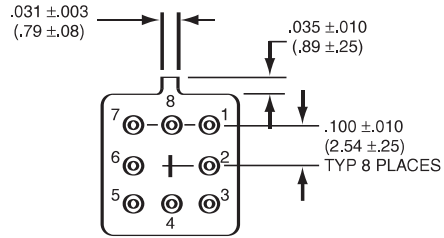

(Viewed From Terminals)

**SCHEMATIC DIAGRAMS**

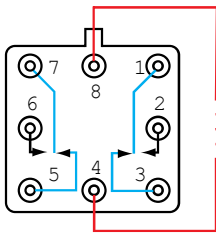

134

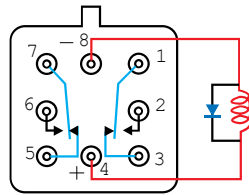

134D

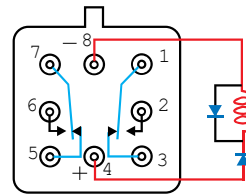

134DD

**Part Numbering System**

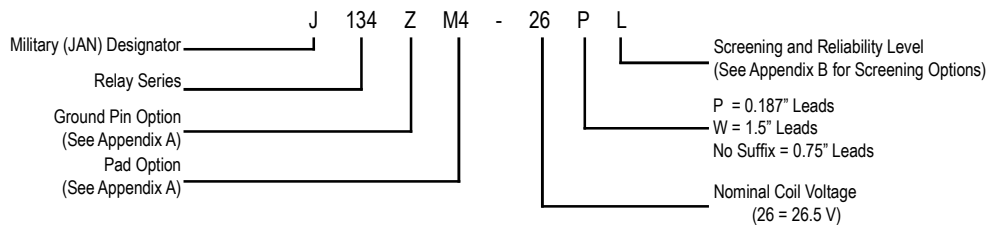
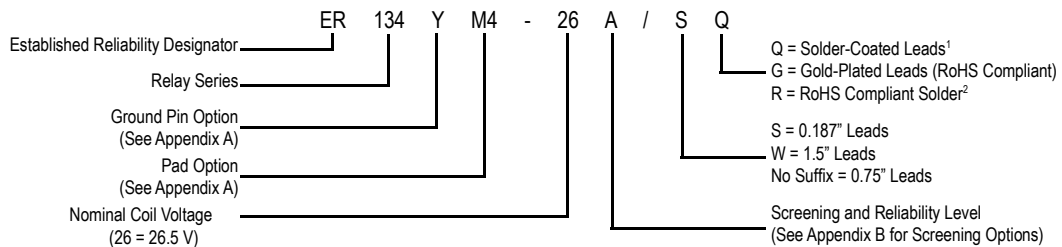

## APPENDIX A : Spacer Pads

Pad designation and bottom view dimensions	Height	For use with the following:	Dim. H Max.
 <p style="text-align: center;"><b>"M4" Spacer Pad for TO-5</b></p>		ER412	.295 (7.49)
		712, RF300, RF, RF700, RF703	.300 (7.62)
		ER422, 722	.305 (7.75)
		ER432	.400 (10.16)
		732, RF303	.410 (10.41)
		RF312	.350 (8.89)
 <p style="text-align: center;"><b>"M4" Spacer Pad for TO-5</b></p>		ER411	.295 (7.49)
		RF311	.300 (7.62)
		RF331	.410 (10.41)
 <p style="text-align: center;"><b>"M4" Spacer Pad for Centigrid®</b></p>		172	.305 (7.75)
		ER114, J114	.300 (7.62)
		ER134, J134	.400 (10.16)
		RF100	.315 (8.00)
		RF103	.420 (10.67)
 <p style="text-align: center;"><b>"M9" Spacer Pad for Centigrid®</b></p>		122C, A152	.320 (8.13)
		ER116C, J116C	.300 (7.62)
		ER136C, J136C	.400 (10.16)
		RF180	.325 (8.25)
		A150	.305 (7.75)

**Notes:**

1. Spacer pad material: Polyester film.
2. To specify an "M4" or "M9" spacer pad, refer to the mounting variants portion of the part numbering example in the applicable datasheet.
3. Dimensions are in inches (mm).
4. Unless otherwise specified, tolerance is  $\pm .010$ " (.25 mm).
5. Add 10 m $\Omega$  to the contact resistance shown in the datasheet.
6. Add 0.01 oz. (0.25 g) to the weight of the relay assembly shown in the datasheet.

## APPENDIX A : Spreader Pads

Pad designation and bottom view dimensions	Height	For use with the following:	Dim. H Max.
 <p style="text-align: center;">"M" Spreader Pad <u>5/</u> <u>6/</u></p>		ER411T, ER412, J412	.388 (9.86)
		712	.393 (9.99)
		ER432, J432	.493 (12.52)
		732	.503 (12.78)
		J421, J422, ER422, 722	.398 (10.11)

**Notes:**

1. Spreader pad material: Diallyl Phthalate.
2. To specify an "M", "M2" or "M3" spreader pad, refer to the mounting variants portion of the part number example in the applicable datasheet.
3. Dimensions are in inches (mm).
4. Unless otherwise specified, tolerance is  $\pm .010$ " (0.25 mm).
- 5/. Add 25 m $\Omega$  to the contact resistance shown in the datasheet.
- 6/. Add .01 oz. (0.25 g) to the weight of the relay assembly shown in the datasheet.
- 7/. Add 50 m $\Omega$  to the contact resistance shown in the datasheet.
- 8/. Add 0.025 oz (0.71 g) to the weight of the relay assembly shown in the datasheet.
- 9/. M3 pad to be used only when the relay has a center pin (e.g. ER411M3-12A, 722XM3-26.)

# APPENDIX A : Ground Pin Positions

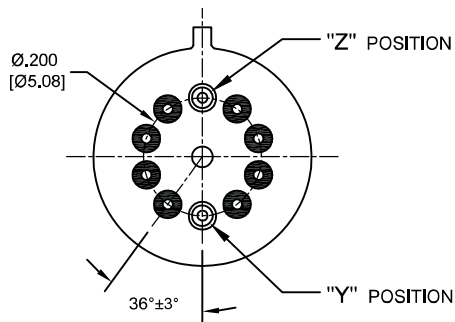

**TO-5 Relays:**

ER412, ER412T, ER422, ER432, ER432T, 712, 712TN, 400H, 400K, 400V, RF300, RF303, RF341, RF312, RF332, RF310, RF313, RF320, RF323, SI800, SI803, RF700, RF703

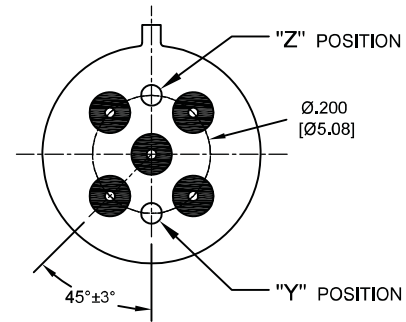

**TO-5 Relays:**

ER411, RF311, RF331



**Centigrid® Relays:**

RF180, ER116C, 122C, ER136C



**Centigrid® Relays:**

RF100, RF103, ER114, ER134, 172

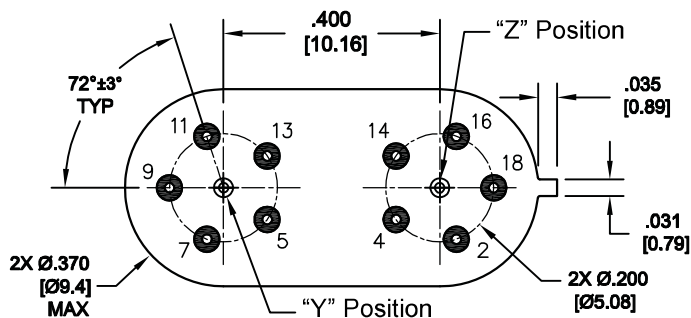

**Loopback Relays:**

LB363

- Indicates ground pin position
- Indicates glass insulated lead position
- ◎ Indicates ground pin or lead position depending on relay type

**NOTES**

1. Terminal views shown
2. Dimensions are in inches (mm)
3. Tolerances: ± .010 (±.25) unless otherwise specified
4. Ground pin positions are within .015 (0.38) dia. of true position
5. Ground pin head dia., 0.035 (0.89) ref: height 0.010 (0.25) ref.
6. Lead dia. 0.017 (0.43) nom.