

Mechanical Dimensions

| REV. | DESCRIPTION | DATE | DWN | AP'PD |
|------|-------------|------|-----|-------|
| | | | | |
| | | | | |

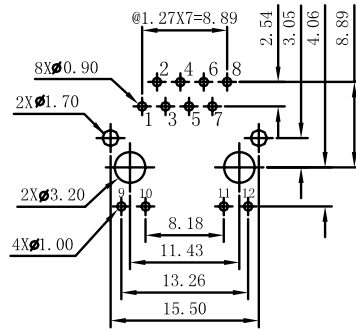

PC Board Layout
Component Side Shown

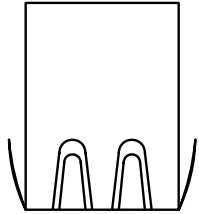
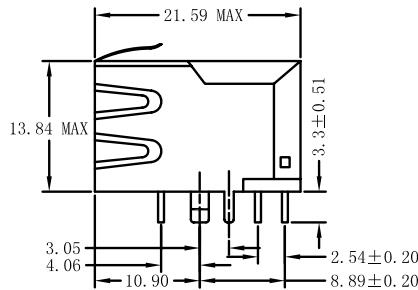
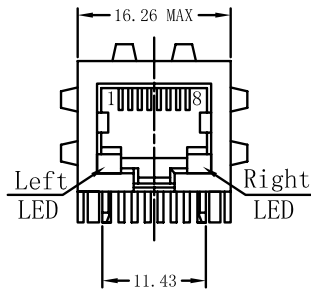

UNIT: mm Unless otherwise specified, all tolerances are \pm 0.25

ELECTRICAL SPECIFICATIONS @25°C:

Turn Ratio(\pm 5%):1CT:1CT

Inductance(100KHz/0.1V@8mA):350uH MIN

Cw/w(100KHz/0.1V):28pF MAX

Insertion Loss (dB MAX):-1.0dB(1-100MHz)

Return Loss (dB MIN):

-18dB(1-30MHz), -16dB(40MHz), -14dB(50MHz), -12dB(60-80MHz)

Cross talk(dB MIN):-35dB(1-80MHz)

HI-POT:1500Vrms/0.5mA/2Sec

Operating Temperature:0°C TO +70°C

RoHS compliance:YES

Schematics

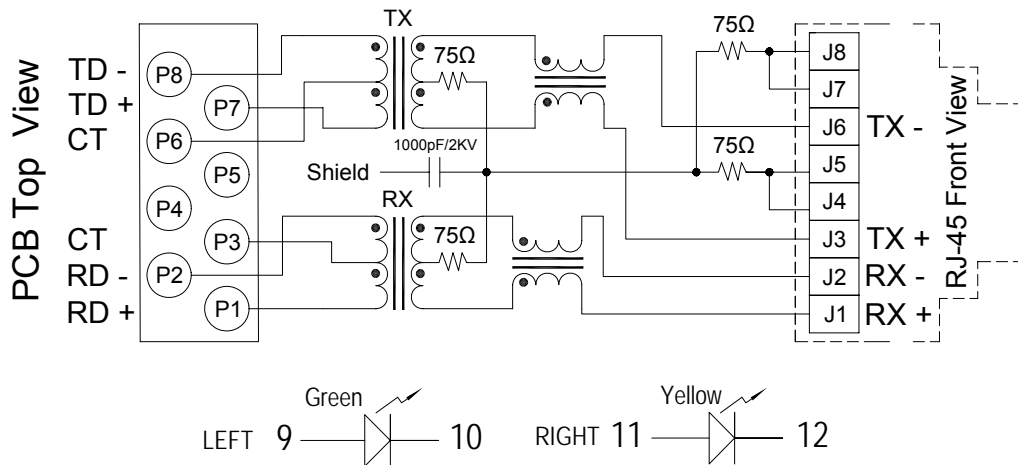

Ref: BOM 表 Y19



| | | | |
|---|--|------|-------------|
|  元册科技股份有限公司 YUAN DEAN SCIENTIFIC CO., LTD. | | | |
| 10/100 Base-T Single Port Rj-45 Jack Magnetics | | | |
| TITLE | 10/100 Base-T Single Port Rj-45 Jack Magnetics | | |
| P/N | 13F-60LDNL | REV. | 0 |
| PAGE NO | 1-2 | DATE | 2008-2-20 |
| AP'PD | Li YueSheng | DWN | Chen JiaPei |

Mechanicals

Housing Material:

MATERIAL:NYLON GF (Fr50) UL94V-0 STANDARD COLOR:BLACK

Insert Material:

MATERIAL:Phos-Bronze C5210 EH---0.35mm Thickness

Insert -PBT GF UL94V-0

- 1.PLATING(1) NICKEL
- 2.PLATING(2) 100%Sn
- 3.PLATING(3) GOLD (3u " ~50u ")

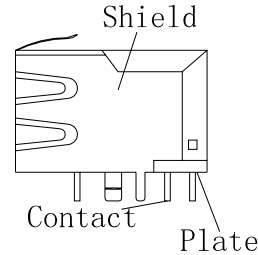
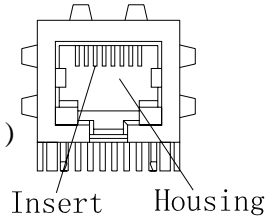

Plate Material:

PBT GF UL 94V-0

Contact pin Material:

MATERIAL: Phos-Bronze C5210 EH---0.35mm Thickness

- 1.PLATING(1) NICKEL
- 2.PLATING(2) 100%Sn

Shielding Material:

BRASS C2680 H.---0.25mm THICKNESS PLATING NICKEL

Operating Life:750 Cycles MIN.

Environmental

- 1.Storage Temp:-40°C TO +85°C.
- 2.Operating Temp: 0°C TO +70°C.
- 3.Wave Soldering Temperature:230~250°C (3~5 SECONDS)
4. MATES WITH MODULAR PLUG CONFORMING TO FCC PART 68,SUBPART F.

Part Number

13F-60LDNL

RoHS version



| REV. | DESCRIPTION | DATE | DWN | AP'PD |
|------|-------------|------|-----|-------|
| | | | | |
| | | | | |

Packaging

1. packaging unit : 60 PCS/tray
2. packaging material : PVC

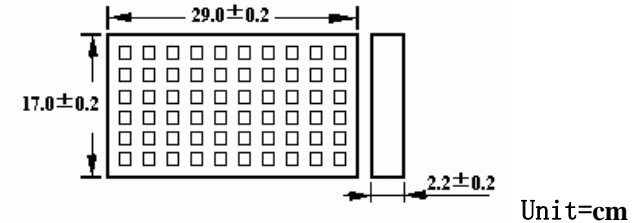

3. outer carton unit: 1320 pcs/ 22 Trays/box

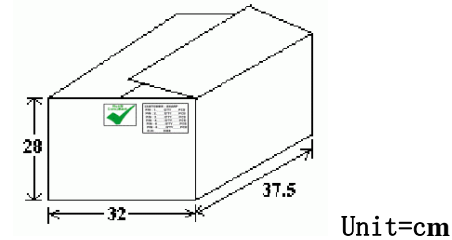

| | | | |
|---|-------------|---|-------------|
|  元册科技股份有限公司 YUAN DEAN SCIENTIFIC CO., LTD. | | TITLE | |
| | | 10/100 Base-T Single Port Rj-45 Jack Magnetics | |
| P/N | 13F-60LDNL | REV. | 0 |
| PAGE NO | 2-2 | DATE | 2008-2-20 |
| AP'PD | Li YueSheng | DWN | Chen JiaPei |