

NCE P-Channel Enhancement Mode Power MOSFET

**Description**

The 1481 uses advanced trench technology to provide excellent  $R_{DS(ON)}$ , low gate charge and operation with gate voltages. This device is suitable for use as a load switching application and a wide variety of other applications.

**General Features**

- $V_{DS} = -12V, I_D = -5.5A$   
 $R_{DS(ON)} < 38m\Omega @ V_{GS} = -2.5V$   
 $R_{DS(ON)} < 26m\Omega @ V_{GS} = -4.5V$
- Advanced trench MOSFET process technology
- Ultra low on-resistance with low gate charge

**Application**

- PWM applications
- Load switch
- Battery charge in cellular handset

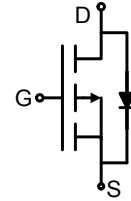

Schematic diagram

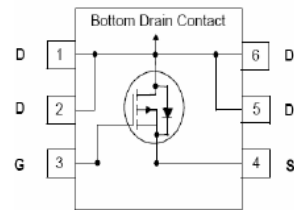

Pin assignment

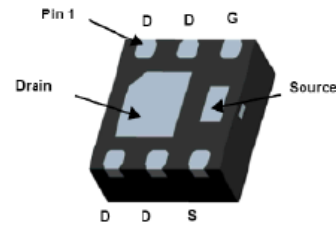

DFN2X2-6L bottom view

**Package marking and ordering information**

Device Marking	Device	Device Package	Reel Size	Tape Width	Quantity
1481	1481	DFN2X2-6L	-	-	-

**Absolute maximum ratings (TA=25°C unless otherwise noted)**

Parameter	Symbol	Limit	Unit
Drain-Source Voltage	$V_{DS}$	-12	V
Gate-Source Voltage	$V_{GS}$	$\pm 8$	V
Drain Current-Continuous	$I_D$	-5.5	A
Drain Current -Pulsed (Note 1)	$I_{DM}$	-65	A
Maximum Power Dissipation	$P_D$	2.5	W
Operating Junction and Storage Temperature Range	$T_J, T_{STG}$	-55 To 150	°C

**Thermal Characteristic**

Thermal Resistance, Junction-to-Ambient (Note 2)	$R_{\theta JA}$	50	°C/W
Thermal Resistance, Junction-to-Case (Note 2)	$R_{\theta JC}$	6.9	°C/W

**Electrical characteristics (TA=25°C unless otherwise noted)**



Parameter	Symbol	Condition	Min	Typ	Max	Unit
<b>Off Characteristics</b>						
Drain-Source Breakdown Voltage	$V_{(BR)DSS}$	$V_{GS}=0V, I_D=-250\mu A$	-12	-	-	V
Zero Gate Voltage Drain Current	$I_{DSS}$	$V_{DS}=-12V, V_{GS}=0V$	-	-	-1	$\mu A$
Gate-Body Leakage Current	$I_{GSS}$	$V_{GS}=\pm 8V, V_{DS}=0V$	-	-	$\pm 100$	nA
<b>On Characteristics (Note 3)</b>						
Gate Threshold Voltage	$V_{GS(th)}$	$V_{DS}=V_{GS}, I_D=-250\mu A$	-0.4	-0.7	-1	V
Drain-Source On-State Resistance	$R_{DS(on)}$	$V_{GS}=-4.5V, I_D=-5.5A$	-	22	26	m $\Omega$
		$V_{GS}=-2.5V, I_D=-4.0A$	-	30	38	m $\Omega$
Forward Transconductance	$g_{FS}$	$V_{DS}=-10V, I_D=-5.5A$	-	23	-	S
<b>Dynamic Characteristics (Note4)</b>						
Input Capacitance	$C_{iss}$	$V_{DS}=-10V, V_{GS}=0V,$ $F=1.0MHz$	-	2700	-	PF
Output Capacitance	$C_{oss}$		-	680	-	PF
Reverse Transfer Capacitance	$C_{rss}$		-	590	-	PF
<b>Switching Characteristics (Note 4)</b>						
Turn-on Delay Time	$t_{d(on)}$	$V_{DD}=-10V, I_D=-1A$ $V_{GS}=-4.5V, R_{GEN}=10\Omega$	-	11	-	nS
Turn-on Rise Time	$t_r$		-	35	-	nS
Turn-Off Delay Time	$t_{d(off)}$		-	30	-	nS
Turn-Off Fall Time	$t_f$		-	10	-	nS
Total Gate Charge	$Q_g$	$V_{DS}=-6V, I_D=-10A,$ $V_{GS}=-4.5V$	-	35	48	nC
Gate-Source Charge	$Q_{gs}$		-	5	-	nC
Gate-Drain Charge	$Q_{gd}$		-	10	-	nC
<b>Drain-Source Diode Characteristics</b>						
Diode Forward Voltage (Note 3)	$V_{SD}$	$V_{GS}=0V, I_S=-8A$	-	-	-1.2	V
Diode Forward Current (Note 2)	$I_S$		-	-	-16	A

**Notes:**

1. Repetitive Rating: Pulse width limited by maximum junction temperature.
2. Surface Mounted on FR4 Board,  $t \leq 10$  sec.
3. Pulse Test: Pulse Width  $\leq 300\mu s$ , Duty Cycle  $\leq 2\%$ .
4. Guaranteed by design, not subject to production

TYPICAL ELECTRICAL AND THERMAL CHARACTERISTICS

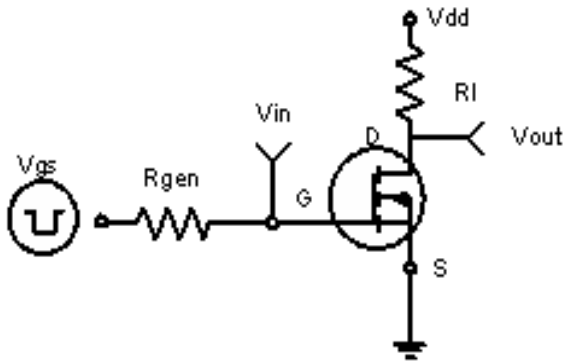

Figure 1: Switching Test Circuit

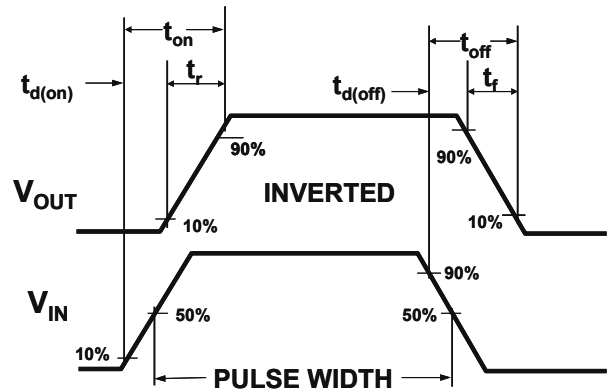

Figure 2: Switching Waveforms

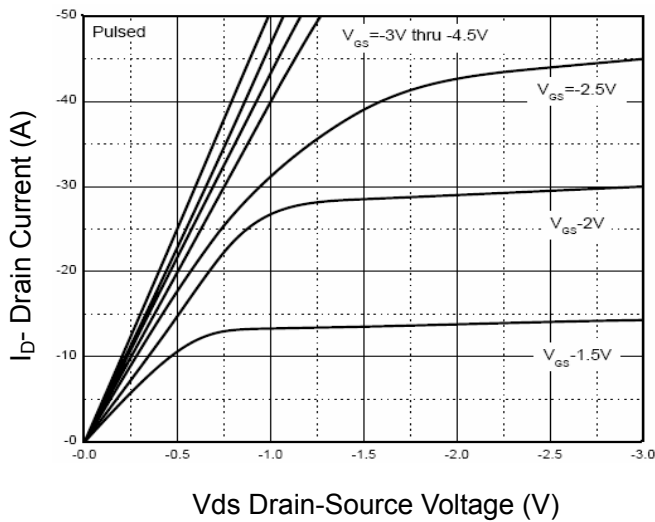

Figure 3 Output Characteristics

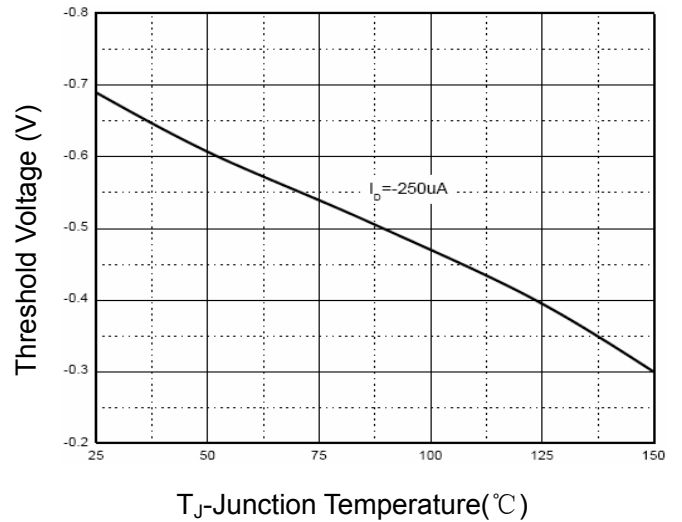

Figure 4 Drain Current

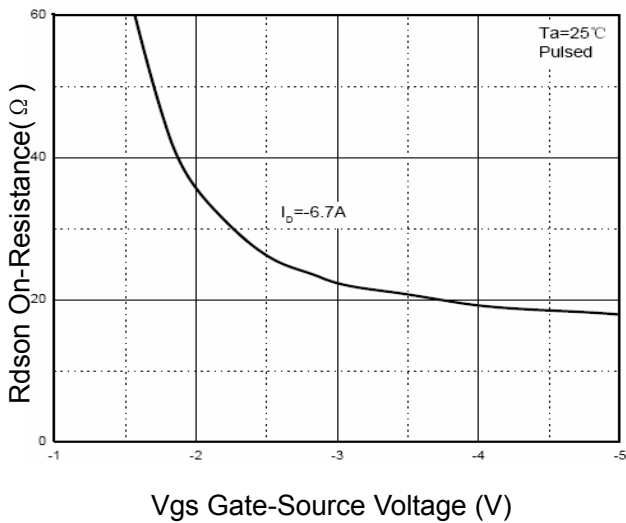

Figure 5 Rdson vs Vgs

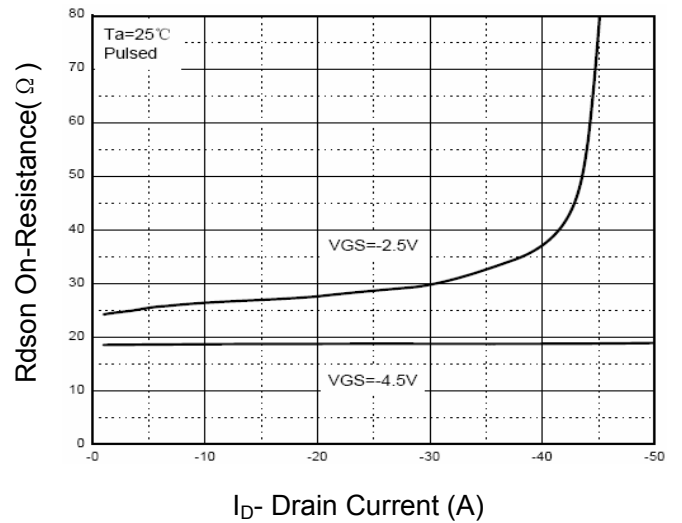
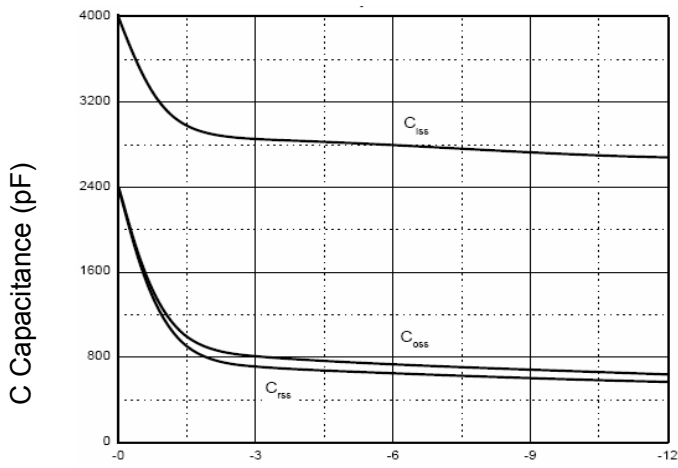
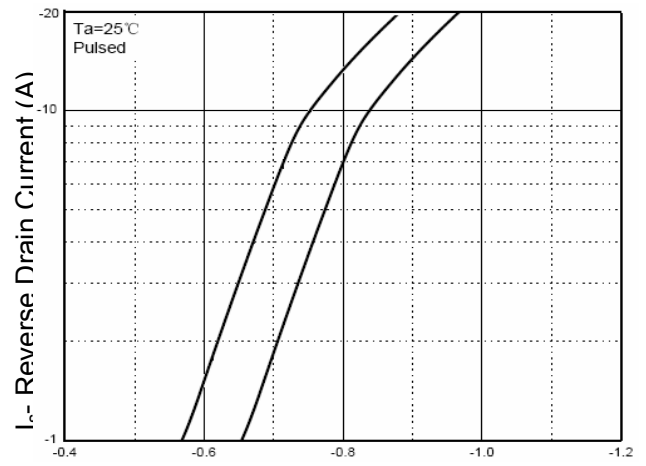

Figure 6 Drain-Source On-Resistance



Vds Drain-Source Voltage (V)  
**Figure 7 Capacitance vs Vds**



Vsd Source-Drain Voltage (V)  
**Figure 8 Source- Drain Diode Forward**

DFN2X2-6L Package Information

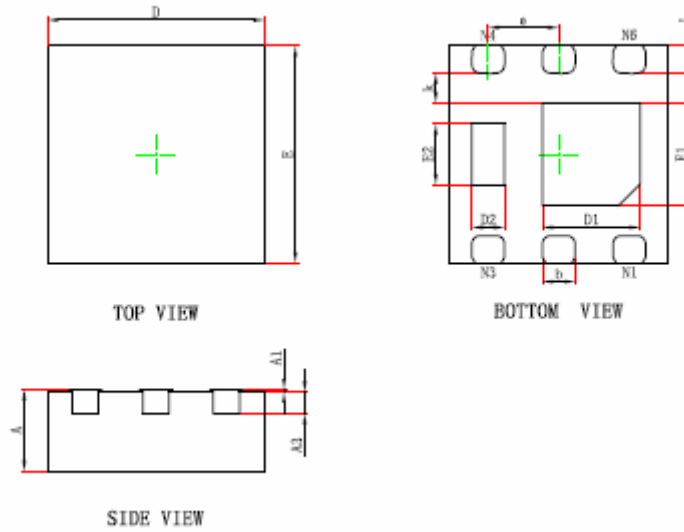

Symbol	Dimensions In Millimeters		Dimensions In Inches	
	Min.	Max.	Min.	Max.
A	0.700	0.800	0.028	0.031
A1	0.000	0.050	0.000	0.002
A3	0.203REF.		0.008REF.	
D	1.924	2.076	0.076	0.082
E	1.924	2.076	0.076	0.082
D1	0.800	1.000	0.031	0.039
E1	0.850	1.050	0.033	0.041
D2	0.200	0.400	0.008	0.016
E2	0.460	0.660	0.018	0.026
k	0.200MIN.		0.008MIN.	
b	0.250	0.350	0.010	0.014
e	0.650TYP.		0.026TYP.	
L	0.174	0.326	0.007	0.013

Notes

1. All dimensions are in millimeters.
2. Tolerance  $\pm 0.10\text{mm}$  (4 mil) unless otherwise specified
3. Package body sizes exclude mold flash and gate burrs. Mold flash at the non-lead sides should be less than 5 mils.
4. Dimension L is measured in gauge plane.
5. Controlling dimension is millimeter, converted inch dimensions are not necessarily exact.