



Technical Data Sheet

Full Color Chip LEDs

15-23B/R6G6BHC-A01/2T

Features

- Package in 8mm tape on 7" diameter reel.
- Compatible with automatic placement equipment.
- Compatible with infrared and vapor phase reflow solder process.
- Full-color type.



Descriptions

- The 15-23B SMD Taping is much smaller than lead frame type components, thus enable smaller board size, higher packing density, reduced storage space and finally smaller equipment to be obtained.
- Besides, lightweight makes them ideal for miniature applications. etc.

Applications

- Automotive: backlighting in dashboard and switch.
- Telecommunication: indicator and backlighting in telephone and fax.
- Flat backlight for LCD, switch and symbol.
- General use.

Device Selection Guide

Chip			Lens Color
Type	Material	Emitted Color	
R6	AlGaInP	Brilliant Red	Water Clear
G6	InGaN	Brilliant Yellow Green	
BH	InGaN	Blue	

15-23B/R6G6BHC-A01/2T

Package Outline Dimensions

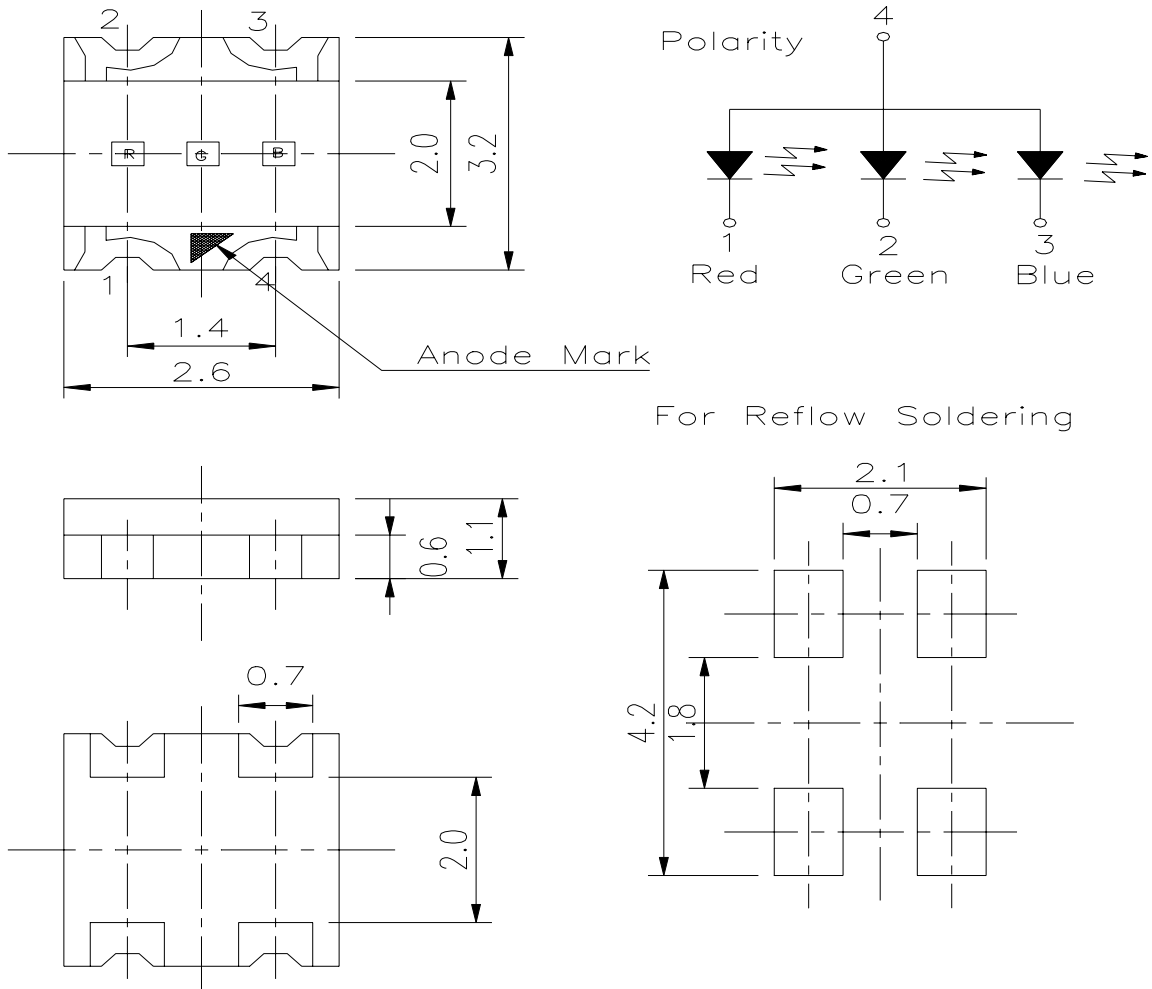

Notes: Tolerances Unless Dimension $\pm 0.1\text{mm}$, Unit = mm

15-23B/R6G6BHC-A01/2T**Absolute Maximum Ratings (Ta=25°C)**

Parameter Sym	bol	Rating	Unit
Reverse Voltage	V _R 5		V
Forward Current	I _F	R6:25 G6:25 BH:25	mA
Operating Temperature	T _{opr}	-40 ~ +85	°C
Storage Temperature	T _{stg}	-40 ~ +90	°C
Soldering Temperature	T _{sol}	260 (for 5 seconds)	°C
Electrostatic Discharge	ESD	R6:2000 G6:150 BH:150	V
Power Dissipation	P _d	R6:60 G6:110 BH:110	mW
Peak Forward Current (Duty 1/10 @1KHz)	I _{F P}	R6:60 G6:100 BH:100	mA

15-23B/R6G6BHC-A01/2T
Electro-Optical Characteristics (Ta=25°C)

Parameter	Symbol	Min.	Typ.	Max.	Unit	Condition
Luminous Intensity	R6	72	100	180	mcd	If=20mA
	Iv G 6	28.5	50	90		
	B H	28.5	50	90		
Viewing Angle	2θ 1/2	-----	120	-----	deg	
Peak Wavelength	R6		632		nm	
	λp G 6	-----	575	-----		
	B H		468			
Dominant Wavelength	R6	619		629	nm	
	λd G 6	568	-----	575		
	B H	465		480		
Spectrum Radiation Bandwidth	R6		20		nm	
	Δλ G 6	-----	20	-----		
	B H		25			
Forward Voltage	R6		2.0	2.4	V	
	Vf G 6	-----	2.0	2.4		
	B H		3.5	3.9		
Reverse Current	R6			10	μA	VR=5V
	IR G 6	-----		10		
	B H			50		

Notes:

- 1.Tolerance of Luminous Intensity ±10%
- 2.Tolerance of Dominant Wavelength ±1nm
- 3.Tolerance of Forward Voltage ±0.1V

15-23B/R6G6BHC-A01/2T

Typical Electro-Optical Characteristics Curves

R6

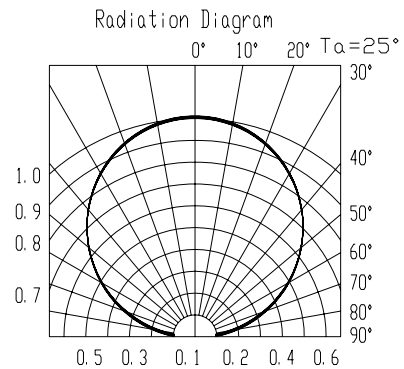
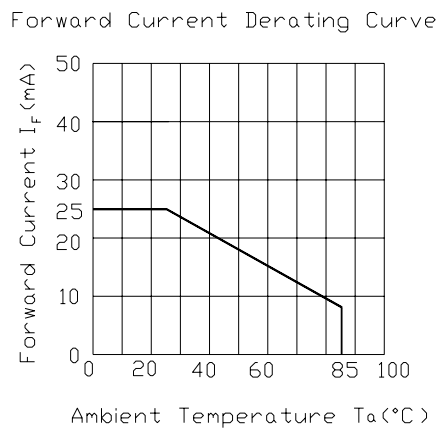
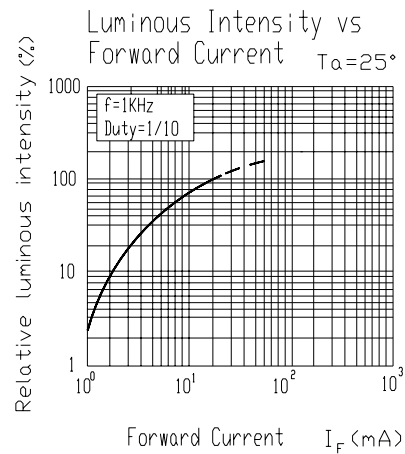
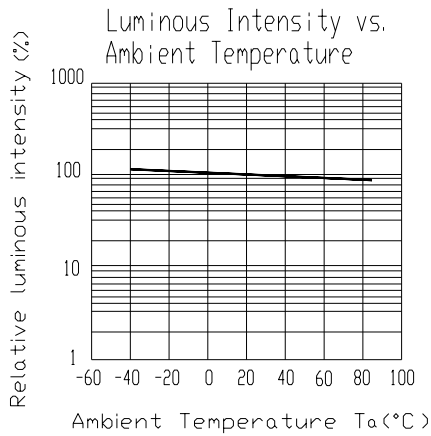
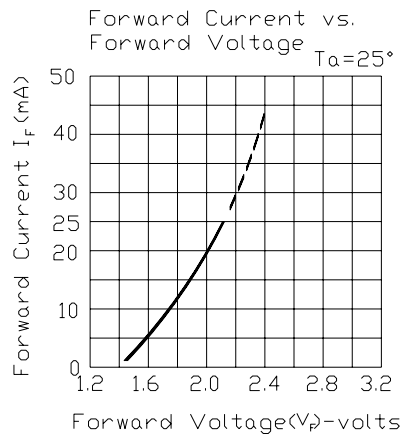
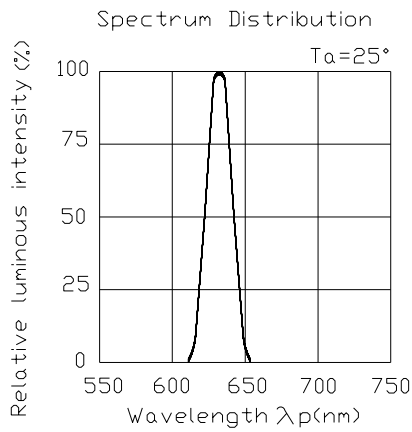

15-23B/R6G6BHC-A01/2T

Typical Electro-Optical Characteristics Curves

G6

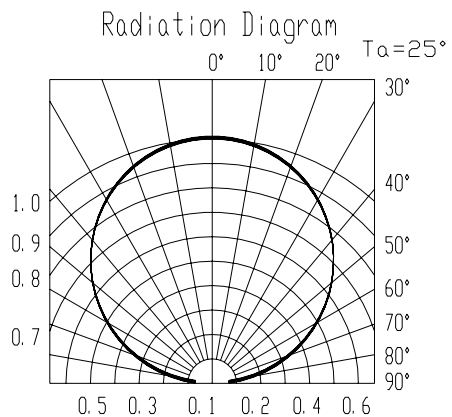
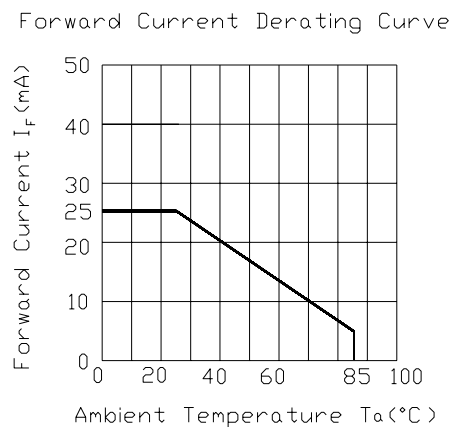
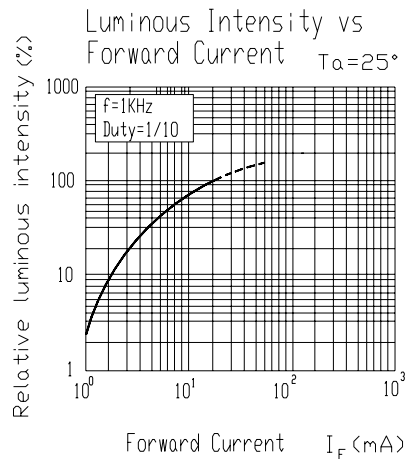
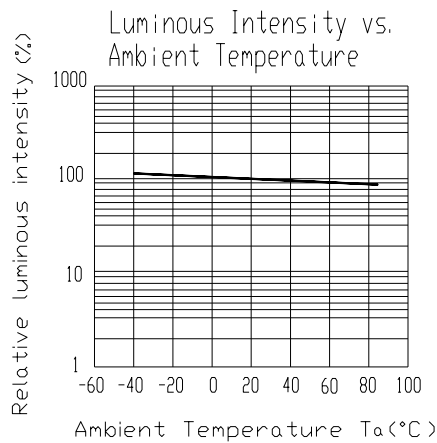
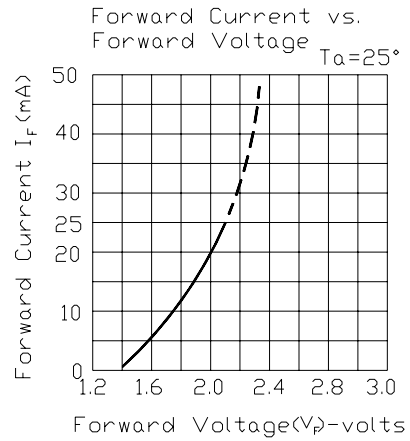
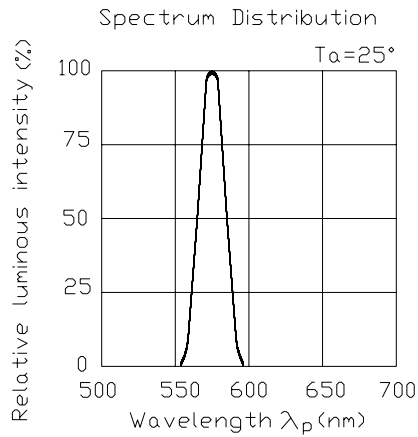

15-23B/R6G6BHC-A01/2T

Typical Electro-Optical Characteristics Curves

BH

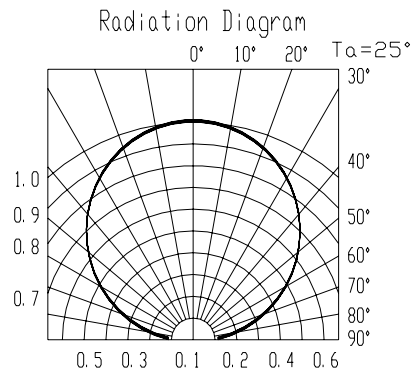
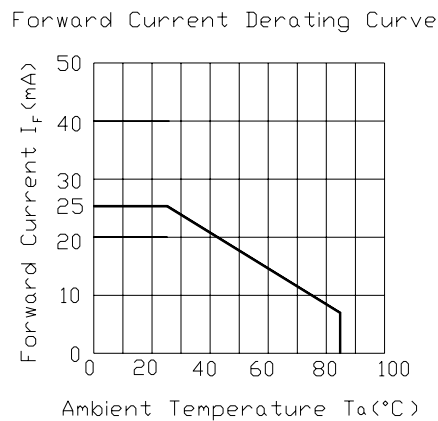
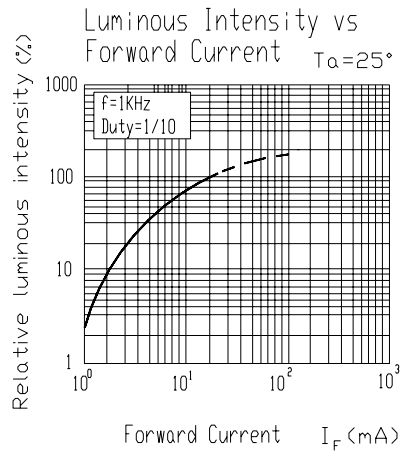
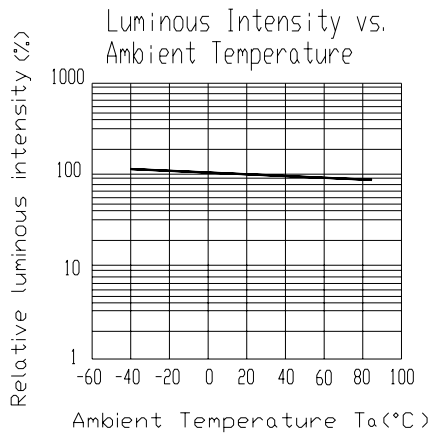
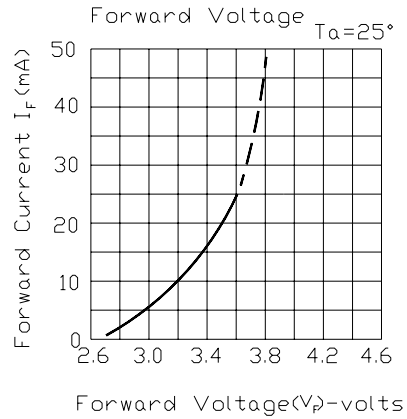
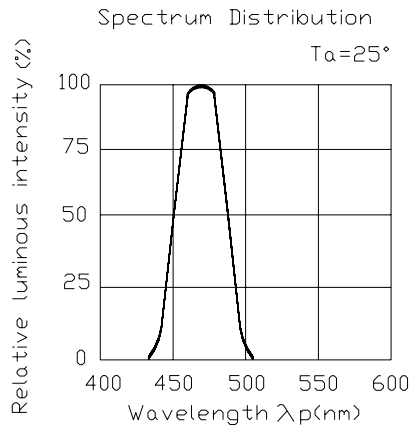

15-23B/R6G6BHC-A01/2T

Label explanation

CAT: Luminous Intensity Rank

HUE: Dom. Wavelength Rank

REF: Forward Voltage Rank



Reel Dimensions

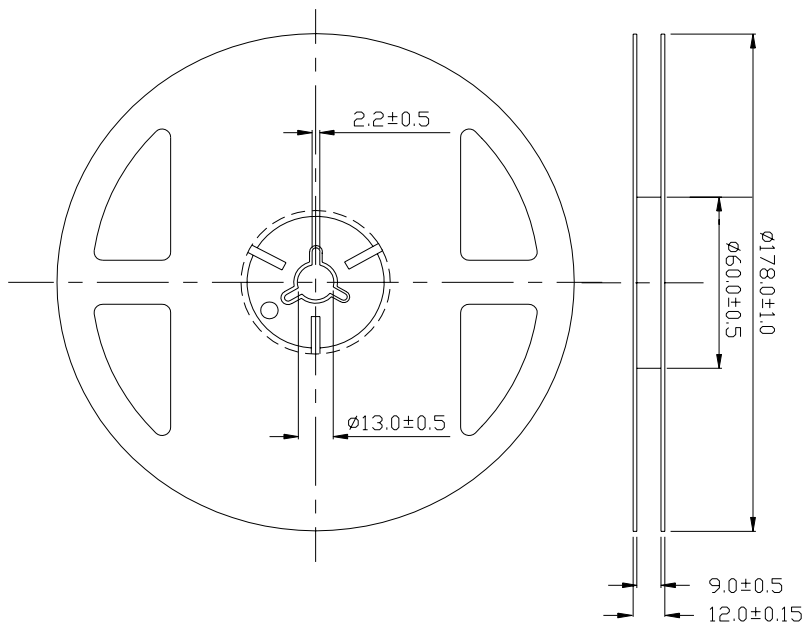

Note: The tolerances unless mentioned is ± 0.1 mm ,Unit = mm

15-23B/R6G6BHC-A01/2T

Carrier Tape Dimensions: Loaded quantity 2000 PCS per reel

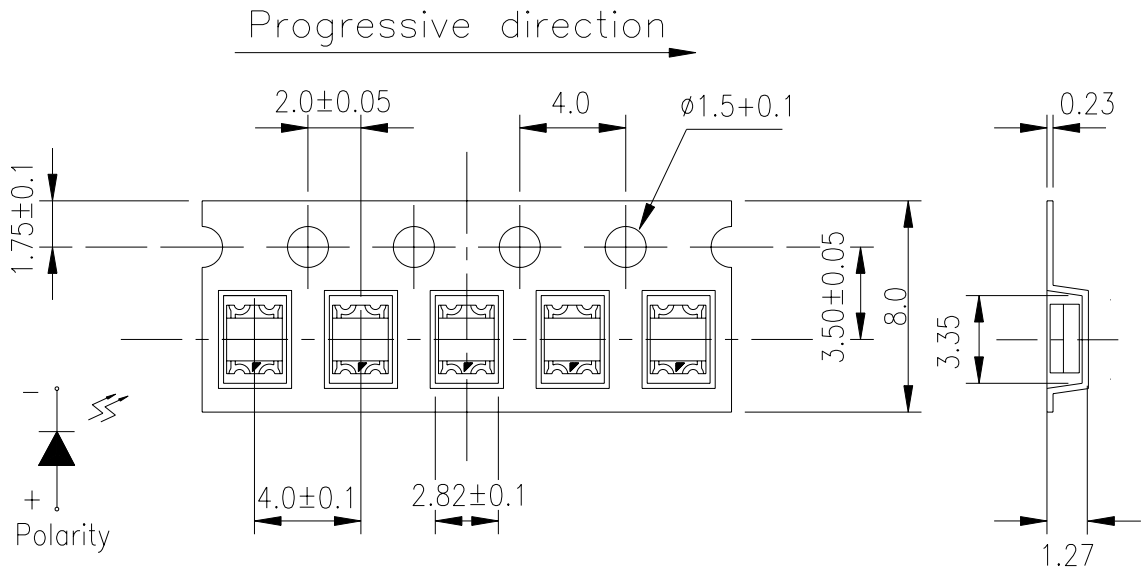

Note: The tolerances unless mentioned is $\pm 0.1\text{mm}$,Unit = mm

Moisture Resistant Packaging

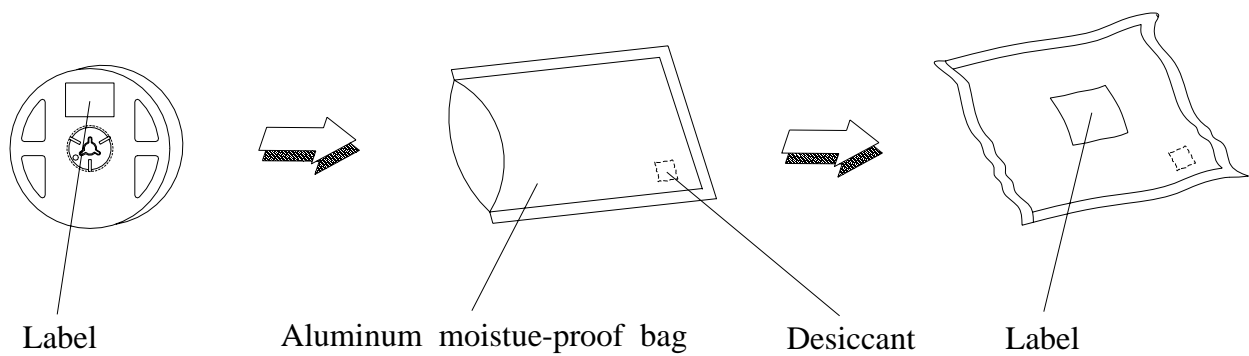

15-23B/R6G6BHC-A01/2T
Reliability Test Items And Conditions

The reliability of products shall be satisfied with items listed below.

Confidence level : 90%

LTPD : 10%

No.	Item	Test Condition	Test Hours/Cycles	Sample Size	Ac/Re
1	Reflow Soldering	Temp. : 240°C ±5°C 5sec.	6 Min.	22 PCS.	0/1
2	Temperature Cycle	H : +100°C 15m in ∫ 5 min L : -40°C 15m in	300 Cycles	22 PCS.	0/1
3	Thermal Shock	H : +100°C 5m in ∫ 10 sec L : -10°C 5m in	300 Cycles	22 PCS.	0/1
4	High Temperature Storage	Temp. : 100°C	1000 Hrs.	22 PCS.	0/1
5	Low Temperature Storage	Temp. : -40°C	1000 Hrs.	22 PCS.	0/1
6	DC Operating Life	I _F = 20 mA	1000 Hrs.	22 PCS.	0/1
7	High Temperature / High Humidity	85°C/R.H85%	1000 Hrs.	22 PCS.	0/1

15-23B/R6G6BHC-A01/2T**Precautions For Use****1. Over-current-proof**

Customer must apply resistors for protection , otherwise slight voltage shift will cause big current change (Burn out will happen).

2. Storage

2.1 Do not open moisture proof bag before the products are ready to use.

2.2 Before opening the package, the LEDs should be kept at 30°C or less and 90%RH or less.

2.3 The LEDs should be used within a year.

2.4 After opening the package, the LEDs should be kept at 30°C or less and 70%RH or less.

2.5 The LEDs should be used within 168 hours (7 days) after opening the package.

2.6 If the moisture absorbent material (silica gel) has faded away or the LEDs have exceeded the storage time, baking treatment should be performed using the following conditions.

Baking treatment : 60±5°C for 24 hours.

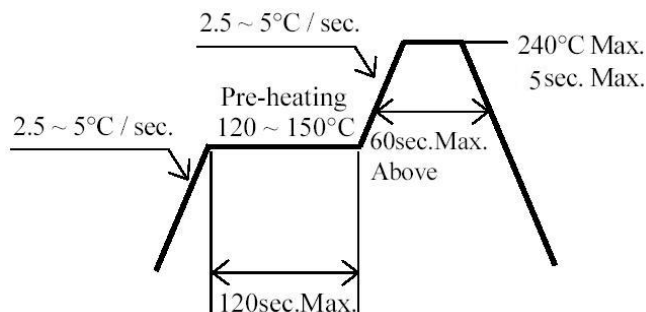
3. Soldering Condition**3.1 Lead solder temperature profile**

3.2 Reflow soldering should not be done more than two times.

3.3 When soldering, do not put stress on the LEDs during heating.

3.4 After soldering, do not warp the circuit board.

4. Soldering Iron

Each terminal is to go to the tip of soldering iron temperature less than 280°C for 3 seconds within once in less than the soldering iron capacity 25W. Leave two seconds and more intervals, and do soldering of each terminal. Be careful because the damage of the product is often started at the time of the hand solder.

15-23B/R6G6BHC-A01/2T**5.Repairing**

Repair should not be done after the LEDs have been soldered. When repairing is unavoidable, a double-head soldering iron should be used (as below figure). It should be confirmed beforehand whether the characteristics of the LEDs will or will not be damaged by repairing.

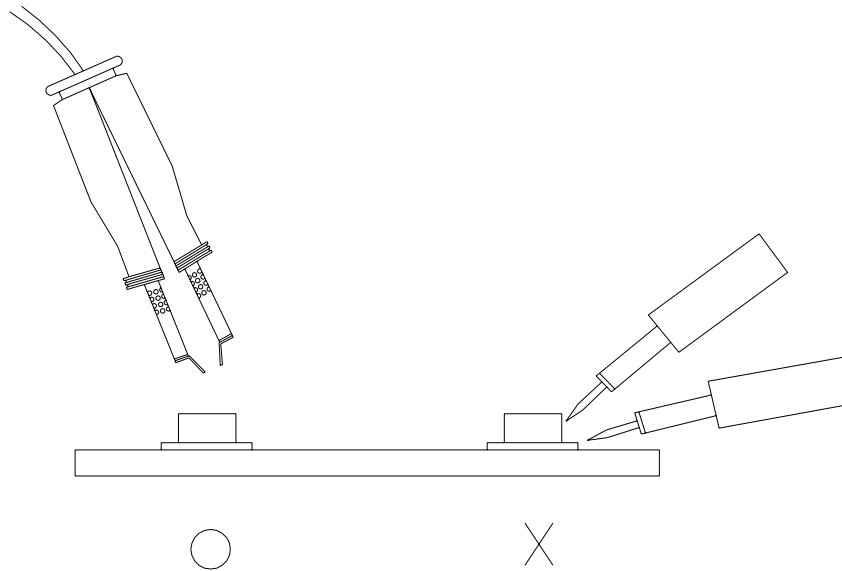

EVERLIGHT ELECTRONICS CO., LTD. Tel

: 886-2-2267-2000, 2267-9936

Office: No 25, Lane 76, Sec 3, Chung Yang Rd,

Fax: 886-2267-6244, 2267-6189, 2267-6306

Tucheng, Taipei 236, Taiwan, R.O.C <http://www.everlight.com>