

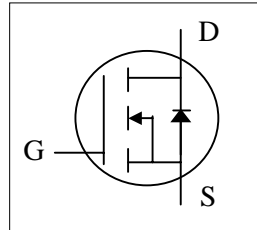

- ▼ Low Gate Charge
- ▼ Simple Drive Requirement
- ▼ Fast Switching



BV_{DSS}	30V
$R_{DS(ON)}$	80m Ω
I_D	15A

Description

The TO-252 package is universally preferred for all commercial-industrial surface mount applications and suited for low voltage applications such as DC/DC converters. The through-hole version (AP15N03GJ) is available for low-profile applications.

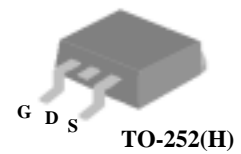

TO-252(H)

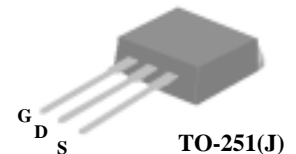

TO-251(J)

Absolute Maximum Ratings

Symbol	Parameter	Rating	Units
V_{DS}	Drain-Source Voltage	30	V
V_{GS}	Gate-Source Voltage	± 20	V
$I_D @ T_C=25^\circ C$	Continuous Drain Current, $V_{GS} @ 10V$	15	A
$I_D @ T_C=100^\circ C$	Continuous Drain Current, $V_{GS} @ 10V$	9	A
I_{DM}	Pulsed Drain Current ¹	50	A
$P_D @ T_C=25^\circ C$	Total Power Dissipation	28	W
	Linear Derating Factor	0.22	W/ $^\circ C$
T_{STG}	Storage Temperature Range	-55 to 150	$^\circ C$
T_J	Operating Junction Temperature Range	-55 to 150	$^\circ C$

Thermal Data

Symbol	Parameter	Value	Unit
$R_{thj-case}$	Thermal Resistance Junction-case	Max. 4.8	$^\circ C/W$
$R_{thj-amb}$	Thermal Resistance Junction-ambient	Max. 110	$^\circ C/W$



AP15N03GH/J

Electrical Characteristics @T_j=25°C (unless otherwise specified)

Symbol	Parameter	Test Conditions	Min.	Typ.	Max.	Units
BV _{DSS}	Drain-Source Breakdown Voltage	V _{GS} =0V, I _D =250uA	30	-	-	V
ΔBV _{DSS} /ΔT _j	Breakdown Voltage Temperature Coefficient	Reference to 25°C, I _D =1mA	-	0.037	-	V/°C
R _{DS(ON)}	Static Drain-Source On-Resistance	V _{GS} =10V, I _D =8A	-	-	80	mΩ
		V _{GS} =4.5V, I _D =6A	-	-	100	mΩ
V _{GS(th)}	Gate Threshold Voltage	V _{DS} =V _{GS} , I _D =250uA	1	-	3	V
g _{fs}	Forward Transconductance	V _{DS} =10V, I _D =18A	-	16	-	S
I _{DSS}	Drain-Source Leakage Current (T _j =25°C)	V _{DS} =30V, V _{GS} =0V	-	-	1	uA
	Drain-Source Leakage Current (T _j =150°C)	V _{DS} =24V, V _{GS} =0V	-	-	25	uA
I _{GSS}	Gate-Source Leakage	V _{GS} = ± 20V	-	-	±100	nA
Q _g	Total Gate Charge ²	I _D =8A	-	4.6	-	nC
Q _{gs}	Gate-Source Charge	V _{DS} =24V	-	1.1	-	nC
Q _{gd}	Gate-Drain ("Miller") Charge	V _{GS} =5V	-	3	-	nC
t _{d(on)}	Turn-on Delay Time ²	V _{DS} =15V	-	4.9	-	ns
t _r	Rise Time	I _D =8A	-	22.5	-	ns
t _{d(off)}	Turn-off Delay Time	R _G =3.4Ω, V _{GS} =10V	-	12.2	-	ns
t _f	Fall Time	R _D =1.9Ω	-	3.3	-	ns
C _{iss}	Input Capacitance	V _{GS} =0V	-	160	-	pF
C _{oss}	Output Capacitance	V _{DS} =25V	-	107	-	pF
C _{riss}	Reverse Transfer Capacitance	f=1.0MHz	-	32	-	pF

Source-Drain Diode

Symbol	Parameter	Test Conditions	Min.	Typ.	Max.	Units
I _S	Continuous Source Current (Body Diode)	V _D =V _G =0V , V _S =1.3V	-	-	15	A
I _{SM}	Pulsed Source Current (Body Diode) ¹		-	-	50	A
V _{SD}	Forward On Voltage ²	T _j =25°C, I _S =15A, V _{GS} =0V	-	-	1.3	V

Notes:

1. Pulse width limited by safe operating area.
2. Pulse width ≤300us , duty cycle ≤2%.

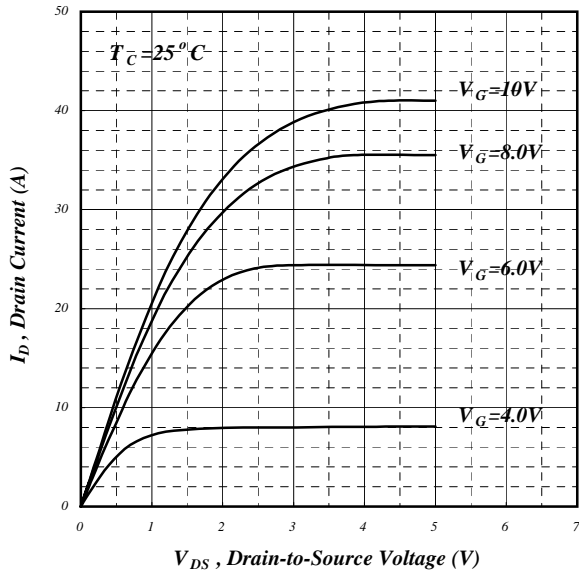

Fig 1. Typical Output Characteristics

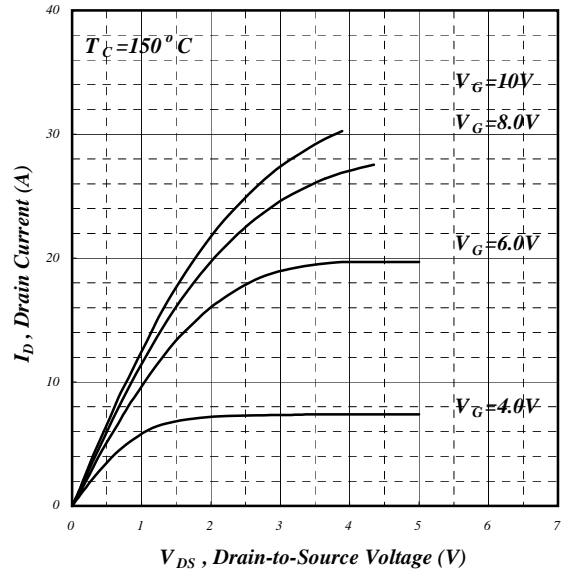

Fig 2. Typical Output Characteristics

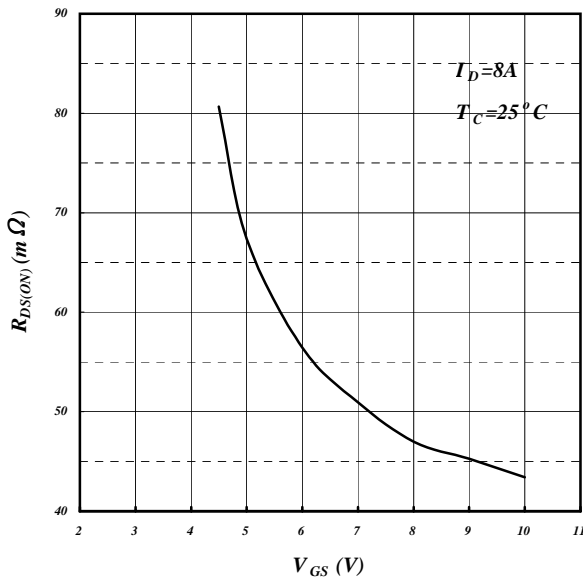

Fig 3. On-Resistance v.s. Gate Voltage

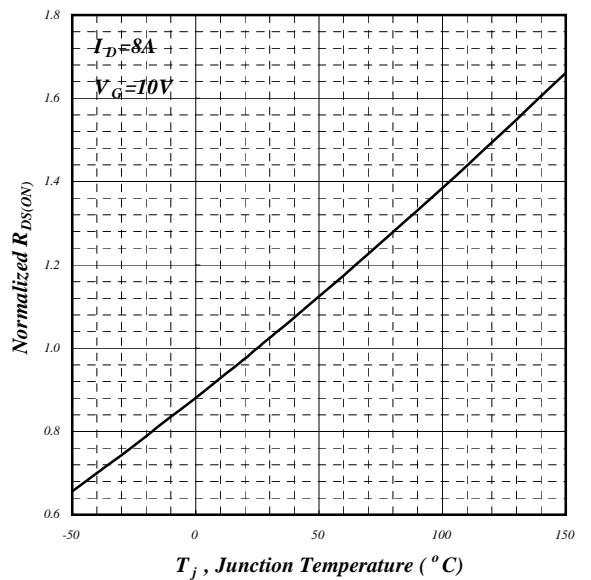

Fig 4. Normalized On-Resistance v.s. Junction Temperature

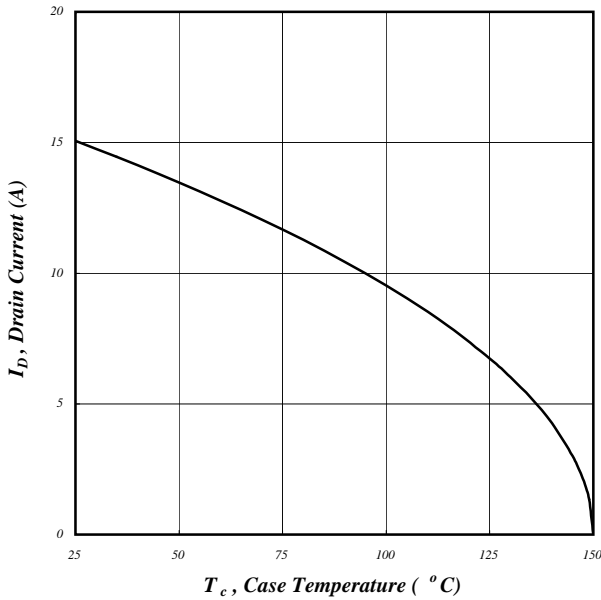

Fig 5. Maximum Drain Current v.s. Case Temperature

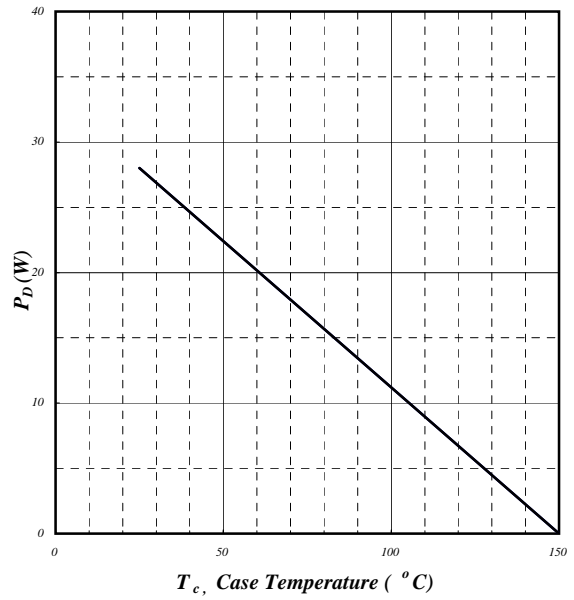

Fig 6. Typical Power Dissipation

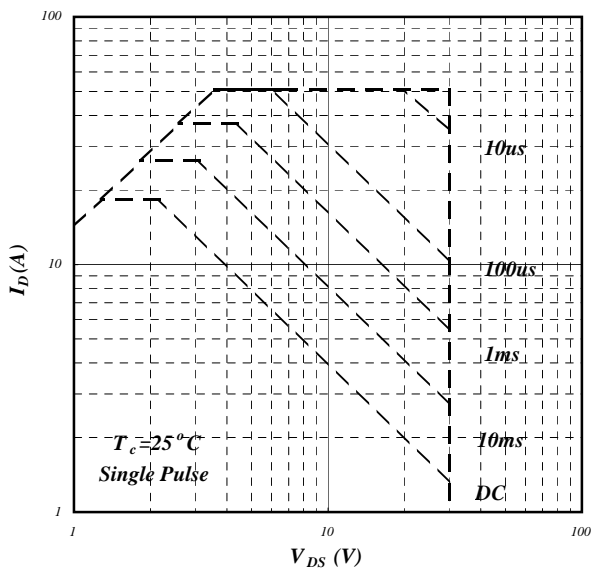

Fig 7. Maximum Safe Operating Area

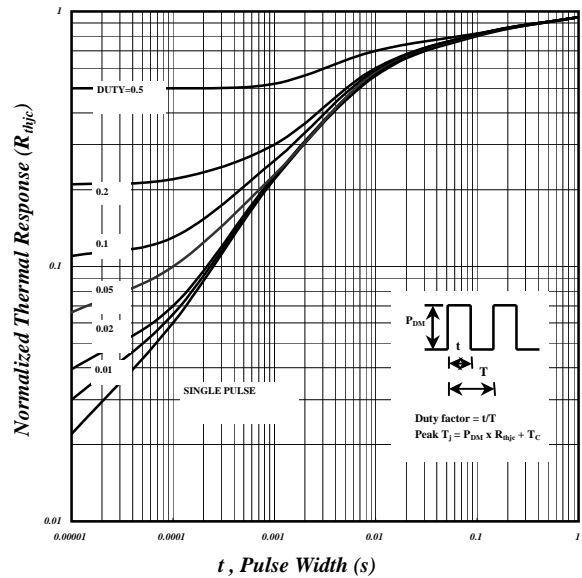

Fig 8. Effective Transient Thermal Impedance

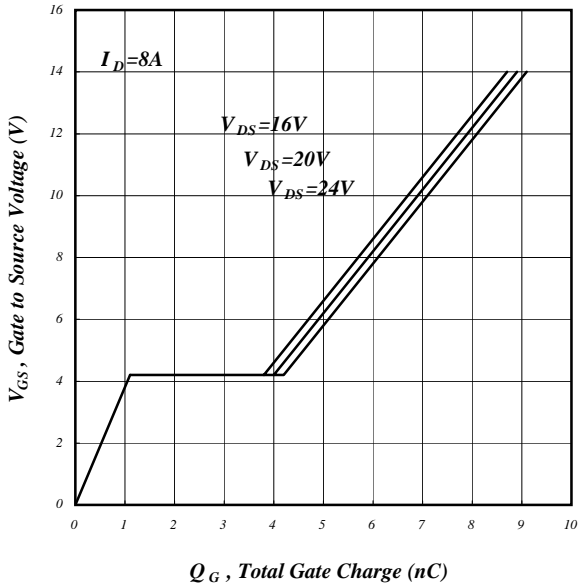

Fig 9. Gate Charge Characteristics

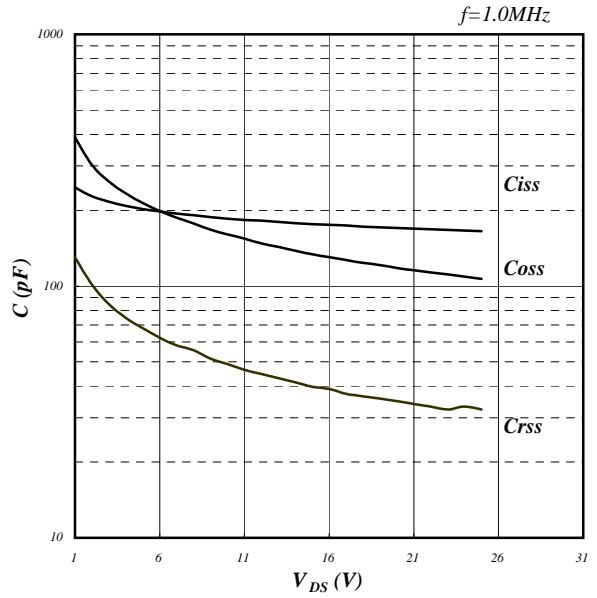

Fig 10. Typical Capacitance Characteristics

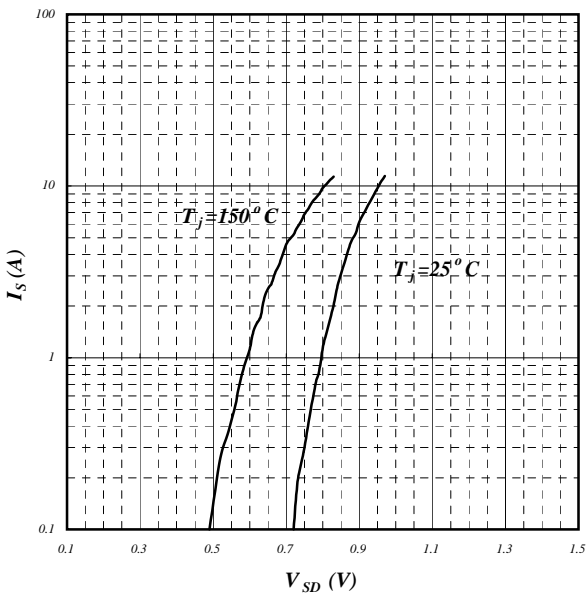

Fig 11. Forward Characteristic of Reverse Diode

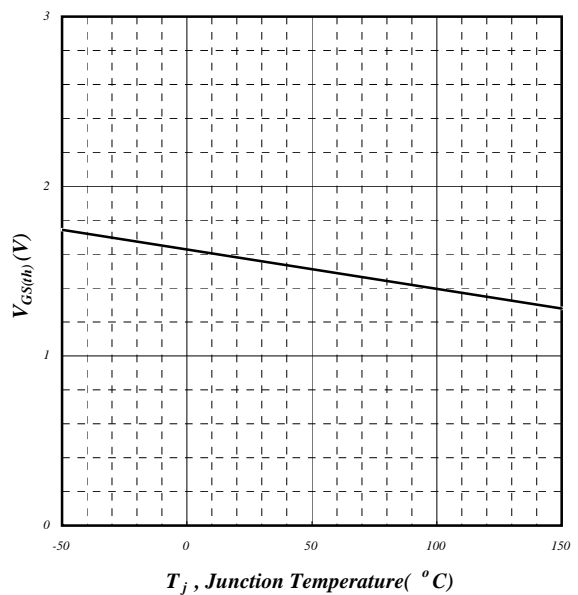

Fig 12. Gate Threshold Voltage v.s. Junction Temperature

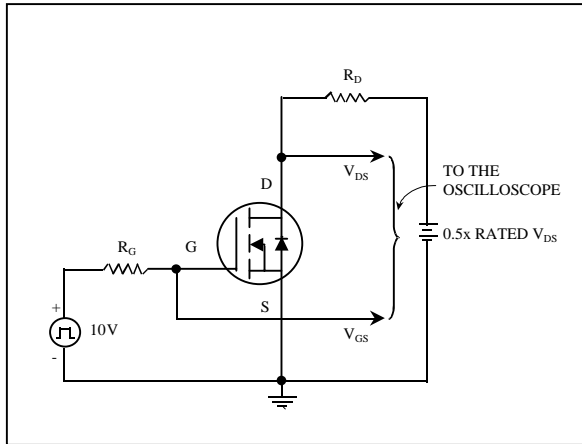

Fig 13. Switching Time Circuit

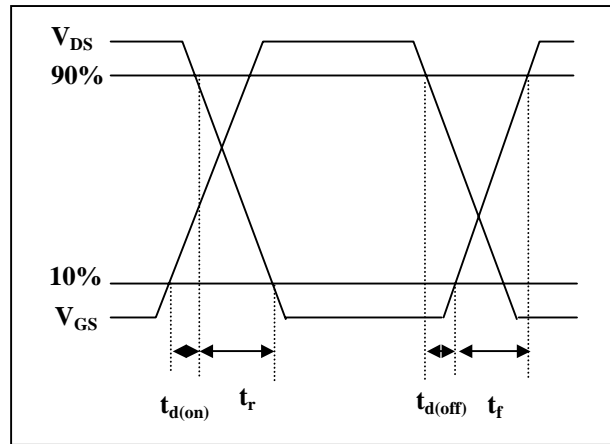

Fig 14. Switching Time Waveform

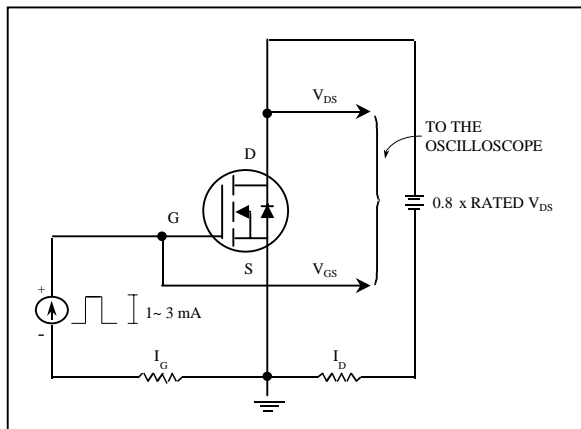

Fig 15. Gate Charge Circuit

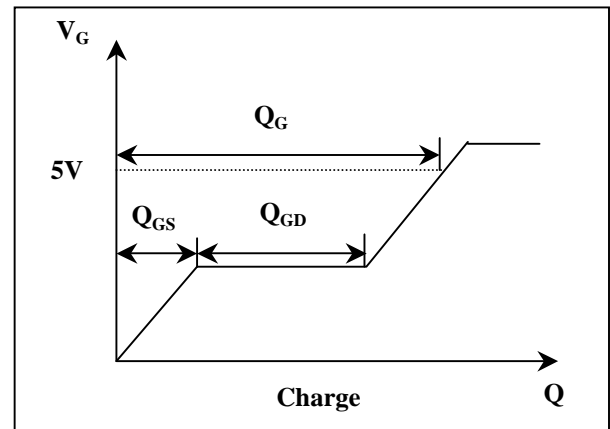

Fig 16. Gate Charge Waveform