

RoHS Compliant Product  
A suffix of "-C" specifies halogen free

## DESCRIPTION

The SSD15N10 provide the designer with the best combination of fast switching. The TO-252 package is universally preferred for all commercial-industrial surface mount applications. The device is suited for charger, industrial and consumer environment.

## FEATURES

- $R_{DS(on)} \leq 100m\Omega @ V_{GS} = 10V$
- Super high density cell design for extremely low  $R_{DS(on)}$
- Exceptional on-resistance and maximum DC current capability

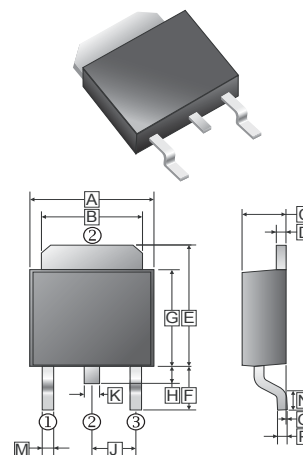
## MARKING



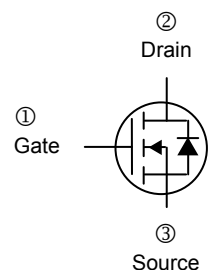
## PACKAGE INFORMATION

Package	MPQ	Leader Size
TO-252	2.5K	13' inch

## TO-252(D-Pack)



REF.	Millimeter		REF.	Millimeter	
	Min.	Max.		Min.	Max.
A	6.4	6.8	J	2.30	REF.
B	5.20	5.50	K	0.70	0.90
C	2.20	2.40	M	0.50	1.1
D	0.45	0.58	N	0.9	1.6
E	6.8	7.3	O	0	0.15
F	2.40	3.0	P	0.43	0.58
G	5.40	6.2			
H	0.8	1.20			



## ABSOLUTE MAXIMUM RATINGS ( $T_A = 25^\circ C$ unless otherwise specified)

Parameter	Symbol	Ratings	Unit
Drain-Source Voltage	$V_{DS}$	100	V
Gate-Source Voltage	$V_{GS}$	$\pm 20$	V
Continuous Drain Current	$I_D$	$T_C = 25^\circ C$	15
		$T_C = 70^\circ C$	13.8
Pulsed Drain Current <sup>1</sup>	$I_{DM}$	24	A
Power Dissipation	$P_D$	$T_C = 25^\circ C$	44.6
		$T_A = 25^\circ C$	2
Operating Junction and Storage Temperature Range	$T_J, T_{STG}$	-55 ~ 150	$^\circ C$
<b>Thermal Resistance Ratings</b>			
Maximum Thermal Resistance Junction-Ambient (PCB mount) <sup>3</sup>	$R_{\theta JA}$	62.5	$^\circ C / W$
Maximum Thermal Resistance Junction-Case	$R_{\theta JC}$	2.8	$^\circ C / W$

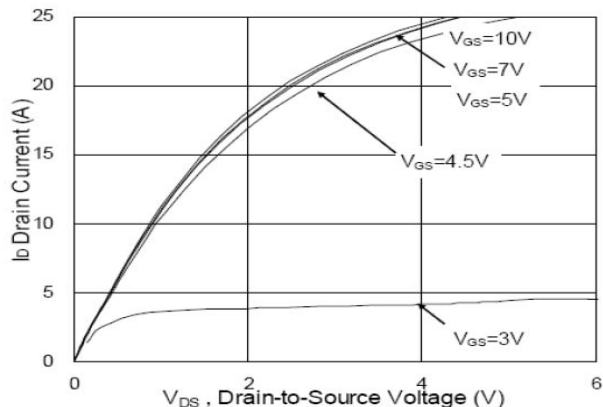
**ELECTRICAL CHARACTERISTICS** ( $T_A = 25^\circ\text{C}$  unless otherwise specified)

Parameter	Symbol	Min.	Typ.	Max.	Unit	Test conditions
Drain-Source Breakdown Voltage	$BV_{DSS}$	100	-	-	V	$V_{GS}=0, I_D=250\mu\text{A}$
Gate Threshold Voltage	$V_{GS(th)}$	1.0	-	2.5	V	$V_{DS}=V_{GS}, I_D=250\mu\text{A}$
Gate-Source Leakage Current	$I_{GSS}$	-	-	$\pm 100$	nA	$V_{GS} = \pm 20\text{V}$
Drain-Source Leakage Current	$I_{DSS}$	-	-	1	$\mu\text{A}$	$V_{DS}=80\text{V}, V_{GS}=0$
Static Drain-Source On-Resistance <sup>2</sup>	$R_{DS(ON)}$	-	100	110	m $\Omega$	$V_{GS}=10\text{V}, I_D=8\text{A}$
Total Gate Charge <sup>2</sup>	$Q_g$	-	26.2	-	nC	$I_D=10\text{A}$ $V_{DS}=80\text{V}$ $V_{GS}=10\text{V}$
Gate-Source Charge	$Q_{gs}$	-	4.6	-		
Gate-Drain ("Miller") Change	$Q_{gd}$	-	5.1	-		
Turn-on Delay Time <sup>2</sup>	$T_{d(on)}$	-	4.2	-	nS	$V_{DS}=50\text{V}$ $I_D=10\text{A}$ $V_{GS}=10\text{V}$ $R_L=5\Omega$ $R_G=3.3\Omega$
Rise Time	$T_r$	-	8.2	-		
Turn-off Delay Time	$T_{d(off)}$	-	35.6	-		
Fall Time	$T_f$	-	9.6	-		
Input Capacitance	$C_{iss}$	-	1535	-	pF	$V_{GS}=0$ $V_{DS}=15\text{V}$ $f=1.0\text{MHz}$
Output Capacitance	$C_{oss}$	-	60	-		
Reverse Transfer Capacitance	$C_{rss}$	-	37	-		
Gate Resistance	$R_g$	-	2	-	$\Omega$	$f=1.0\text{MHz}$
<b>Source-Drain Diode</b>						
Forward On Voltage <sup>2</sup>	$V_{SD}$	-	-	1.2	V	$I_S=8.0\text{A}, V_{GS}=0\text{V}$

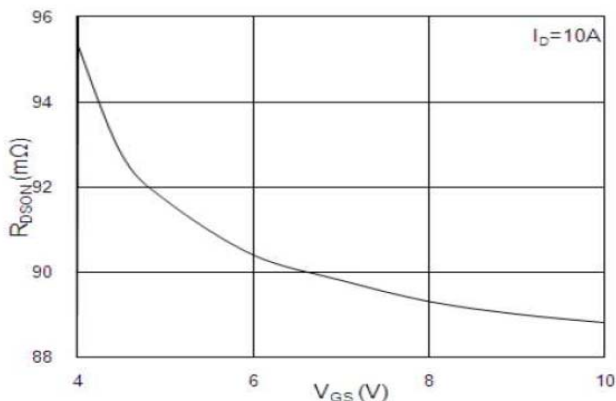
Notes:

1. Pulse width limited by maximum junction temperature.
2. Pulse test.
3. Surface Mounted on 1 in<sub>2</sub> copper pad of FR4 Board.

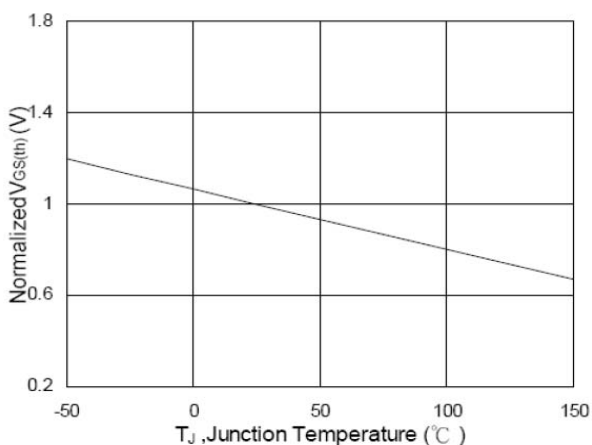
**CHARACTERISTICS CURVE**



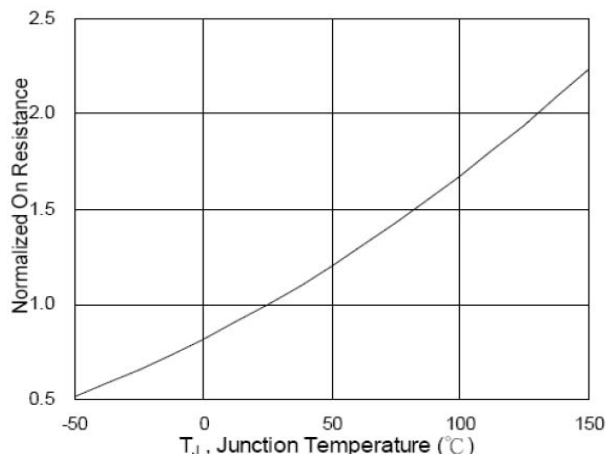
**Fig 1. Typical Output Characteristics**



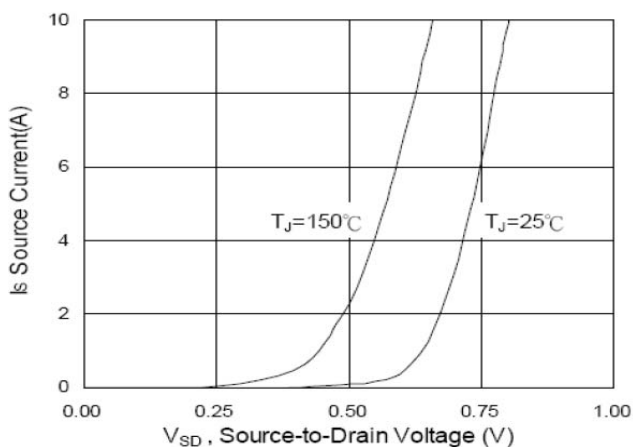
**Fig 2. On-Resistance vs. Gate-Source**



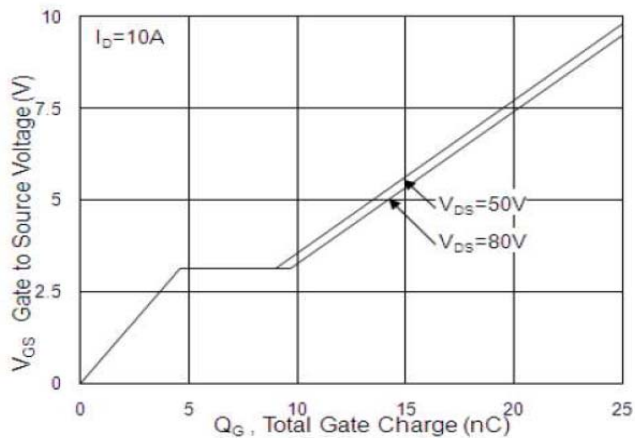
**Fig 3. Gate Threshold Voltage vs. Junction Temperature**



**Fig 4. On-Resistance vs. Junction Temperature**

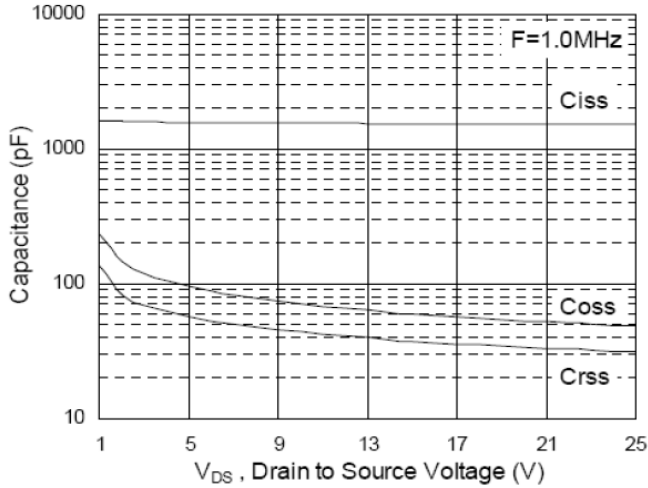


**Fig 5. Forward Characteristics of Reverse Diode**

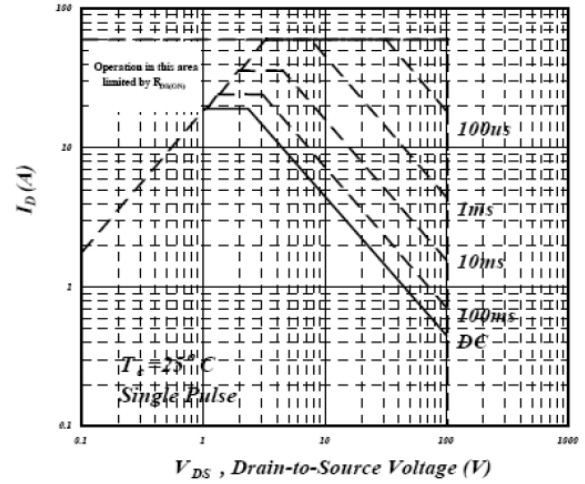


**Fig 6. Gate Charge Characteristics**

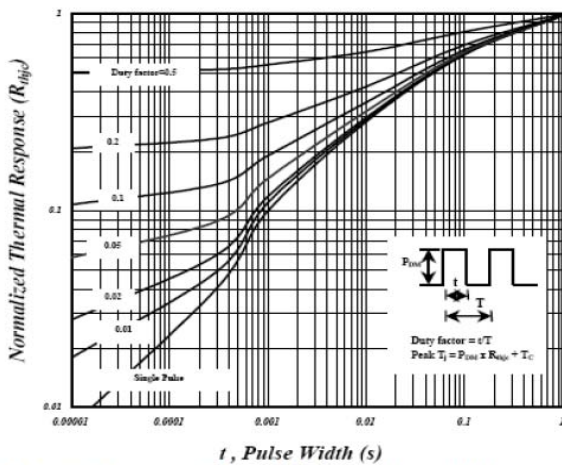
**CHARACTERISTICS CURVE**



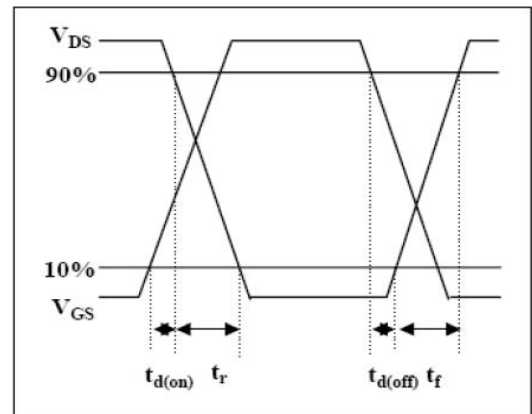
**Fig 7. Typical Capacitance Characteristics**



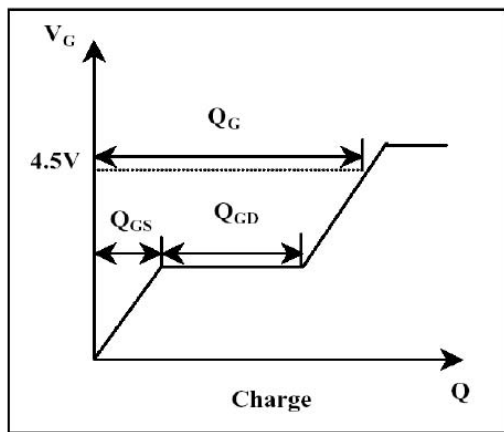
**Fig 8. Maximum Safe Operating Area**



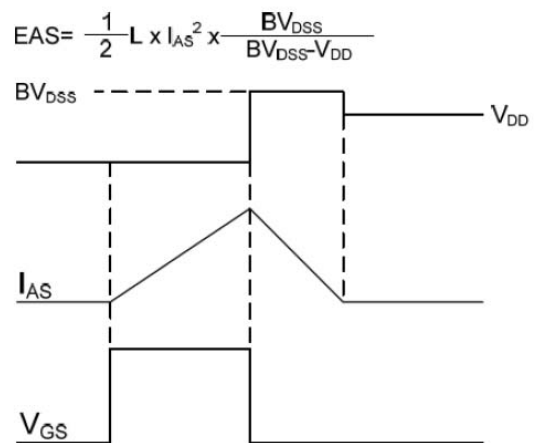
**Fig 9. Normalized Transient Thermal Resistance vs. Pulse Width**



**Fig 10. Switching Time Waveform**



**Fig 11. Gate Charge Waveform**



**Fig 12. Unclamped Inductive Switching Waveform**