

16F020 快速恢复外延二极管

* 主要用途：

开关模式电源，UPS 电源
电机控制器
高频 DC-DC 转换器

* 主要特点：

超快恢复时间
漏电流小
低正向电压
高雪崩能量

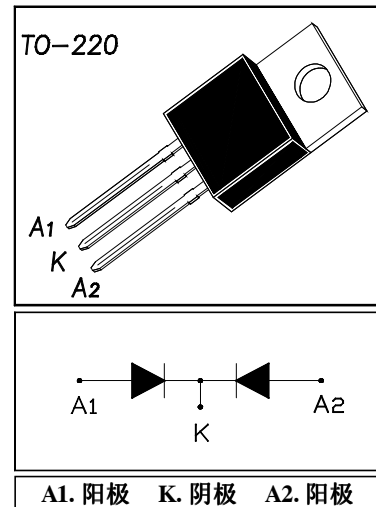

* 电特性： 没有其他说明时 $T_c=25\text{ }^\circ\text{C}$

符号	参数	测试条件	最小值	标准值	最大值	单位
V_R	D.C. 反向电压		200			V
V_{RRM}	最大反向重复峰值电压		200			V
$I_{F(AV)}$	平均正向电流	$T_c=125\text{ }^\circ\text{C}$, 占空比 =0.5	8×2			A
$I_{F(RMS)}$	RMS 正向电流	方波, 占空比 =0.5	20×2			A
I_{FSM}	无重复正向冲击电流	$T_j=45\text{ }^\circ\text{C}$, 8.3ms	100			μA
I_{RM}	最大反向漏电流	$V_R=200\text{V}, T_j=25\text{ }^\circ\text{C}$ $V_R=200\text{V}, T_j=150\text{ }^\circ\text{C}$			25 150	μA
V_F	正向电压	$I_F=8\text{A}, T_j=25\text{ }^\circ\text{C}$ $I_F=8\text{A}, T_j=150\text{ }^\circ\text{C}$		1.1 0.9	1.2	V
T_{rr}	反向恢复时间	$I_F=1\text{A}, \text{dif}/\text{dt}=-200\text{A}/\mu\text{s}$ $V_R=30\text{V}, T_j=25\text{ }^\circ\text{C}$				ns
T_{rr}	反向恢复时间	$I_F=8\text{A}, \text{dif}/\text{dt}=-200\text{A}/\mu\text{s}$ $V_R=100\text{V}, T_c=100\text{ }^\circ\text{C}$		45		ns
Q_{rr}	反向恢复电荷			180		nC
I_{RRM}	反向恢复电流			4.5		A
$R_{\theta JC}$	热阻				2.5	$^\circ\text{C}/\text{W}$
T_j, T_{STG}	工作以及储存温度范围		-55		+175	$^\circ\text{C}$

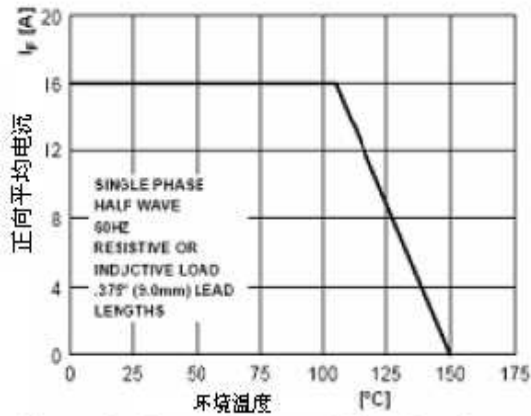
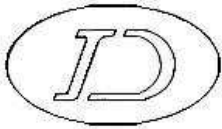

Figure 1. Forward Current Derating Curve

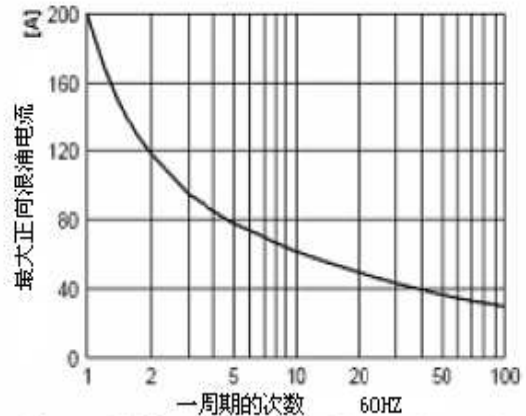

Figure 2. Non-Repetitive Surge Current Reverse Characteristics

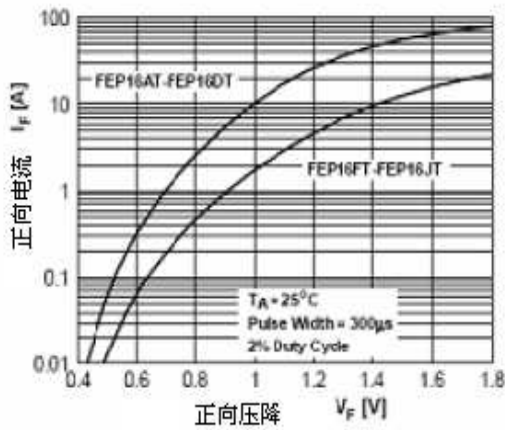

Figure 3. Forward Voltage Characteristics

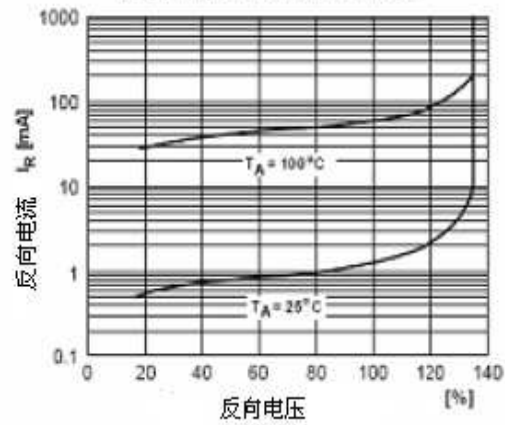

Figure 4. Reverse Current vs Reverse Voltage

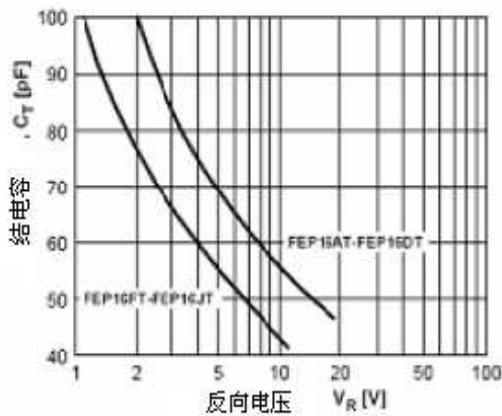
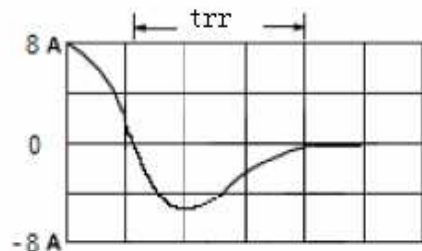
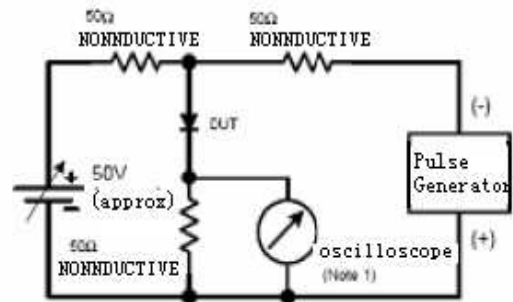
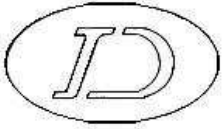

Figure 5. Total Capacitance



Reverse Recovery Time Characteristic and Test Circuit Diagram



封装形式:

TO-220 (单位: mm, 无其他特别说明公差 $\pm 0.1\text{mm}$)

