

# RFD16N03L, RFD16N03LSM

## 16A, 30V, Avalanche Rated N-Channel Logic Level Enhancement-Mode Power MOSFETs

December 1995

### Features

- 16A, 30V
- $r_{DS(ON)} = 0.022\Omega$
- *Temperature Compensating* PSPICE Model
- Can be Driven Directly from CMOS, NMOS, and TTL Circuits
- Peak Current vs Pulse Width Curve
- UIS Rating Curve
- +175°C Operating Temperature

### Description

The RFD16N03L and RFD16N03LSM are N-channel power MOSFETs manufactured using the MegaFET process. This process, which uses feature sizes approaching those of LSI circuits, gives optimum utilization of silicon, resulting in outstanding performance. They were designed for use in applications such as switching regulators, switching converters, motor drivers and relay drivers. This performance is accomplished through a special gate oxide design which provides full rated conductance at gate bias in the 3V - 5V range, thereby facilitating true on-off power control directly from logic level (5V) integrated circuits.

#### PACKAGE AVAILABILITY

PART NUMBER	PACKAGE	BRAND
RFD16N03L	TO-251AA	16N03L
RFD16N03LSM	TO-252AA	16N03L

NOTE: When ordering, use the entire part number. Add the suffix 9A, to obtain the TO-252AA variant in tape and reel, e.g. RFD16N03LSM9A.

Formerly developmental type TA49030.

### Packaging

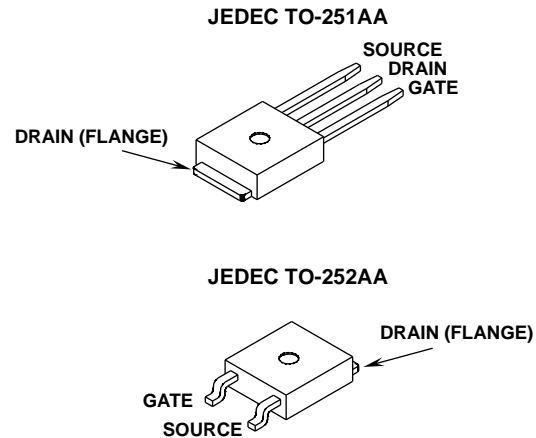

### Symbol

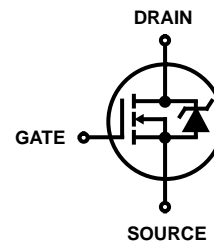

### Absolute Maximum Ratings $T_C = +25^\circ\text{C}$

	RFD16N03L, RFD16N03LSM	UNITS
Drain-Source Voltage . . . . . $V_{DSS}$	30	V
Drain-Gate Voltage . . . . . $V_{DGR}$	30	V
Gate-Source Voltage . . . . . $V_{GS}$	$\pm 10$	V
Drain Current		
RMS Continuous . . . . . $I_D$	16	A
Pulsed Drain Current . . . . . $I_{DM}$	Refer to Peak Current Curve	
Pulsed Avalanche Rating . . . . . $E_{AS}$	Refer to UIS Curve	
Power Dissipation		
$T_C = +25^\circ\text{C}$ . . . . . $P_D$	90	W
Derate above $+25^\circ\text{C}$ . . . . .	0.606	W/ $^\circ\text{C}$
Operating and Storage Temperature . . . . . $T_{STG}, T_J$	-55 to +175	$^\circ\text{C}$
Soldering Temperature of Leads for 10s . . . . . $T_L$	260	$^\circ\text{C}$

## Specifications RFD16N03L, RFD16N03LSM

### Electrical Specifications $T_C = +25^\circ\text{C}$ , Unless Otherwise Specified

PARAMETERS	SYMBOL	TEST CONDITIONS	MIN	TYP	MAX	UNITS	
Drain-Source Breakdown Voltage	$BV_{DSS}$	$I_D = 250\mu\text{A}$ , $V_{GS} = 0\text{V}$	30	-	-	V	
Gate Threshold Voltage	$V_{GS(TH)}$	$V_{GS} = V_{DS}$ , $I_D = 250\mu\text{A}$	1	-	2	V	
Zero Gate Voltage Drain Current	$I_{DSS}$	$V_{DS} = 30\text{V}$ , $V_{GS} = 0\text{V}$	$T_C = +25^\circ\text{C}$	-	-	1	$\mu\text{A}$
			$T_C = +150^\circ\text{C}$	-	-	50	$\mu\text{A}$
Gate-Source Leakage Current	$I_{GSS}$	$V_{GS} = \pm 10\text{V}$	-	-	100	nA	
On Resistance	$r_{DS(ON)}$	$I_D = 16\text{A}$ , $V_{GS} = 5\text{V}$	-	-	0.022	$\Omega$	
Turn-On Time	$t_{ON}$	$V_{DD} = 15\text{V}$ , $I_D = 16\text{A}$ , $R_L = 0.93\Omega$ , $V_{GS} = 5\text{V}$ , $R_{GS} = 5\Omega$	-	-	120	ns	
Turn-On Delay Time	$t_{D(ON)}$		-	15	-	ns	
Rise Time	$t_R$		-	95	-	ns	
Turn-Off Delay Time	$t_{D(OFF)}$		-	25	-	ns	
Fall Time	$t_F$		-	27	-	ns	
Turn-Off Time	$t_{OFF}$		-	-	80	ns	
Total Gate Charge	$Q_{G(TOT)}$		$V_{GS} = 0\text{V to } 10\text{V}$	$V_{DD} = 24\text{V}$ , $I_D = 16\text{A}$ , $R_L = 1.5\Omega$	-	50	60
Gate Charge at 5V	$Q_{G(5)}$	$V_{GS} = 0\text{V to } 5\text{V}$	-		30	36	nC
Threshold Gate Charge	$Q_{G(TH)}$	$V_{GS} = 0\text{V to } 1\text{V}$	-		1.5	1.8	nC
Input Capacitance	$C_{ISS}$	$V_{DS} = 25\text{V}$ , $V_{GS} = 0\text{V}$ , $f = 1\text{MHz}$	-	1650	-	pF	
Output Capacitance	$C_{OSS}$		-	575	-	pF	
Reverse Transfer Capacitance	$C_{RSS}$		-	200	-	pF	
Thermal Resistance Junction-to-Case	$R_{\theta JC}$		-	-	1.65	$^\circ\text{C/W}$	
Thermal Resistance Junction-to-Ambient	$R_{\theta JA}$	TO-251 and TO-252	-	-	100	$^\circ\text{C/W}$	

### Source-Drain Diode Specifications

PARAMETERS	SYMBOL	TEST CONDITIONS	MIN	TYP	MAX	UNITS
Forward Voltage	$V_{SD}$	$I_{SD} = 16\text{A}$	-	-	1.5	V
Reverse Recovery Time	$t_{RR}$	$I_{SD} = 16\text{A}$ , $dI_{SD}/dt = 100\text{A}/\mu\text{s}$	-	-	75	ns

Typical Performance Curves

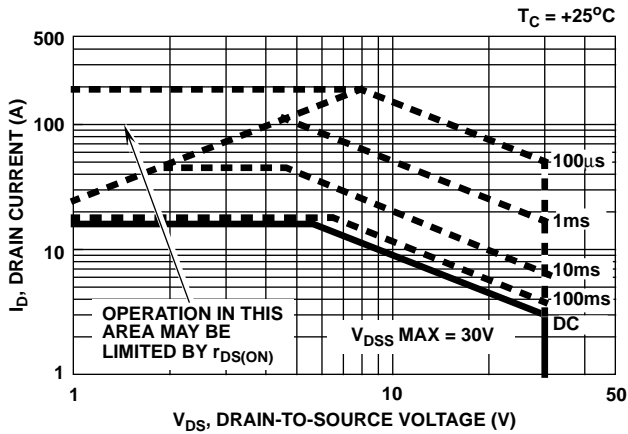

FIGURE 1. SAFE OPERATING AREA CURVE

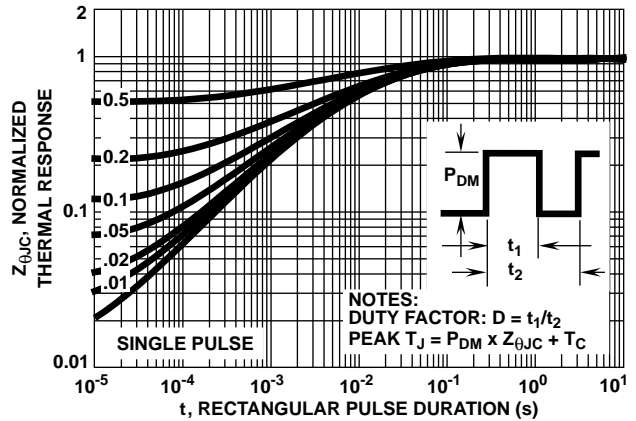

FIGURE 2. NORMALIZED MAXIMUM TRANSIENT THERMAL IMPEDANCE

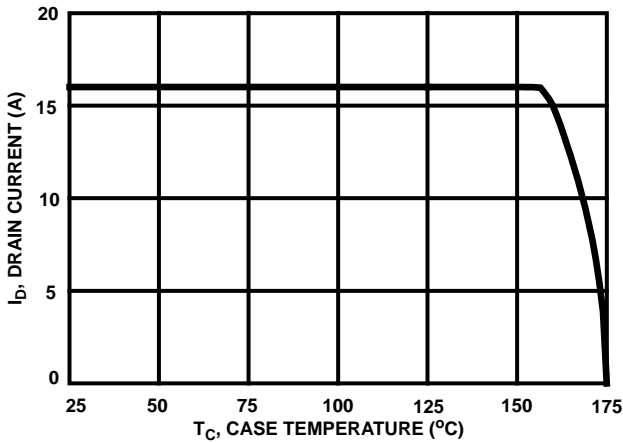

FIGURE 3. MAXIMUM CONTINUOUS DRAIN CURRENT vs TEMPERATURE

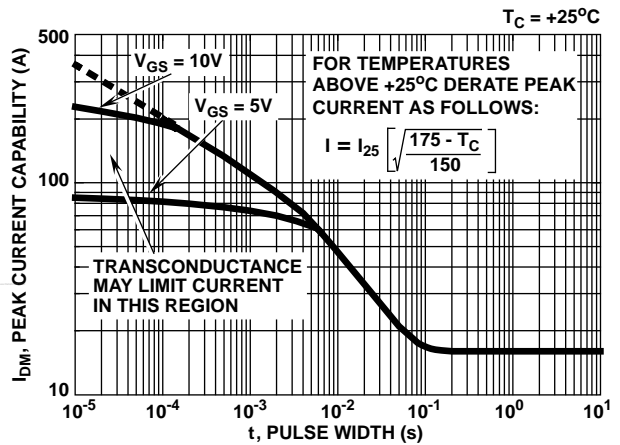

FIGURE 4. PEAK CURRENT CAPABILITY

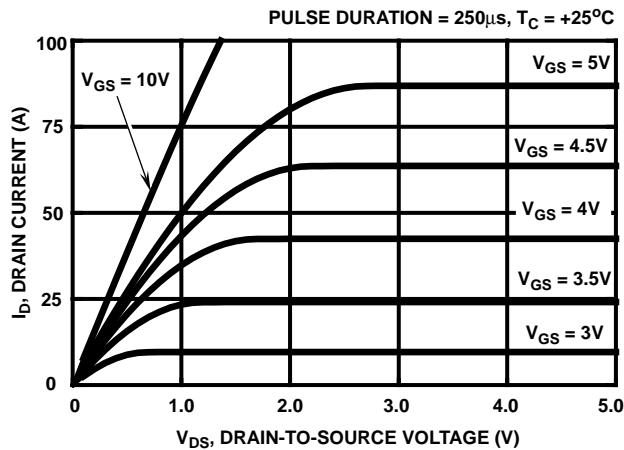

FIGURE 5. TYPICAL SATURATION CHARACTERISTICS

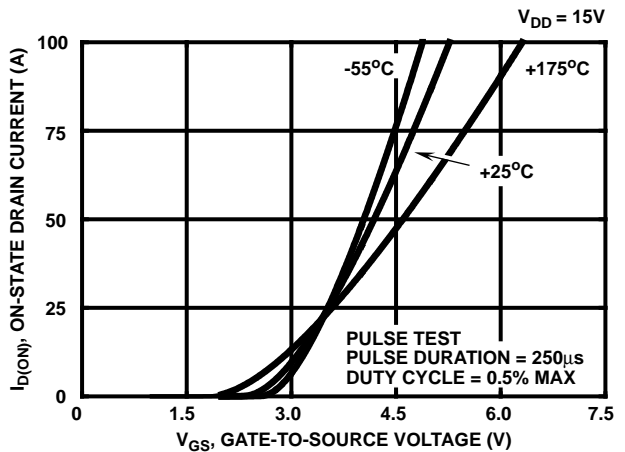

FIGURE 6. TYPICAL TRANSFER CHARACTERISTICS

Typical Performance Curves (Continued)

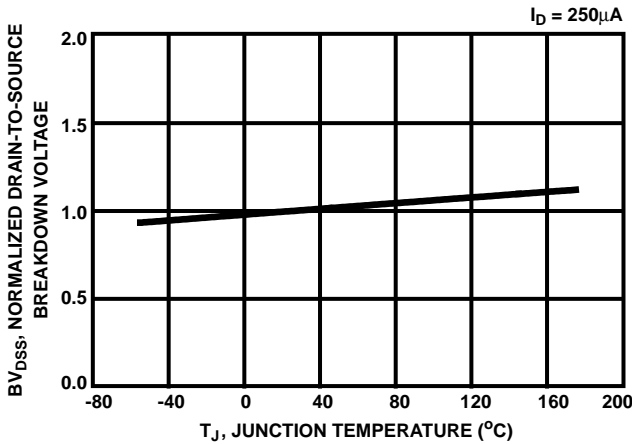

FIGURE 7. NORMALIZED DRAIN-SOURCE BREAKDOWN VOLTAGE vs JUNCTION TEMPERATURE

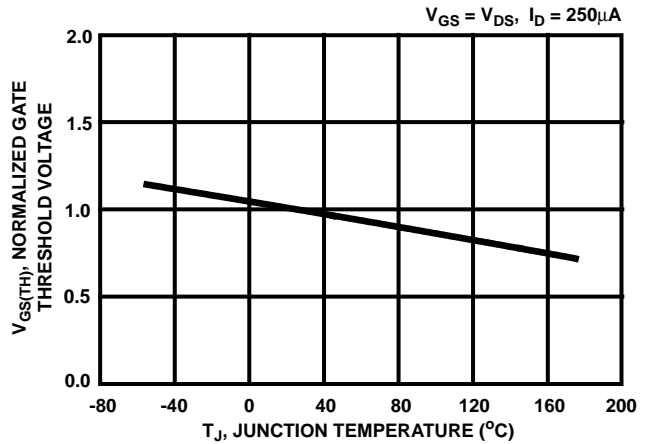

FIGURE 8. NORMALIZED GATE THRESHOLD VOLTAGE vs JUNCTION TEMPERATURE

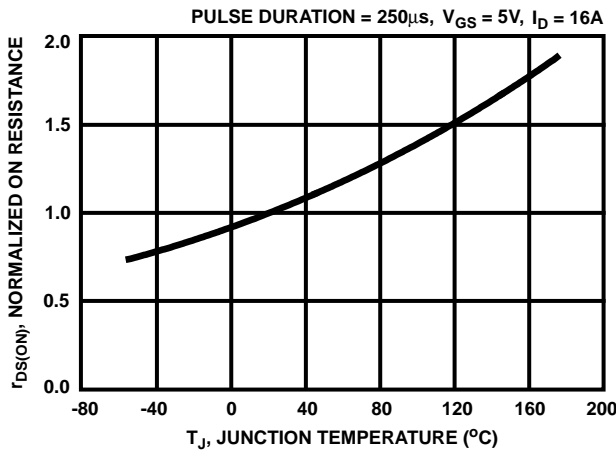

FIGURE 9. NORMALIZED  $r_{DS(ON)}$  vs JUNCTION TEMPERATURE

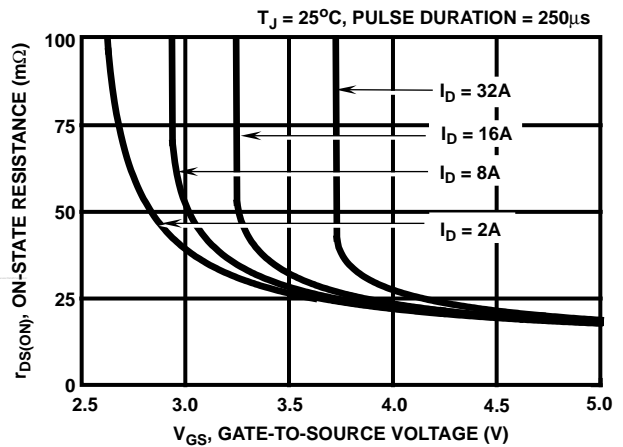

FIGURE 10. TYPICAL  $r_{DS(ON)}$  FOR VARYING CONDITIONS OF GATE VOLTAGE AND DRAIN CURRENT

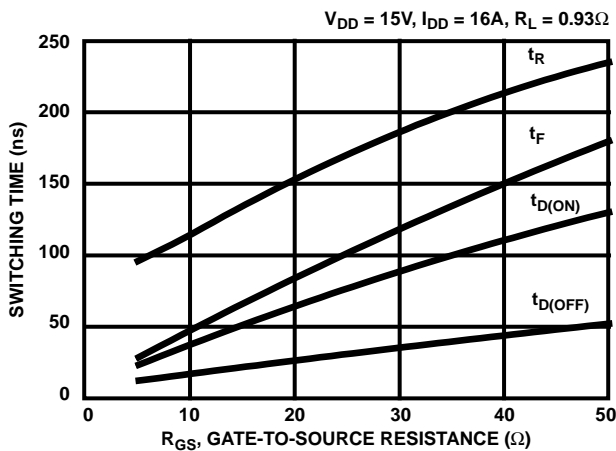

FIGURE 11. TYPICAL SWITCHING TIME AS A FUNCTION OF GATE RESISTANCE

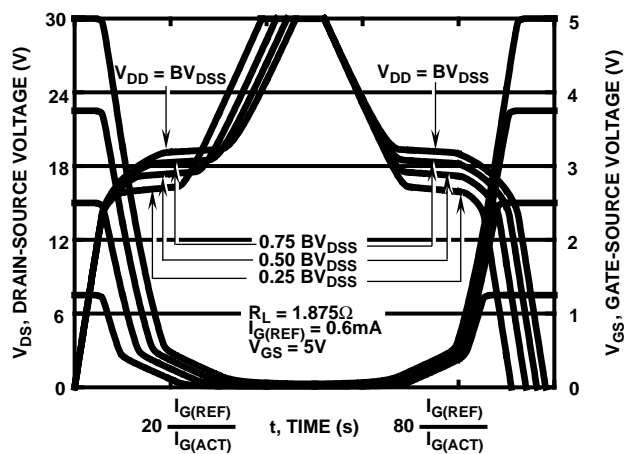

FIGURE 12. NORMALIZED SWITCHING WAVEFORMS FOR CONSTANT GATE CURRENT. REFER TO HARRIS APPLICATION NOTES AN7254 AND AN7260

Typical Performance Curves (Continued)

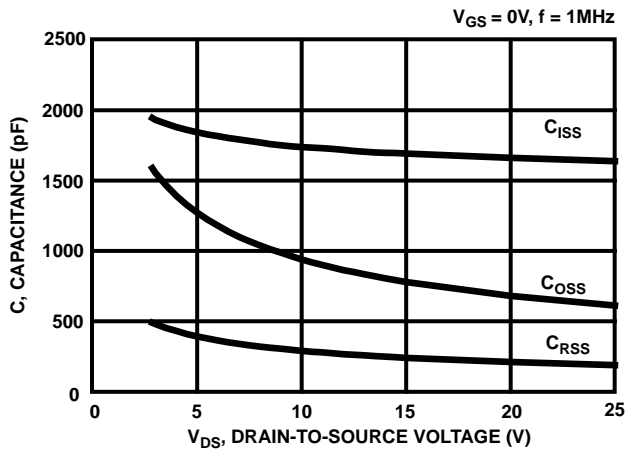

FIGURE 13. TYPICAL CAPACITANCE vs VOLTAGE

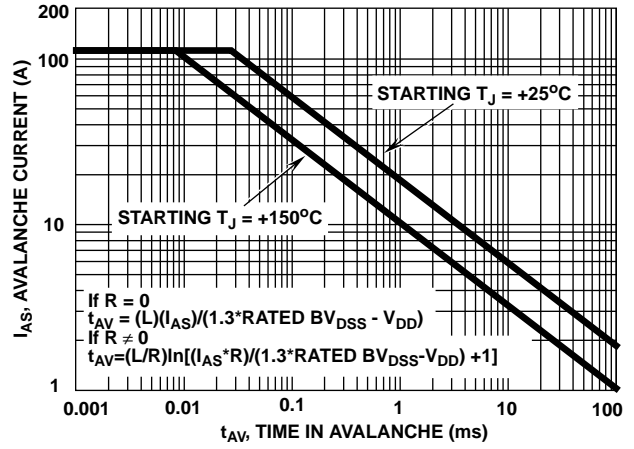

FIGURE 14. UNCLAMPED INDUCTIVE SWITCHING. REFER TO HARRIS APPLICATION NOTES AN9321 AND AN9322

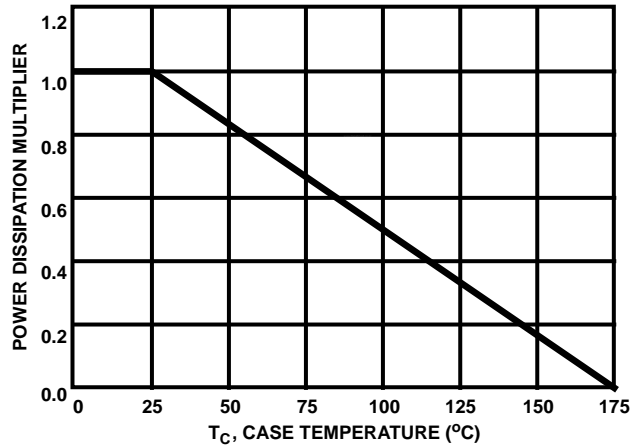

FIGURE 15. NORMALIZED POWER DISSIPATION vs TEMPERATURE DERATING CURVE

Test Circuits and Waveforms

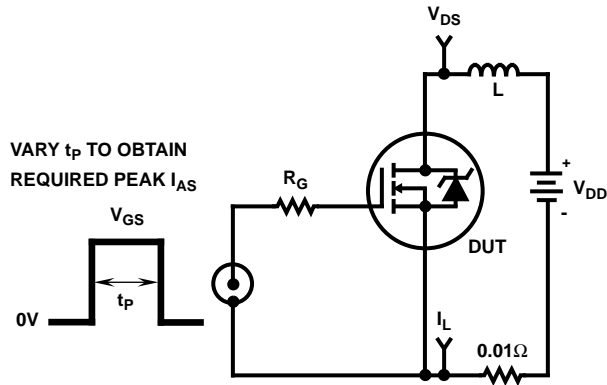

FIGURE 16. UNCLAMPED ENERGY TEST CIRCUIT

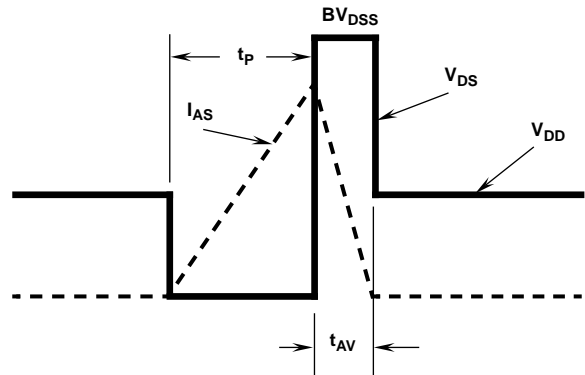

FIGURE 17. UNCLAMPED ENERGY WAVEFORMS

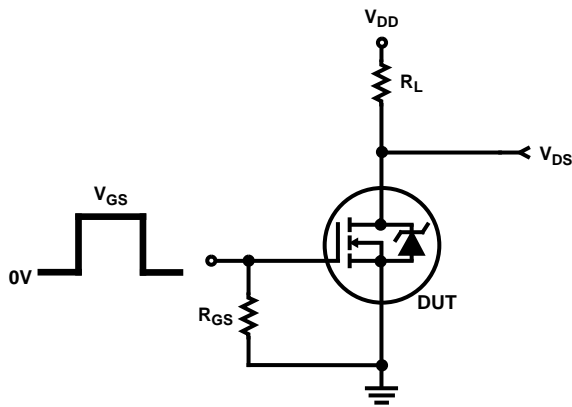

FIGURE 18. RESISTIVE SWITCHING TEST CIRCUIT

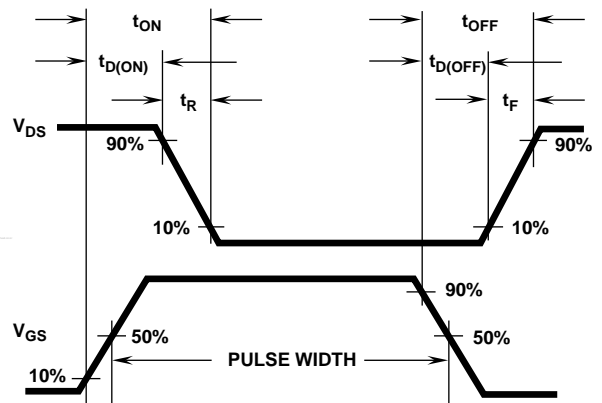

FIGURE 19. RESISTIVE SWITCHING WAVEFORMS

## RFD16N03L, RFD16N03LSM

### Temperature Compensated PSPICE Model for the RFD16N03L, RFD16N03LSM

.SUBCKT RFD16N03L 2 1 3; rev 12/12/94

CA 12 8 2.55e-9  
 CB 15 14 2.64e-9  
 CIN 6 8 1.45e-9

DBODY 7 5 DBDMOD  
 DBREAK 5 11 DBKMOD  
 DPLCAP 10 5 DPLCAPMOD

EBREAK 11 7 17 18 33.3

EDS 14 8 5 8 1  
 EGS 13 8 6 8 1  
 ESG 6 10 6 8 1  
 EVTO 20 6 18 8 1

IT 8 17 1

LDRAIN 2 5 1e-9  
 LGATE 1 9 3.4e-9  
 LSOURCE 3 7 3.4e-9

MOS1 16 6 8 8 MOSMOD M = 0.99  
 MOS2 16 21 8 8 MOSMOD M = 0.01

RBREAK 17 18 RBKMOD 1  
 RDRAIN 50 16 RDSMOD 0.14e-3  
 RGATE 9 20 0.89  
 RIN 6 8 1e9  
 RSCL1 5 51 RSCLMOD 1e-6  
 RSCL2 5 50 1e3  
 RSOURCE 8 7 RDSMOD 10.31e-3  
 RVTO 18 19 RVTOMOD 1

S1A 6 12 13 8 S1AMOD  
 S1B 13 12 13 8 S1BMOD  
 S2A 6 15 14 13 S2AMOD  
 S2B 13 15 14 13 S2BMOD

VBAT 8 19 DC 1  
 VTO 21 6 0.583

ESCL 51 50 VALUE = {(V(5,51)/ABS(V(5,51)))\*(PWR(V(5,51)\*1e6/176,6))}

.MODEL DBDMOD D (IS = 3.61e-13 RS = 5.06e-3 TRS1 = 3.05e-3 TRS2 = 7.57e-6 CJO = 2.16e-9 TT = 2.18e-8)  
 .MODEL DBKMOD D (RS = 1.66e-1 TRS1 = -2.97e-3 TRS2 = 7.57e-6)  
 .MODEL DPLCAPMOD D (CJO = 0.96e-9 IS = 1e-30 N = 10)  
 .MODEL MOSMOD NMOS (VTO = 2.313 KP = 53.82 IS = 1e-30 N = 10 TOX = 1 L = 1u W = 1u)  
 .MODEL RBKMOD RES (TC1 = 8.95e-4 TC2 = -1e-7)  
 .MODEL RDSMOD RES (TC1 = 3.92e-3 TC2 = 1.29e-5)  
 .MODEL RSCLMOD RES (TC1 = 2.03e-3 TC2 = 0.45e-5)  
 .MODEL RVTOMOD RES (TC1 = -2.27e-3 TC2 = -5.75e-7)  
 .MODEL S1AMOD VSWITCH (RON = 1e-5 ROFF = 0.1 VON = -4.82 VOFF = -2.82)  
 .MODEL S1BMOD VSWITCH (RON = 1e-5 ROFF = 0.1 VON = -2.82 VOFF = -4.82)  
 .MODEL S2AMOD VSWITCH (RON = 1e-5 ROFF = 0.1 VON = -2.67 VOFF = 2.33)  
 .MODEL S2BMOD VSWITCH (RON = 1e-5 ROFF = 0.1 VON = 2.33 VOFF = -2.67)

.ENDS

NOTE: For further discussion of the PSPICE model, consult **A New PSPICE Sub-circuit for the Power MOSFET Featuring Global Temperature Options**; written by William J. Hepp and C. Frank Wheatley.

