

# International IOR Rectifier

## 18TQ... 18TQ...S

SCHOTTKY RECTIFIER

18 Amp

$I_{F(AV)} = 18\text{Amp}$   
 $V_R = 35 \text{ to } 45\text{V}$

### Major Ratings and Characteristics

Characteristics	18TQ	Units
$I_{F(AV)}$ Rectangular waveform	18	A
$V_{RRM}$ range	35 to 45	V
$I_{FSM}$ @tp = 5 $\mu$ s sine	1800	A
$V_F$ @18 Apk, $T_J = 125^\circ\text{C}$	0.53	V
$T_J$ range	-55 to 175	$^\circ\text{C}$

### Description/Features

The 18TQ Schottky rectifier series has been optimized for low reverse leakage at high temperature. The proprietary barrier technology allows for reliable operation up to 175°C junction temperature. Typical applications are in switching power supplies, converters, free-wheeling diodes, and reverse battery protection.

- 175° C  $T_J$  operation
- High purity, high temperature epoxy encapsulation for enhanced mechanical strength and moisture resistance
- Low forward voltage drop
- High frequency operation
- Guard ring for enhanced ruggedness and long term reliability

### Case Styles

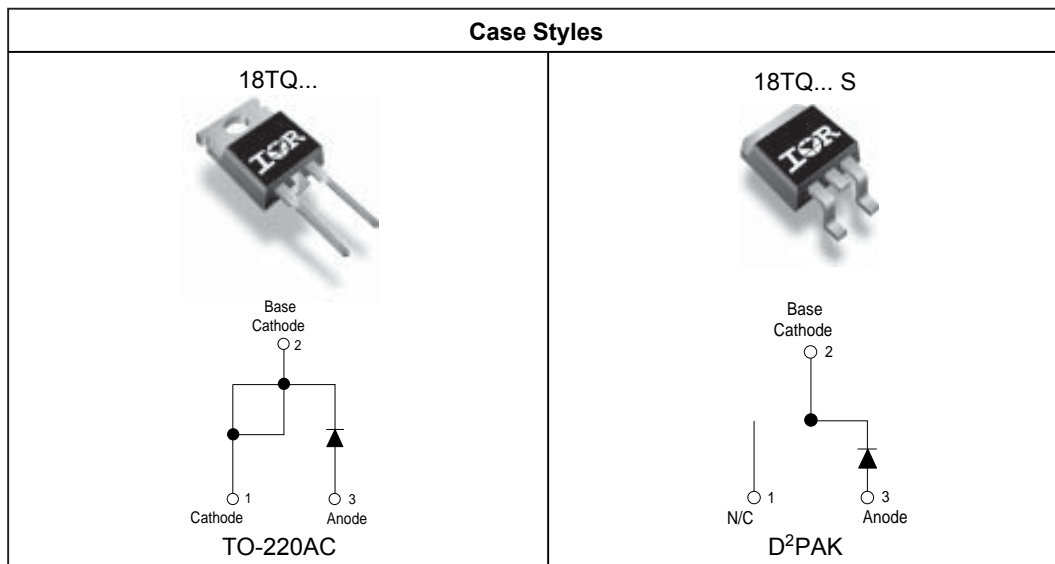

## Voltage Ratings

Part number	18TQ035	18TQ040	18TQ045
$V_R$ Max. DC Reverse Voltage (V)	35	40	45
$V_{RWM}$ Max. Working Peak Reverse Voltage (V)			

## Absolute Maximum Ratings

Parameters	18TQ	Units	Conditions
$I_{F(AV)}$ Max. Average Forward Current * See Fig. 5	18	A	50% duty cycle @ $T_C = 149^\circ\text{C}$ , rectangular wave form
$I_{FSM}$ Max. Peak One Cycle Non-Repetitive Surge Current * See Fig. 7	1800	A	Following any rated load condition and with rated $V_{RWM}$ applied
	390		
$E_{AS}$ Non-Repetitive Avalanche Energy	24	mJ	$T_J = 25^\circ\text{C}$ , $I_{AS} = 3.6\text{Amps}$ , $L = 3.7\text{mH}$
$I_{AR}$ Repetitive Avalanche Current	3.6	A	Current decaying linearly to zero in 1 $\mu\text{sec}$ Frequency limited by $T_J$ max. $V_A = 1.5 \times V_R$ typical

## Electrical Specifications

Parameters	18TQ	Units	Conditions
$V_{FM}$ Max. Forward Voltage Drop (1) * See Fig. 1	0.60	V	@ 18A
	0.72	V	@ 36A
	0.53	V	@ 18A
	0.67	V	@ 36A
$I_{RM}$ Max. Reverse Leakage Current (1) * See Fig. 2	2.5	mA	$T_J = 25^\circ\text{C}$
	25	mA	$T_J = 125^\circ\text{C}$
$C_T$ Max. Junction Capacitance	1400	pF	$V_R = 5V_{DC}$ , (test signal range 100Khz to 1Mhz) $25^\circ\text{C}$
$L_S$ Typical Series Inductance	8.0	nH	Measured lead to lead 5mm from package body
$dv/dt$ Max. Voltage Rate of Change (Rated $V_R$ )	10000	V/ $\mu\text{s}$	

(1) Pulse Width < 300 $\mu\text{s}$ , Duty Cycle < 2%

## Thermal-Mechanical Specifications

Parameters	18TQ	Units	Conditions
$T_J$ Max. Junction Temperature Range	-55 to 175	$^\circ\text{C}$	
$T_{stg}$ Max. Storage Temperature Range	-55 to 175	$^\circ\text{C}$	
$R_{thJC}$ Max. Thermal Resistance Junction to Case	1.50	$^\circ\text{C/W}$	DC operation * See Fig. 4
$R_{thCS}$ Typical Thermal Resistance, Case to Heatsink	0.50	$^\circ\text{C/W}$	Mounting surface, smooth and greased
wt Approximate Weight	2 (0.07)		g (oz.)
T Mounting Torque	Min.	6 (5)	Kg-cm (lbf-in)
	Max.	12 (10)	

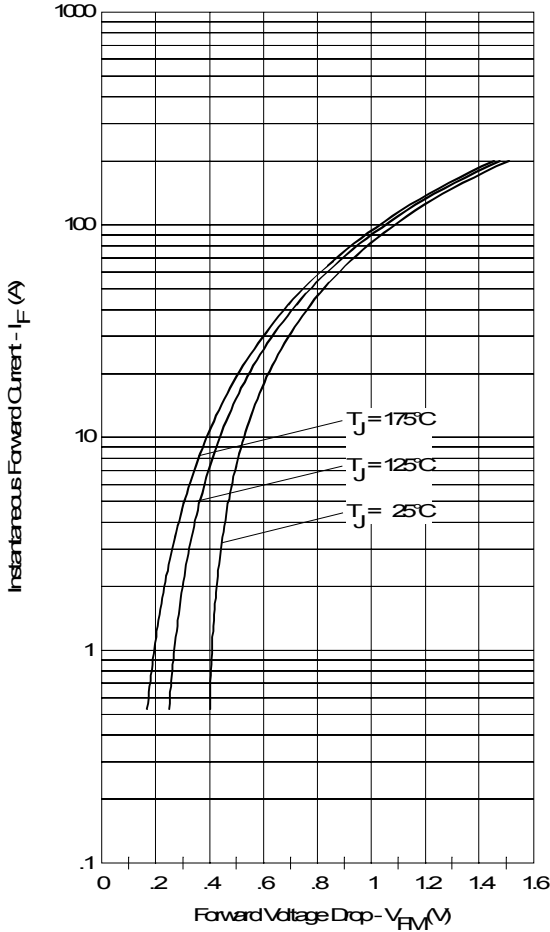

Fig. 1 - Maximum Forward Voltage Drop Characteristics

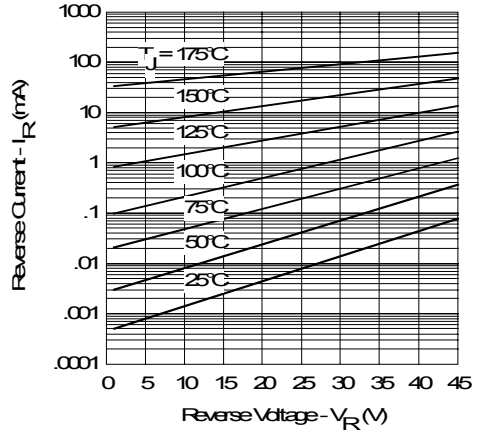

Fig. 2 - Typical Values of Reverse Current Vs. Reverse Voltage

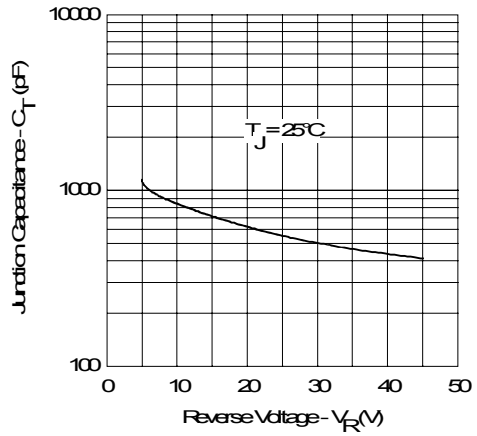

Fig. 3 - Typical Junction Capacitance Vs. Reverse Voltage

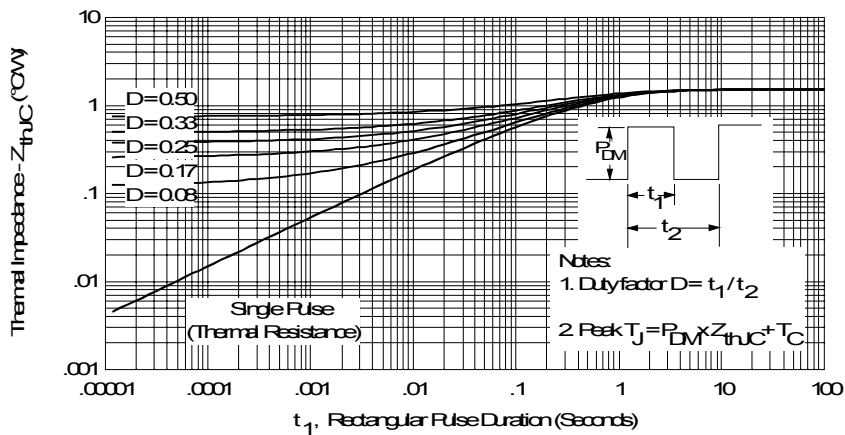

Fig. 4 - Maximum Thermal Impedance  $Z_{thJC}$  Characteristics

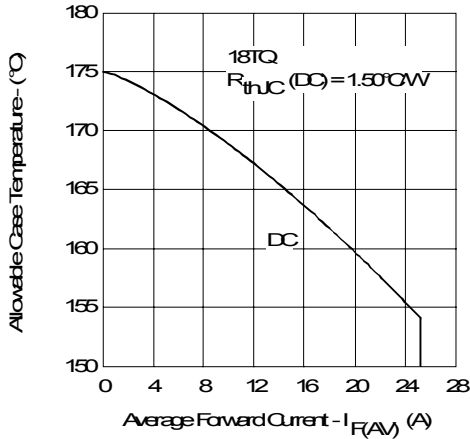

Fig. 5 - Maximum Allowable Case Temperature Vs. Average Forward Current

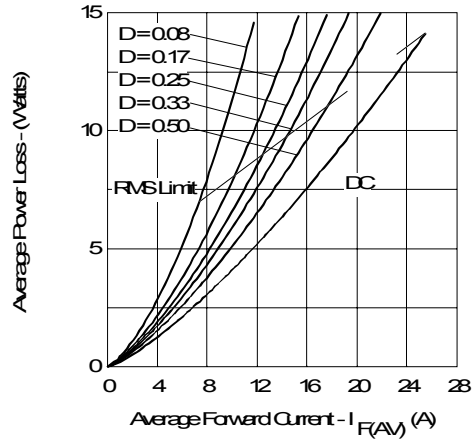

Fig. 6 - Forward Power Loss Characteristics

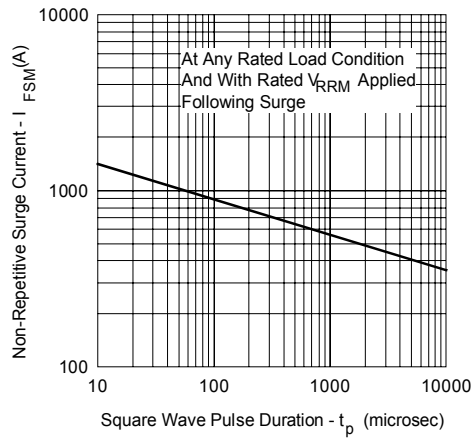

Fig. 7 - Maximum Non-Repetitive Surge Current

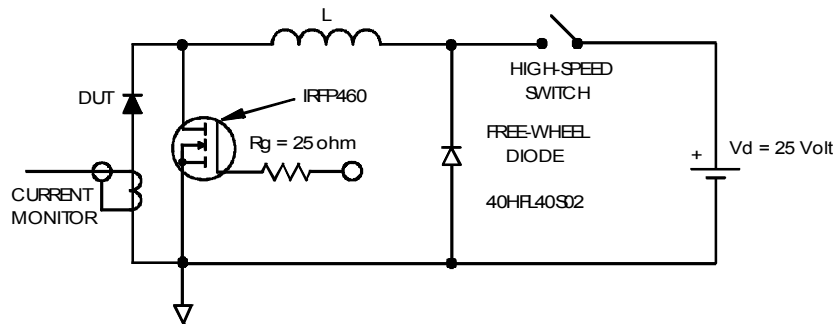
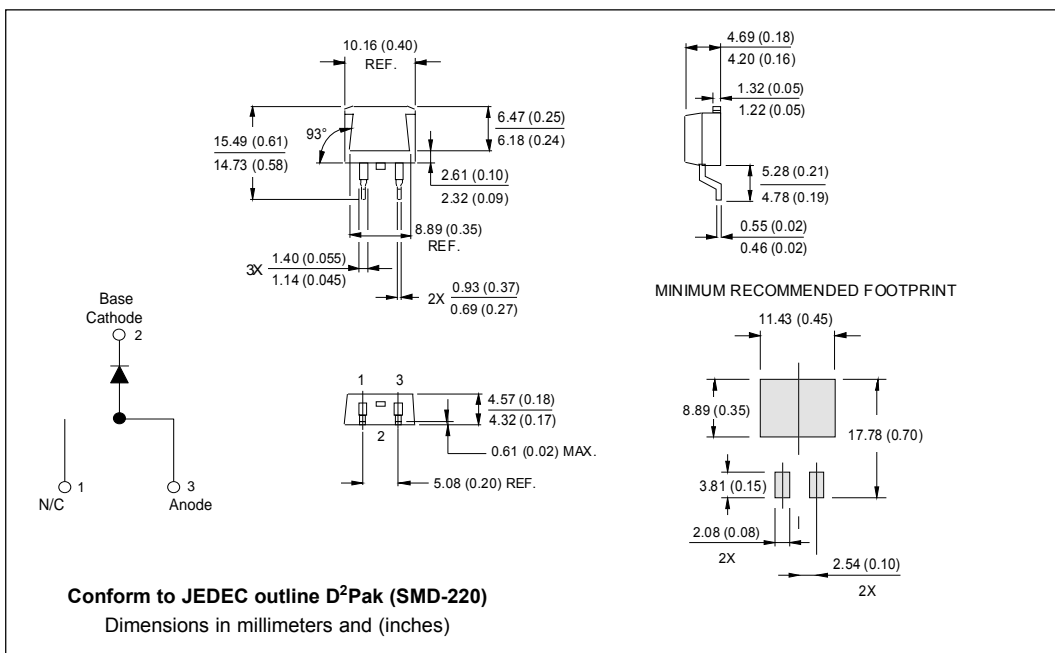
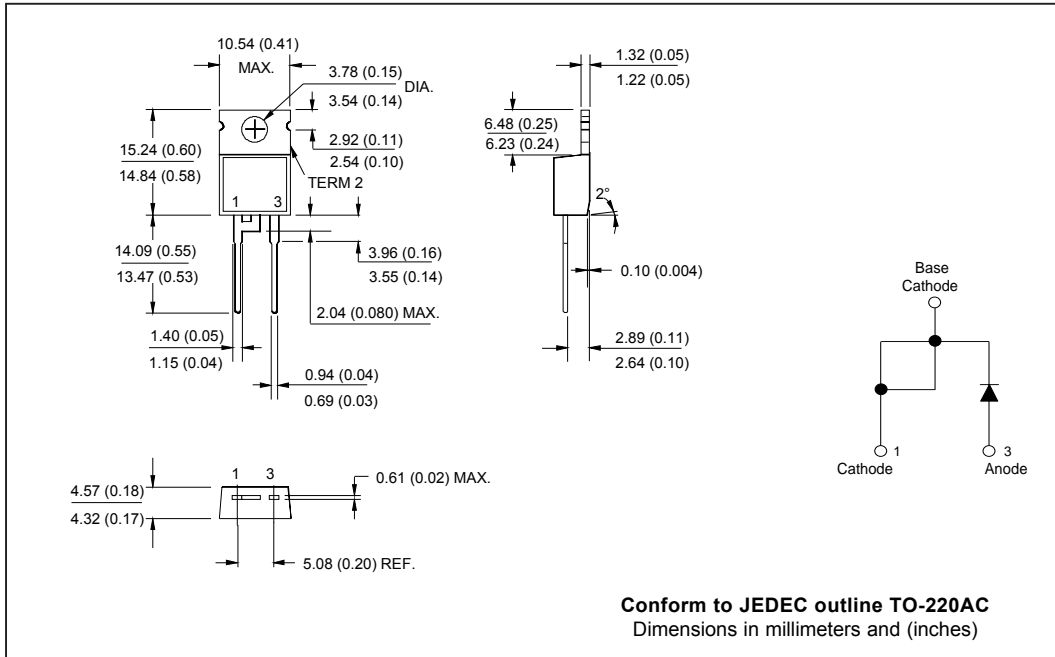
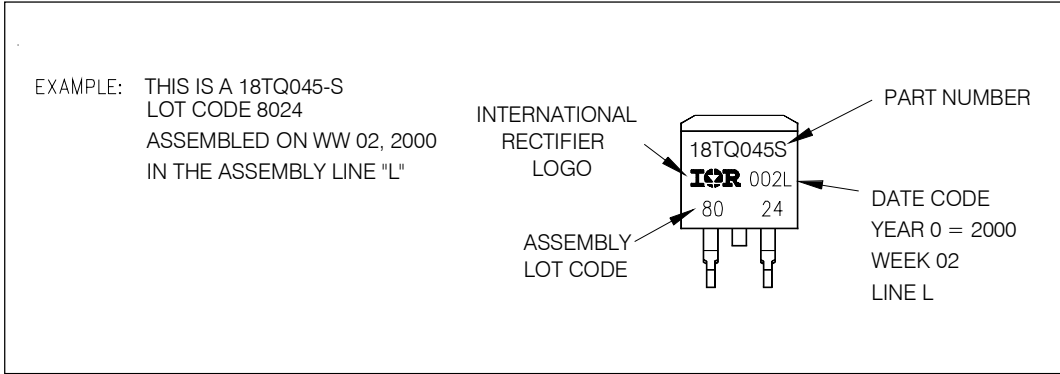

Fig. 8 - Unclamped Inductive Test Circuit

Outline Table



Marking Information



Tape & Reel Information

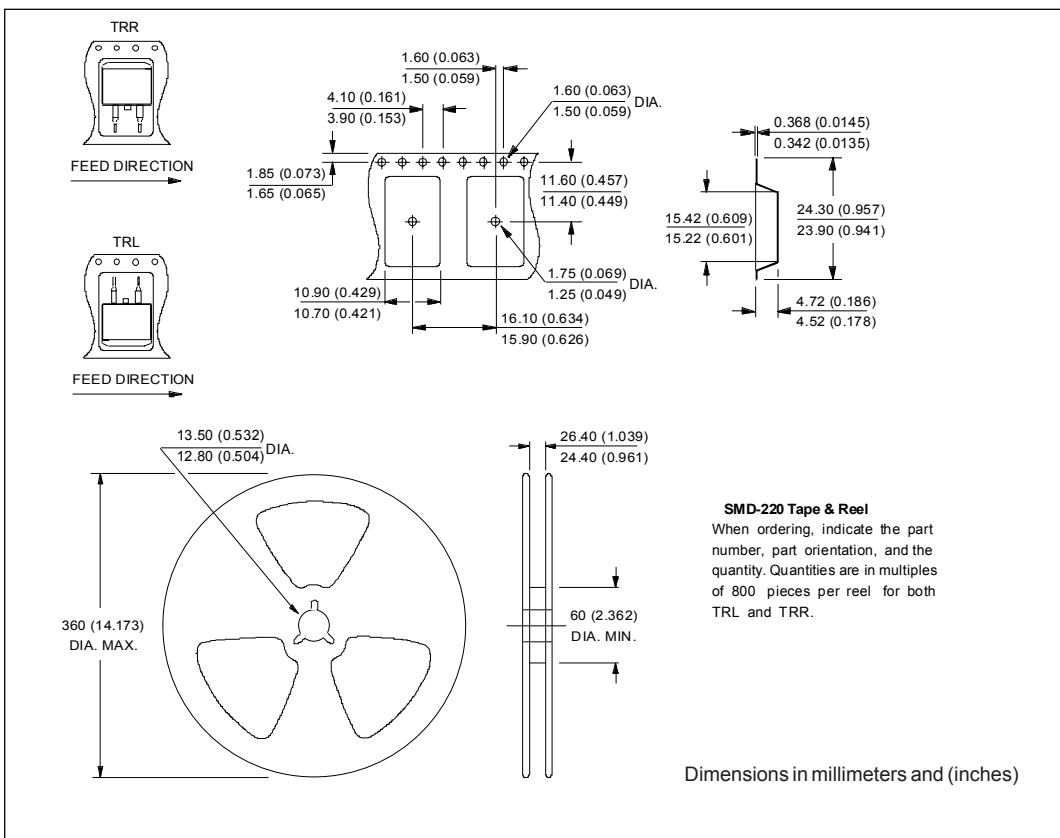

Ordering Information Table

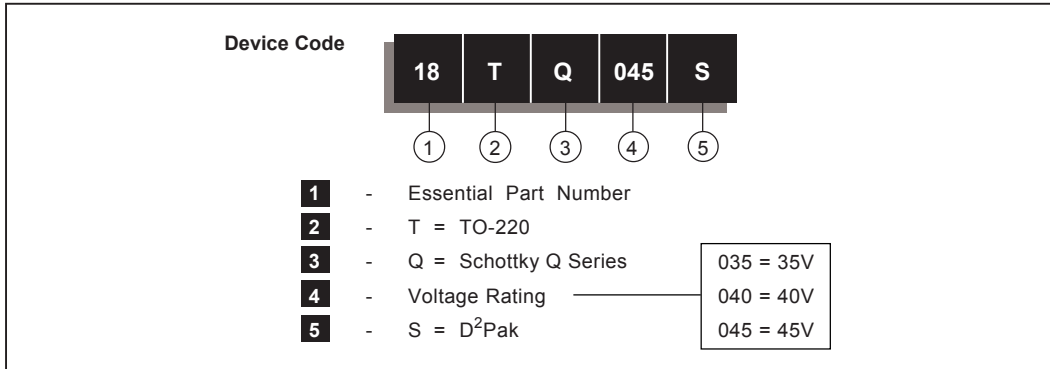

```

18TQ045
*****
* This model has been developed by *
* Wizard SPICE MODEL GENERATOR (1999) *
* (International Rectifier Corporation) *
* Contains Proprietary Information *
*****
* SPICE Model Diode is composed by a *
* simple diode plus paralld VCG2T *
*****
.SUBCKT 18TQ045 ANO CAT
D1 ANO 1 DMOD (0.10899)
*Define diode model
.MODEL DMOD D(IS=4.49213078685186E-05A,N=1.23149728754907,BV=52V,
+ IBV=9.03115410463162E-02A,RS= 0.000664839,CJO=2.73074429693125E-08,
+ VJ=0.881972575936711,XTI=2, EG=0.789061316955255)
*****
*Implementation of VCG2T
VX 1 2 DC 0V
R1 2 CAT TRES 1E-6
.MODEL TRES RES(R=1,TC1=18.1199792035774)
GP1 ANO CAT VALUE={-ABS(I(VX))*(EXP((((-3.316412E-03/18.11998)*((V(2,CAT)*1E6)/(I(VX)+1E-6)-
1))+1)*6.806625E-02*ABS(V(ANO,CAT))))-1)}
*****
.ENDS 18TQ045

Thermal Model Subcircuit
.SUBCKT 18TQ045 5 1

CTHERM1 5 4 6.49E-01
CTHERM2 4 3 3.46E+00
CTHERM3 3 2 1.63E+01
CTHERM4 2 1 3.01E+02

RTHERM1 5 4 6.77E-01
RTHERM2 4 3 5.70E-01
RTHERM1 3 2 2.05E-01
RTHERM1 2 1 3.44E-02

.ENDS 18TQ045
    
```

18TQ... Series

Bulletin PD-20178 rev. C 07/03

International  
**IOR** Rectifier

---

Data and specifications subject to change without notice.  
This product has been designed and qualified for Industrial Level.  
Qualification Standards can be found on IR's Web site.

International  
**IOR** Rectifier

**IR WORLD HEADQUARTERS:** 233 Kansas St., El Segundo, California 90245, USA Tel: (310) 252-7105  
TAC Fax: (310) 252-7309  
Visit us at [www.irf.com](http://www.irf.com) for sales contact information. 07/03