

1200V / 5A

Molded Package

■ Features

- Small molded package
- Low power loss
- Soft switching with low switching surge and noise
- High reliability, high ruggedness (RBSOA, SCSOA etc.)
- Comprehensive line-up

■ Applications

- Inverter for Motor drive
- AC and DC Servo drive amplifier
- Uninterruptible power supply

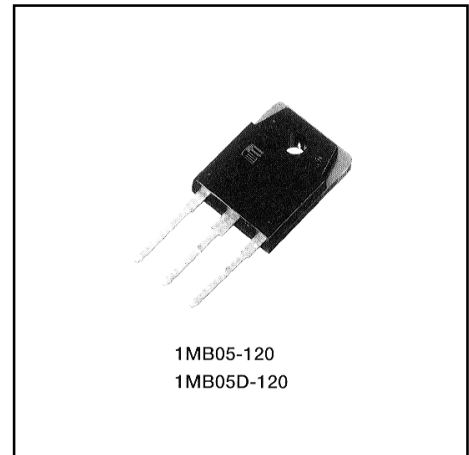

■ Maximum ratings and characteristics

- Absolute maximum ratings (at $T_c=25^\circ\text{C}$ unless otherwise specified)

1MB05-120 / IGBT

Item	Symbol	Rating	Unit		
Collector-Emitter voltage	V_{CES}	1200	V		
Gate-Emitter voltage	V_{GES}	± 20	V		
Collector current	DC	$T_c=25^\circ\text{C}$	I_{c25}	9	A
		$T_c=100^\circ\text{C}$	I_{c100}	5	A
	1ms	$T_c=25^\circ\text{C}$	I_{cp}	27	A
Max. power dissipation(IGBT)	P_c	100	W		
Operating temperature	T_j	+150	$^\circ\text{C}$		
Storage temperature	T_{stg}	-40 to +150	$^\circ\text{C}$		
Screw torque	-	50	N·m		

1MB05D-120 / IGBT+FWD

Item	Symbol	Rating	Unit		
Collector-Emitter voltage	V_{CES}	1200	V		
Gate-Emitter voltage	V_{GES}	± 20	V		
Collector current	DC	$T_c=25^\circ\text{C}$	I_{c25}	9	A
		$T_c=100^\circ\text{C}$	I_{c100}	5	A
	1ms	$T_c=25^\circ\text{C}$	I_{cp}	27	A
Max. power dissipation (IGBT)	P_c	100	W		
Max. power dissipation (FWD)	P_c	60	W		
Operating temperature	T_j	+150	$^\circ\text{C}$		
Storage temperature	T_{stg}	-40 to +150	$^\circ\text{C}$		
Screw torque	-	50	N·m		

■ Equivalent Circuit Schematic

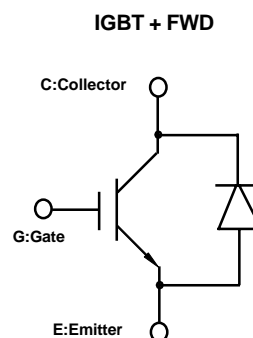
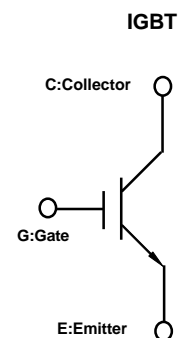

● Electrical characteristics (at Tj=25°C unless otherwise specified)

1MB05-120 / IGBT

Item	Symbol	Characteristics			Conditions	Unit
		Min.	Typ.	Max.		
Zero gate voltage collector current	ICES	–	–	1.0	VGE=0V, VCE=1200V	mA
Gate-Emitter leakage current	IGES	–	–	20	VCE=0V, VGE=±20V	µA
Gate-Emitter threshold voltage	VGE(th)	5.5	–	8.5	VCE=20V, Ic=5mA	V
Collector-Emitter saturation voltage	VCE(sat)	–	–	3.5	VGE=15V, Ic=5A	V
Input capacitance	Cies	–	650	–	VGE=0V	pF
Output capacitance	Coes	–	150	–	VCE=10V	
Reverse transfer capacitance	Cres	–	40	–	f=1MHz	
Turn-on time	ton	–	–	1.2	VCC=600V Ic=5A	µs
	tr	–	–	0.6	VGE=±15V	
Turn-off time	toff	–	–	1.5	RG=330 ohm	(Half Bridge)
	tf	–	–	0.5		

1MB05D-120 / IGBT+FWD

Item	Symbol	Characteristics			Conditions	Unit
		Min.	Typ.	Max.		
Zero gate voltage collector current	ICES	–	–	1.0	VGE=0V, VCE=1200V	mA
Gate-Emitter leakage current	IGES	–	–	20	VCE=0V, VGE=±20V	µA
Gate-Emitter threshold voltage	VGE(th)	5.5	–	8.5	VCE=20V, Ic=5mA	V
Collector-Emitter saturation voltage	VCE(sat)	–	–	3.5	VGE=15V, Ic=5A	V
Input capacitance	Cies	–	650	–	VGE=0V	pF
Output capacitance	Coes	–	150	–	VCE=10V	
Reverse transfer capacitance	Cres	–	40	–	f=1MHz	
Turn-on time	ton	–	–	1.2	VCC=600V, Ic=5A	µs
	tr	–	–	0.6	VGE=±15V	
Turn-off time	toff	–	–	1.5	RG=330 ohm	(Half Bridge)
	tf	–	–	0.5		
FWD forward on voltage	VF	–	–	3.0	IF=5A, VGE=0V	V
Reverse recovery time	trr	–	–	0.35	IF=5A, VGE=-10V, di/dt=100A/µs	µs

● Thermal resistance characteristics

1MB05-120 / IGBT

Item	Symbol	Characteristics			Conditions	Unit
		Min.	Typ.	Max.		
Thermal resistance	Rth(j-c)	–	–	1.25	IGBT	°C/W

1MB05D-120 / IGBT+FWD

Item	Symbol	Characteristics			Conditions	Unit
		Min.	Typ.	Max.		
Thermal resistance	Rth(j-c)	–	–	1.25	IGBT	°C/W
	Rth(j-c)	–	–	2.08	FWD	°C/W

■ Outline drawings, mm

1MB05-120, 1MB05D-120

TO-3P

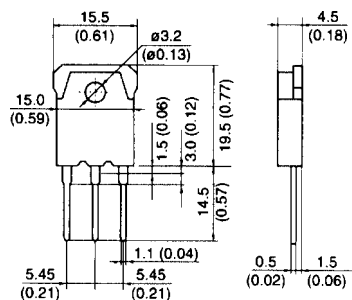

Characteristics

1MB05-120,1MB05D-120

Collector current vs. Collector-Emitter voltage

T_j=25°C

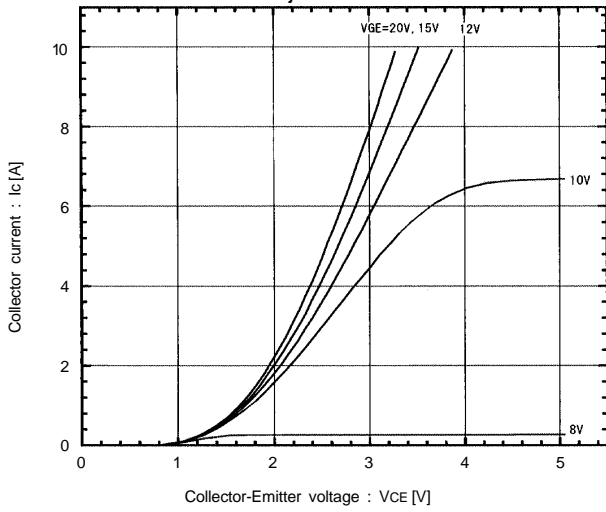

Collector current vs. Collector-Emitter voltage

T_j=125°C

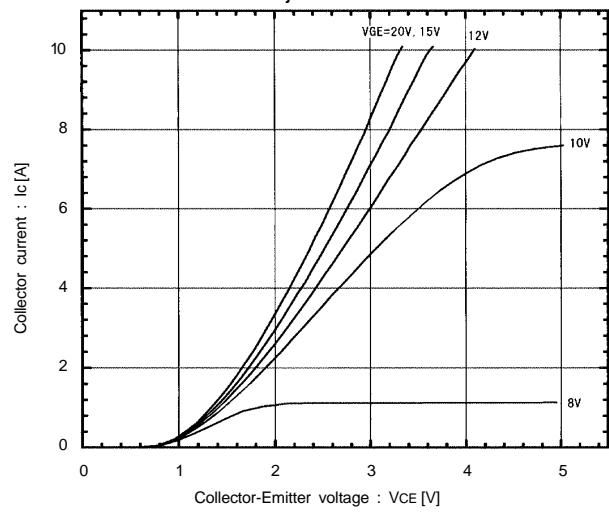

Collector-Emitter vs. Gate-Emitter voltage

T_j=25°C

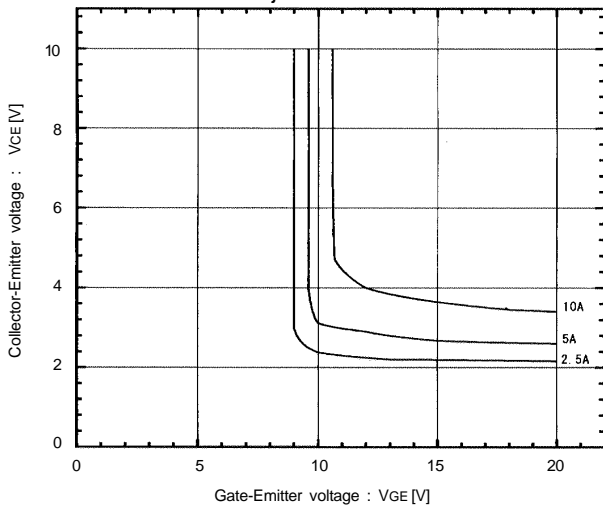

Collector-Emitter vs. Gate-Emitter voltage

T_j=125°C

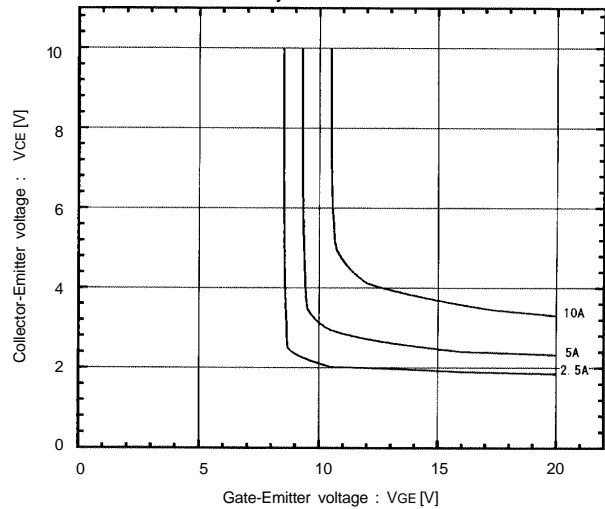

Switching time vs. Collector current

V_{CC}=600V, R_G=330 ohm, V_{GE}=±15V, T_j=25°C

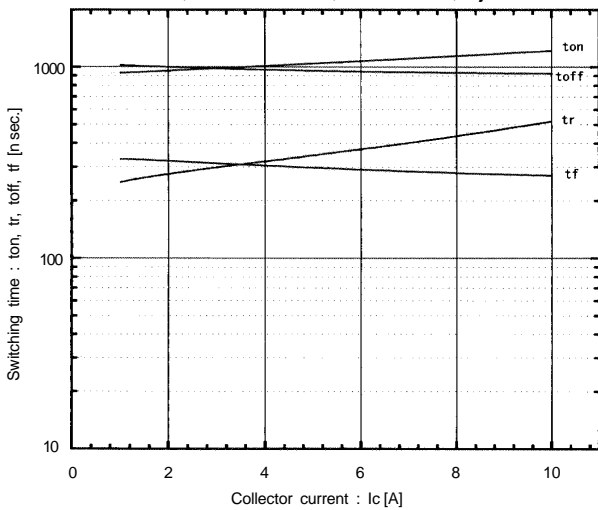

Switching time vs. Collector current

V_{CC}=600V, R_G=330 ohm, V_{GE}=±15V, T_j=125°C

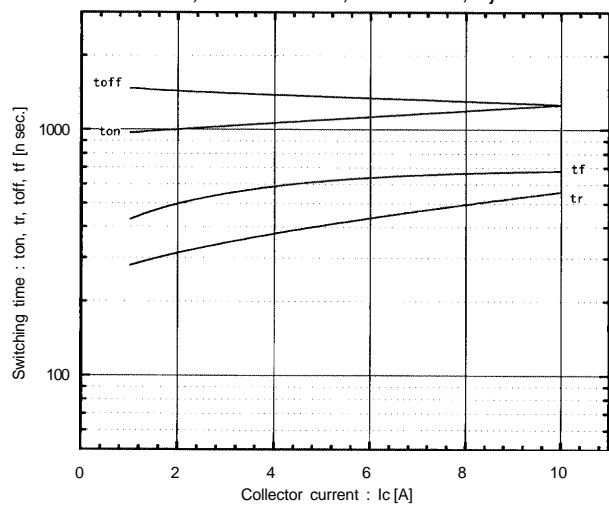

Characteristics

1MB05-120, 1MB05D-120

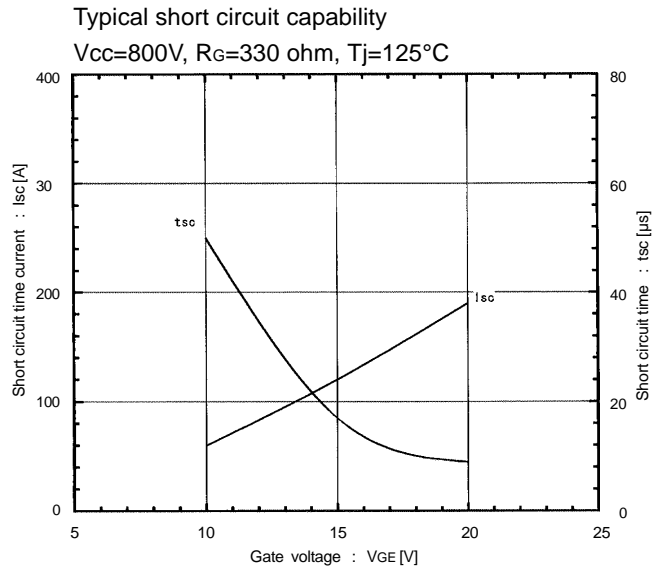
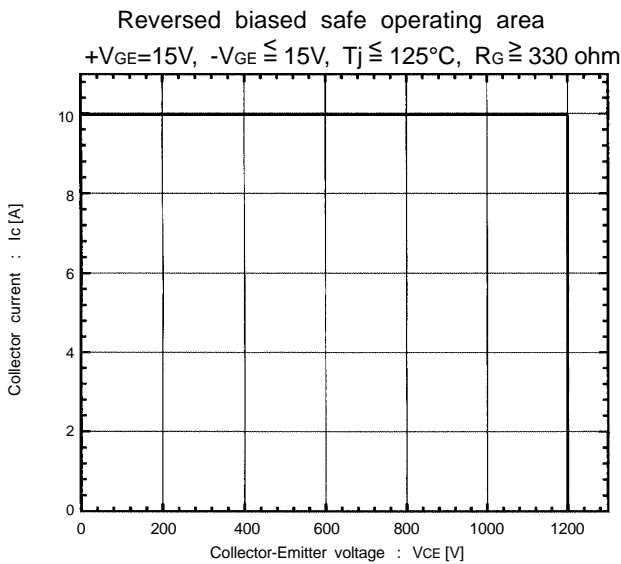
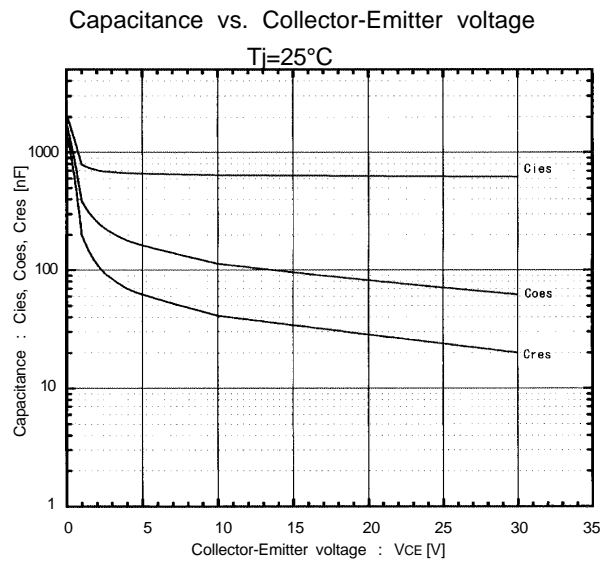
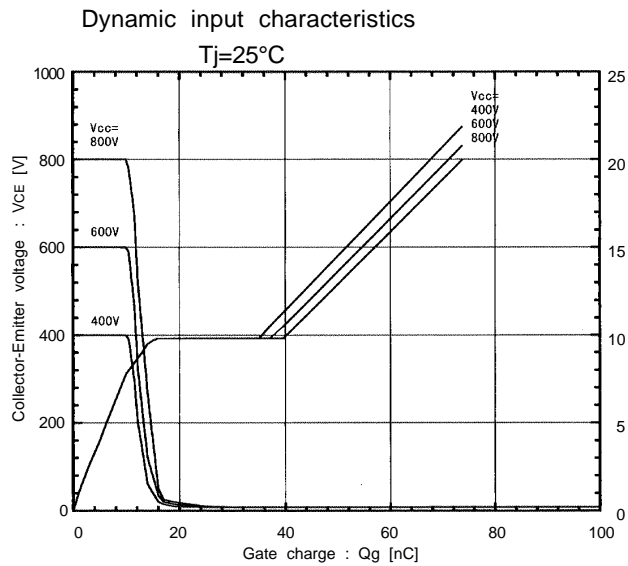
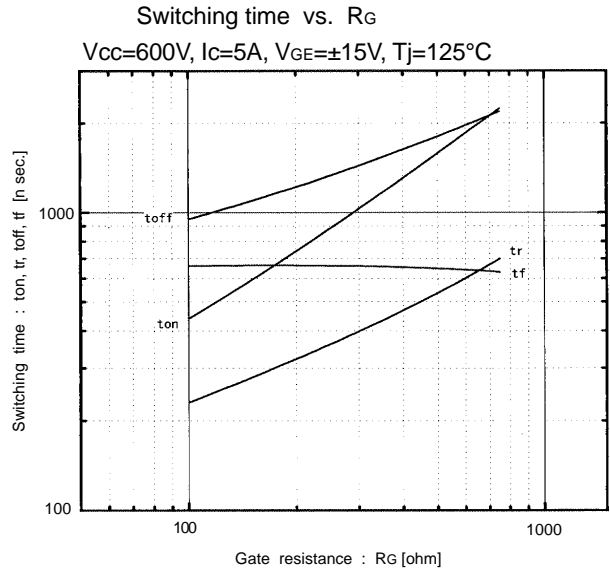
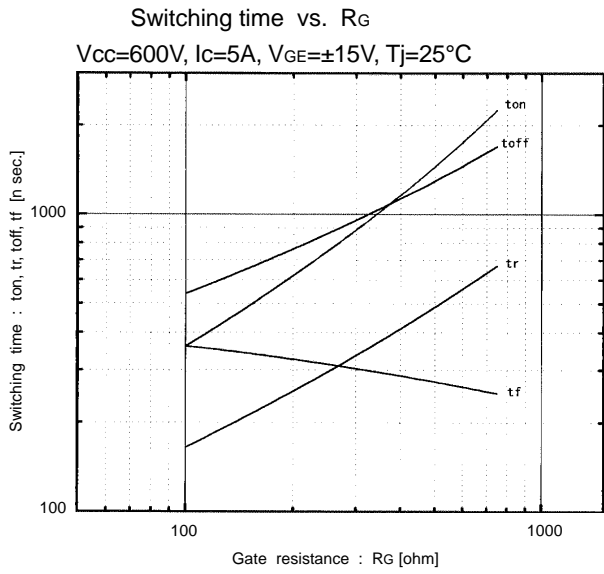

■ Characteristics

1MB05-120, 1MB05D-120

Transient thermal resistance

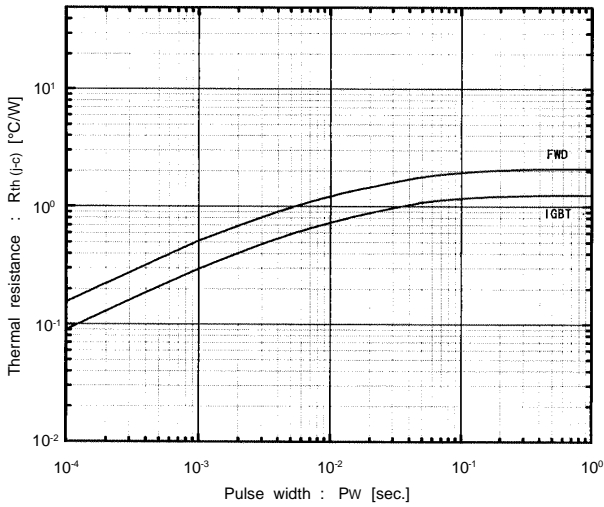

1MB05D-120

Reverse recovery time vs. Forward current
-di/dt=15A / μsec

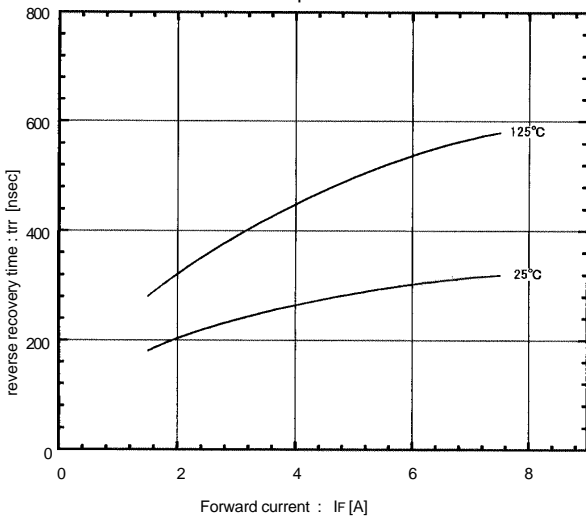

Reverse recovery current vs. Forward current
-di/dt=15A / μsec

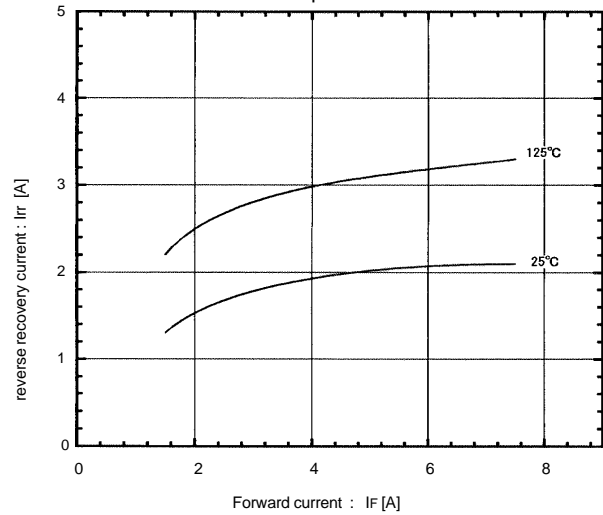

Forward current vs. Forward voltage

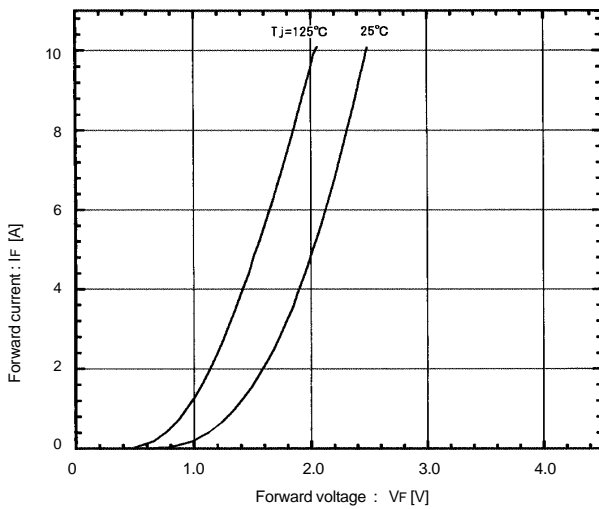

Reverse recovery time characteristics vs. -di/dt
IF=5A, Tj=125°C

