

## 1200V / 3A

## Molded Package

### ■ Features

- Small molded package
- Low power loss
- Soft switching with low switching surge and noise
- High reliability, high ruggedness (RBSOA, SCSOA etc.)
- Comprehensive line-up

### ■ Applications

- Inverter for Motor drive
- AC and DC Servo drive amplifier
- Uninterruptible power supply

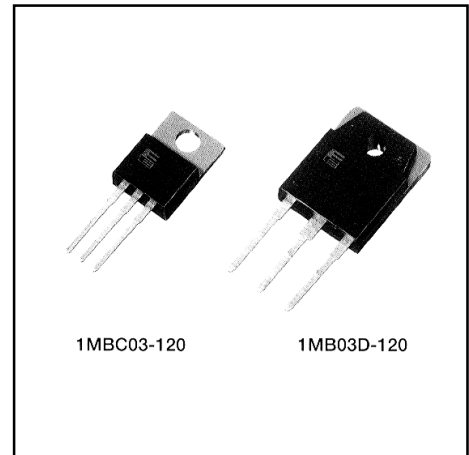

### ■ Maximum ratings and characteristics

- Absolute maximum ratings (at  $T_c=25^\circ\text{C}$  unless otherwise specified)

#### 1MBC03-120 / IGBT

Item	Symbol	Rating	Unit		
Collector-Emitter voltage	$V_{CES}$	1200	V		
Gate-Emitter voltage	$V_{GES}$	$\pm 20$	V		
Collector current	DC	$T_c=25^\circ\text{C}$	$I_{C25}$	5	A
		$T_c=100^\circ\text{C}$	$I_{C100}$	2.5	A
	1ms	$T_c=25^\circ\text{C}$	$I_{cp}$	15	A
Max. power dissipation(IGBT)	$P_c$	70	W		
Operating temperature	$T_j$	+150	$^\circ\text{C}$		
Storage temperature	$T_{stg}$	-40 to +150	$^\circ\text{C}$		
Screw torque	-	40	N·m		

#### 1MB03D-120 / IGBT+FWD

Item	Symbol	Rating	Unit		
Collector-Emitter voltage	$V_{CES}$	1200	V		
Gate-Emitter voltage	$V_{GES}$	$\pm 20$	V		
Collector current	DC	$T_c=25^\circ\text{C}$	$I_{C25}$	5	A
		$T_c=100^\circ\text{C}$	$I_{C100}$	2.5	A
	1ms	$T_c=25^\circ\text{C}$	$I_{cp}$	15	A
Max. power dissipation (IGBT)	$P_c$	70	W		
Max. power dissipation (FWD)	$P_c$	40	W		
Operating temperature	$T_j$	+150	$^\circ\text{C}$		
Storage temperature	$T_{stg}$	-40 to +150	$^\circ\text{C}$		
Screw torque	-	40	N·m		

### ■ Equivalent Circuit Schematic

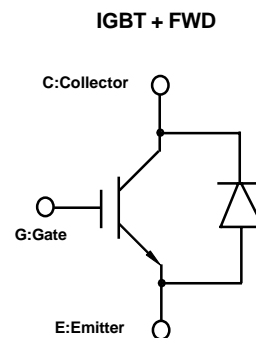
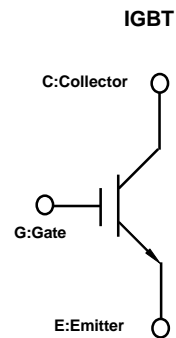

● Electrical characteristics (at Tj=25°C unless otherwise specified)

1MBC03-120 / IGBT

Item	Symbol	Characteristics			Conditions	Unit
		Min.	Typ.	Max.		
Zero gate voltage collector current	ICES	–	–	1.0	VGE=0V, VCE=1200V	mA
Gate-Emitter leakage current	IGES	–	–	20	VCE=0V, VGE=±20V	µA
Gate-Emitter threshold voltage	VGE(th)	5.5	–	8.5	VCE=20V, Ic=2.5mA	V
Collector-Emitter saturation voltage	VCE(sat)	–	–	3.5	VGE=15V, Ic=2.5A	V
Input capacitance	Cies	–	400	–	VGE=0V	pF
Output capacitance	Coes	–	70	–	VCE=10V	
Reverse transfer capacitance	Cres	–	20	–	f=1MHz	
Turn-on time	ton	–	–	1.2	VCC=600V Ic=2.5A	µs
	tr	–	–	0.6	VGE=±15V	
Turn-off time	toff	–	–	1.5	RG=430 ohm	(Half Bridge)
	tf	–	–	0.5		

1MB03D-120 / IGBT+FWD

Item	Symbol	Characteristics			Conditions	Unit
		Min.	Typ.	Max.		
Zero gate voltage collector current	ICES	–	–	1.0	VGE=0V, VCE=1200V	mA
Gate-Emitter leakage current	IGES	–	–	20	VCE=0V, VGE=±20V	µA
Gate-Emitter threshold voltage	VGE(th)	5.5	–	8.5	VCE=20V, Ic=2.5mA	V
Collector-Emitter saturation voltage	VCE(sat)	–	–	3.5	VGE=15V, Ic=2.5A	V
Input capacitance	Cies	–	400	–	VGE=0V	pF
Output capacitance	Coes	–	70	–	VCE=10V	
Reverse transfer capacitance	Cres	–	20	–	f=1MHz	
Turn-on time	ton	–	–	1.2	VCC=600V, Ic=2.5A	µs
	tr	–	–	0.6	VGE=±15V	
Turn-off time	toff	–	–	1.5	RG=430 ohm	(Half Bridge)
	tf	–	–	0.5		
FWD forward on voltage	VF	–	–	3.0	IF=2.5A, VGE=0V	V
Reverse recovery time	trr	–	–	0.35	IF=2.5A, VGE=-10V, di/dt=100A/µs	µs

● Thermal resistance characteristics

1MBC03-120 / IGBT

Item	Symbol	Characteristics			Conditions	Unit
		Min.	Typ.	Max.		
Thermal resistance	Rth(j-c)	–	–	1.78	IGBT	°C/W

1MB03D-120 / IGBT+FWD

Item	Symbol	Characteristics			Conditions	Unit
		Min.	Typ.	Max.		
Thermal resistance	Rth(j-c)	–	–	1.78	IGBT	°C/W
	Rth(j-c)	–	–	3.12	FWD	°C/W

■ Outline drawings, mm

1MBC03-120

TO-110AB

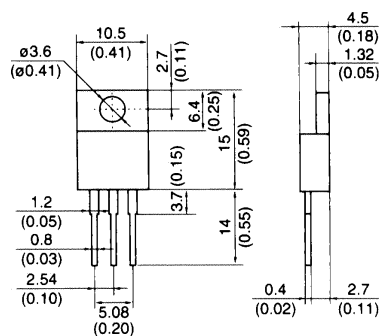

1MB03D-120

TO-3P

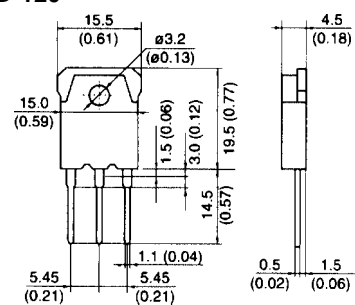

Characteristics

1MBC03-120,1MB03D-120

Collector current vs. Collector-Emitter voltage  
T<sub>j</sub>=25°C

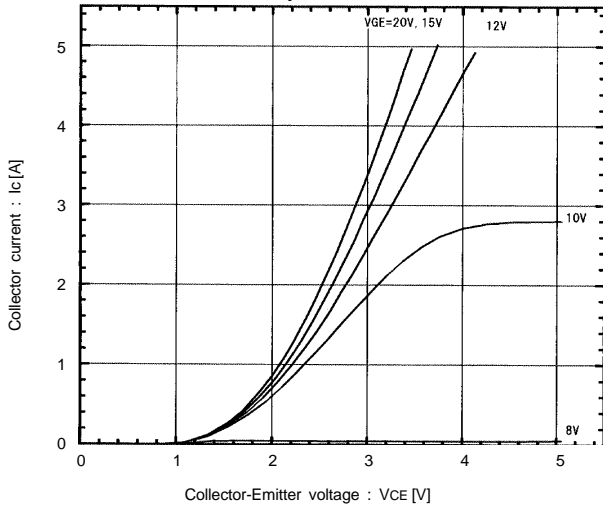

Collector current vs. Collector-Emitter voltage  
T<sub>j</sub>=125°C

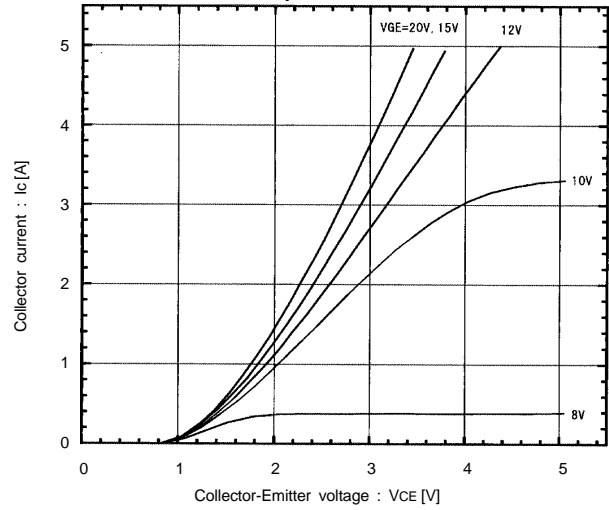

Collector-Emitter vs. Gate-Emitter voltage  
T<sub>j</sub>=25°C

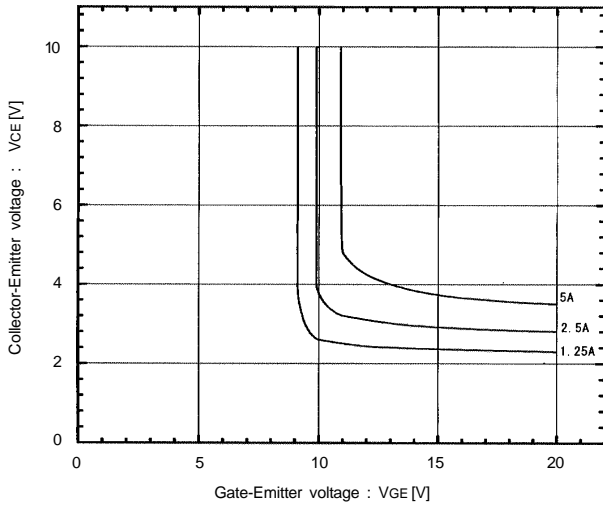

Collector-Emitter vs. Gate-Emitter voltage  
T<sub>j</sub>=125°C

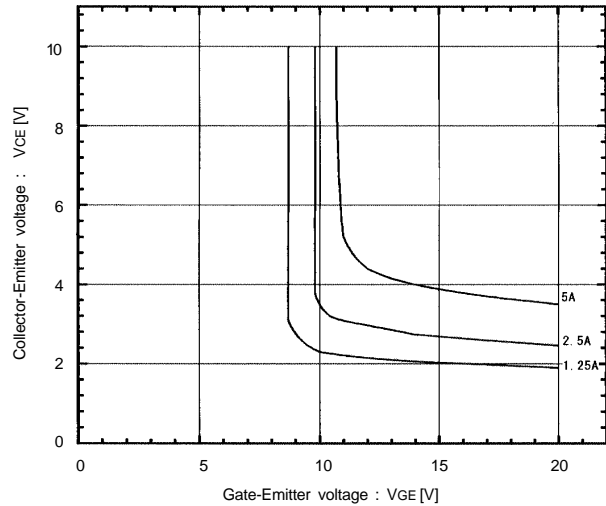

Switching time vs. Collector current  
V<sub>CC</sub>=600V, R<sub>G</sub>=430 ohm, V<sub>GE</sub>=±15V, T<sub>j</sub>=25°C

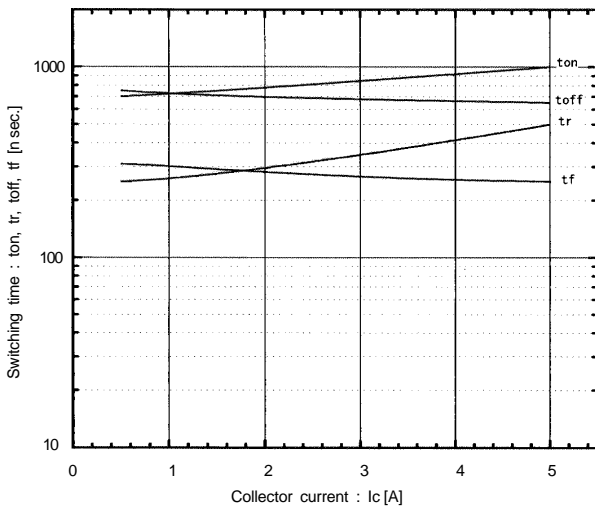

Switching time vs. Collector current  
V<sub>CC</sub>=600V, R<sub>G</sub>=430 ohm, V<sub>GE</sub>=±15V, T<sub>j</sub>=125°C

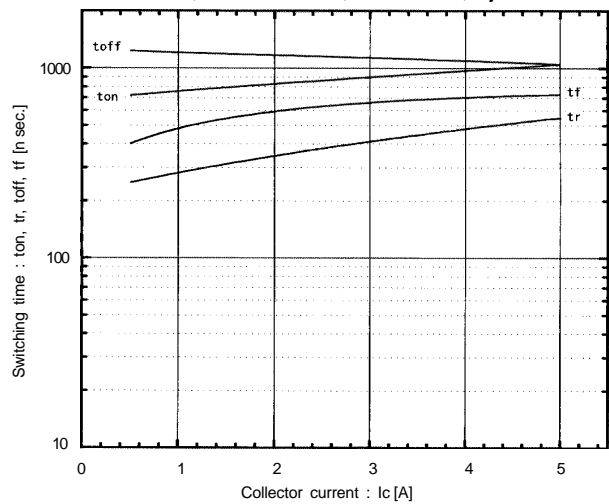

Characteristics

1MBC03-120, 1MB03D-120

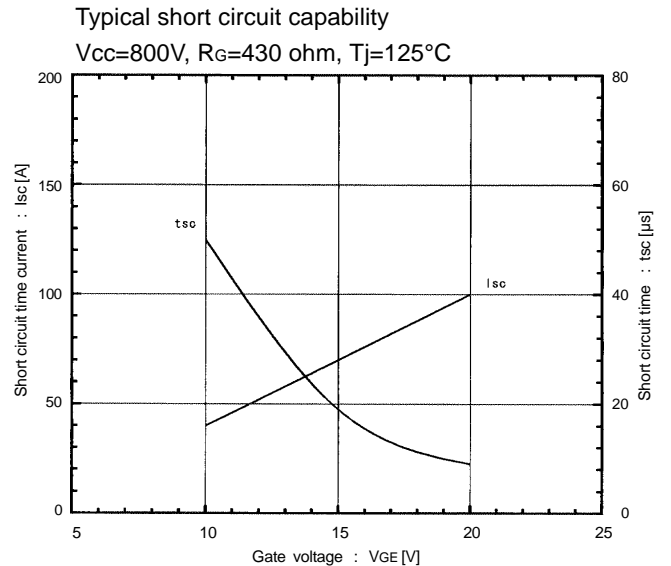
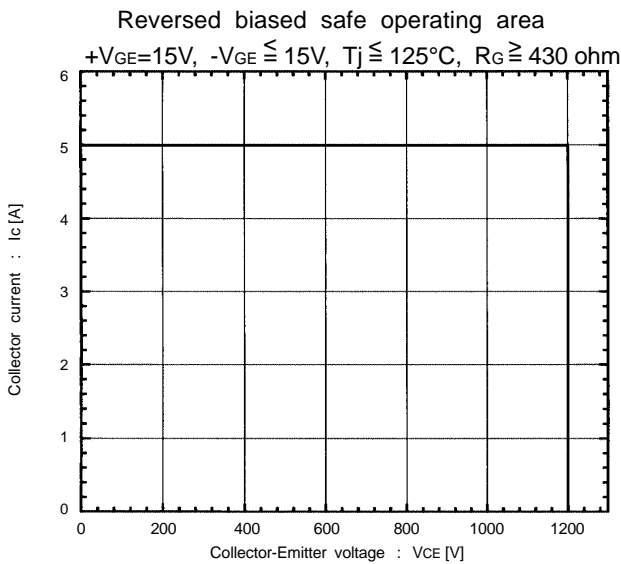
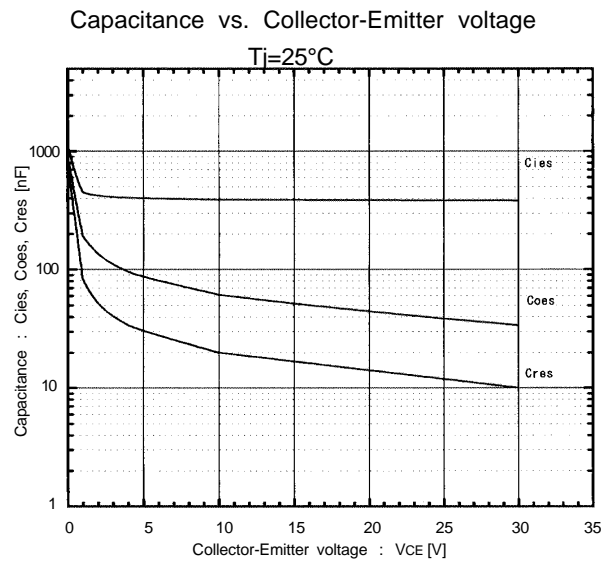
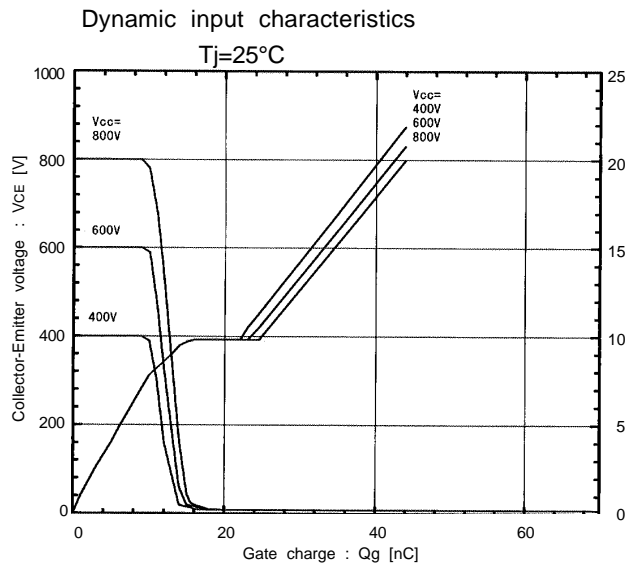
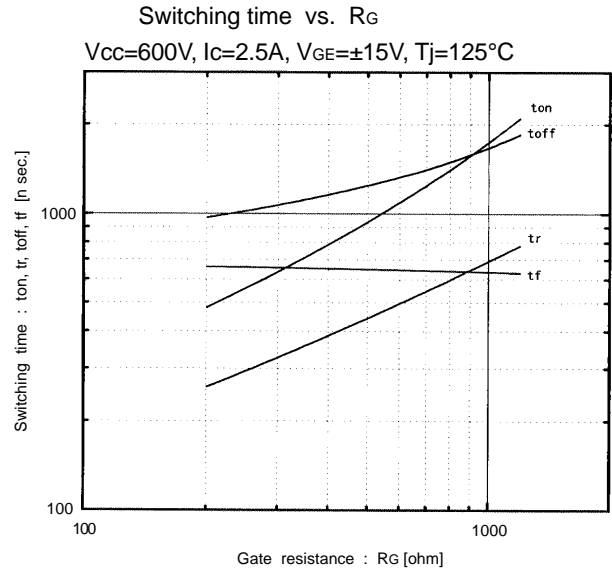
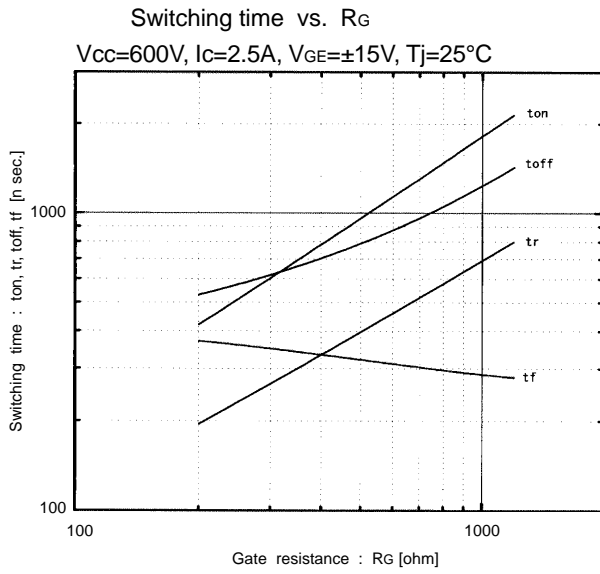

■ Characteristics

1MBC03-120, 1MB03D-120

Transient thermal resistance

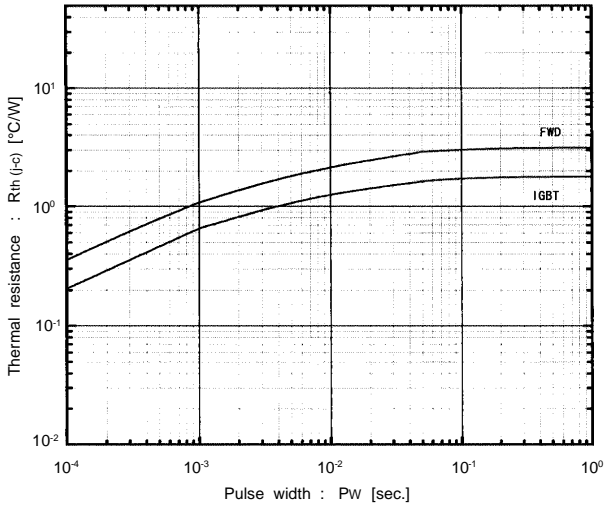

1MB03D-120

Reverse recovery time vs. Forward current

$-di/dt=7.5A/\mu sec$

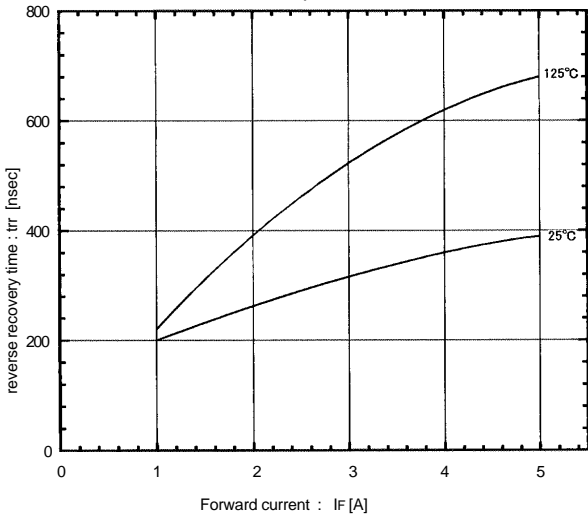

Reverse recovery current vs. Forward current

$-di/dt=7.5A/\mu sec$

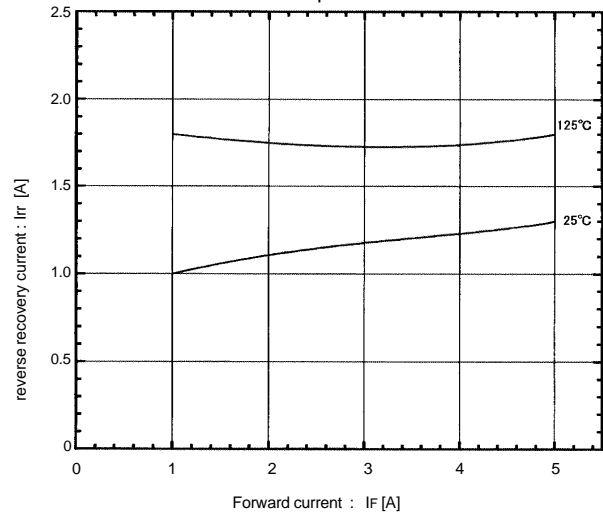

Forward current vs. Forward voltage

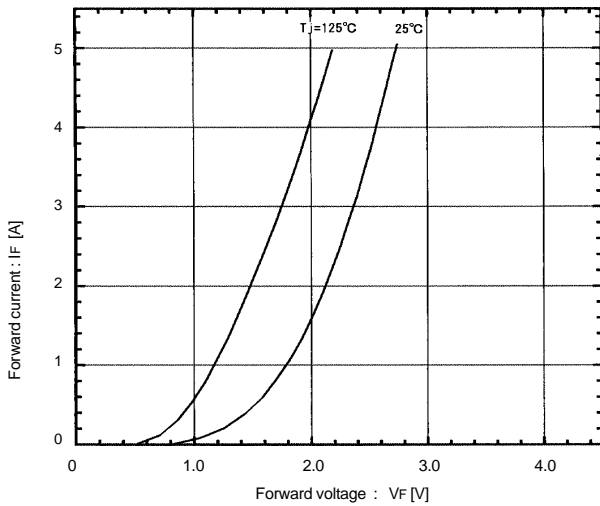

Reverse recovery time characteristics vs.  $-di/dt$

$I_F=2.5A, T_j=125^{\circ}C$

