

# 1MBH15D-060

Molded IGBT

## 600V / 15A Molded Package

■ Outline drawings, mm TO-3PL

### ■ Features

- Small molded package
- Low power loss
- Soft switching with low switching surge and noise
- High reliability, high ruggedness (RBSOA, SCSOA etc.)
- Comprehensive line-up

### ■ Applications

- Inverter for Motor drive
- AC and DC Servo drive amplifier
- Uninterruptible power supply

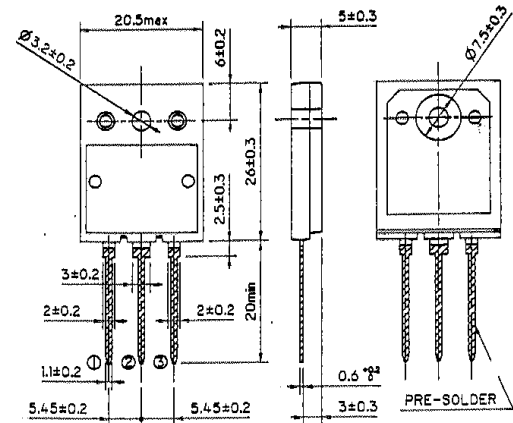

CONNECTION

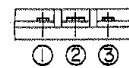

- ① GATE
- ② COLLECTOR
- ③ EMITTER

### ■ Maximum ratings and characteristics

#### ● Absolute maximum ratings (Tc=25°C)

Item	Symbol	Rating	Unit		
Collector-Emitter voltage	V <sub>CEs</sub>	600	V		
Gate-Emitter voltage	V <sub>GES</sub>	±20	V		
Collector current	DC	T <sub>c</sub> =25°C	I <sub>c25</sub>	37	A
		T <sub>c</sub> =110°C	I <sub>c110</sub>	15	A
	1ms	T <sub>c</sub> =25°C	I <sub>cp</sub>	132	A
Max. power dissipation (IGBT)	P <sub>c</sub>	140	W		
Max. power dissipation (FWD)	P <sub>c</sub>	75	W		
Operating temperature	T <sub>j</sub>	+150	°C		
Storage temperature	T <sub>stg</sub>	-40 to +150	°C		
Screw torque	-	70	N·m		

### ■ Equivalent Circuit Schematic

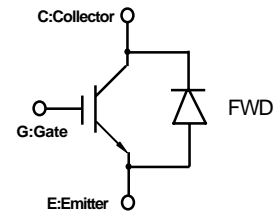

#### ● Electrical characteristics (at Tc=25°C unless otherwise specified)

Item	Symbol	Characteristics			Conditions	Unit		
		Min.	Typ.	Max.				
Zero gate voltage collector current	I <sub>CEs</sub>	-	-	1.0	V <sub>GE</sub> =0V, V <sub>CE</sub> =600V	mA		
Gate-Emitter leakage current	I <sub>GES</sub>	-	-	20	V <sub>CE</sub> =0V, V <sub>GE</sub> =±20V	µA		
Gate-Emitter threshold voltage	V <sub>GE(th)</sub>	5.5	-	8.5	V <sub>CE</sub> =20V, I <sub>c</sub> =15mA	V		
Collector-Emitter saturation voltage	V <sub>CE(sat)</sub>	-	-	3.0	V <sub>GE</sub> =15V, I <sub>c</sub> =15A	V		
Input capacitance	C <sub>ies</sub>	-	1000	-	V <sub>GE</sub> =0V	pF		
Output capacitance	C <sub>oes</sub>	-	200	-	V <sub>CE</sub> =10V			
Reverse transfer capacitance	C <sub>res</sub>	-	40	-	f=1MHz			
Switching Time	Turn-on time	t <sub>on</sub>	-	-	1.2	V <sub>CC</sub> =300V, I <sub>c</sub> =15A	µs	
		t <sub>r</sub>	-	-	0.6	V <sub>GE</sub> =±15V		
	Turn-off time	t <sub>off</sub>	-	-	1.0	R <sub>G</sub> =160 ohm		
		t <sub>f</sub>	-	-	0.35	(Half Bridge)		
	Turn-on time	t <sub>on</sub>	-	0.16	-	V <sub>CC</sub> =300V, I <sub>c</sub> =15A		µs
		t <sub>r</sub>	-	0.11	-	V <sub>GE</sub> =+15V		
Turn-off time	t <sub>off</sub>	-	0.30	-	R <sub>G</sub> =16 ohm			
	t <sub>f</sub>	-	-	0.35	(Half Bridge)			
FWD forward on voltage	V <sub>F</sub>	-	-	3.0	I <sub>F</sub> =15A	V		
Reverse recovery time	t <sub>rr</sub>	-	-	0.3	I <sub>F</sub> =15A, V <sub>GE</sub> =-10V, V <sub>R</sub> =200V, di/dt=100A/µs	µs		

#### ● Thermal resistance characteristics

Item	Symbol	Characteristics			Conditions	Unit
		Min.	Typ.	Max.		
Thermal resistance	R <sub>th(j-c)</sub>	-	-	0.89	IGBT	°C/W
	R <sub>th(j-c)</sub>	-	-	1.66	FWD	°C/W

Characteristics

Collector current vs. Collector-Emitter voltage  
T<sub>j</sub>=25°C

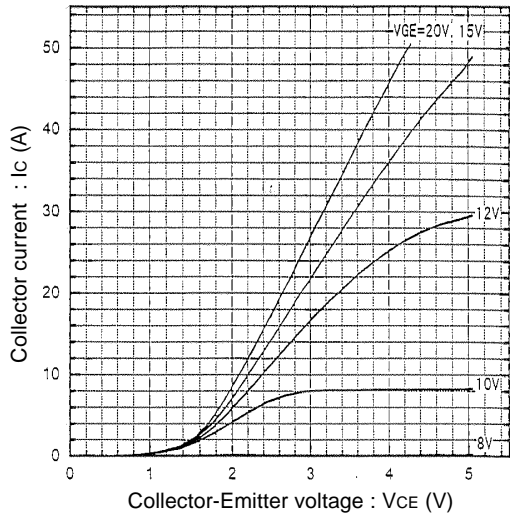

Collector current vs. Collector-Emitter voltage  
T<sub>j</sub>=125°C

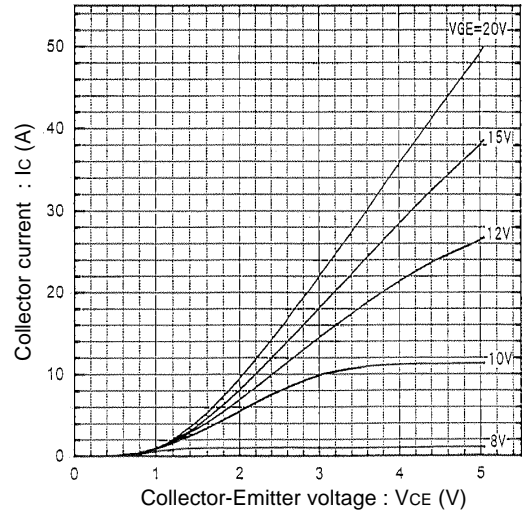

Collector-Emitter voltage vs. Gate-Emitter voltage  
T<sub>j</sub>=25°C

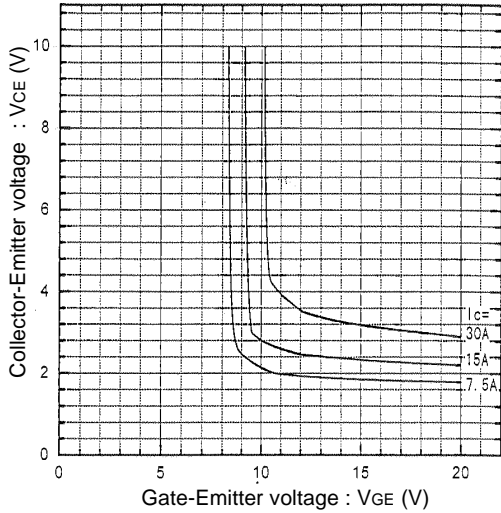

Collector-Emitter voltage vs. Gate-Emitter voltage  
T<sub>j</sub>=125°C

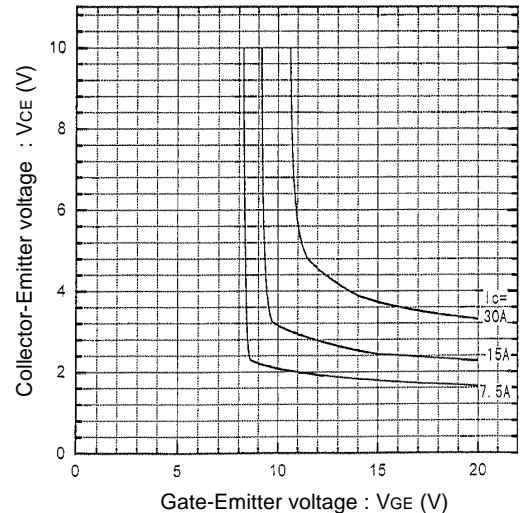

Switching time vs. Collector current  
V<sub>CC</sub>=300V, R<sub>G</sub>=16Ω, V<sub>GE</sub>=±15V, T<sub>j</sub>=25°C

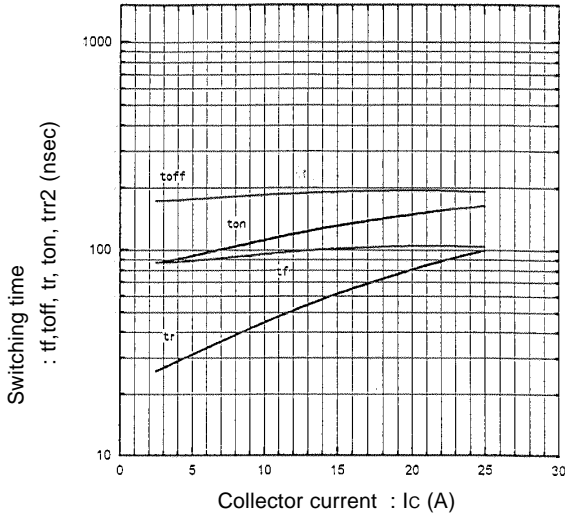

Switching time vs. Collector current  
V<sub>CC</sub>=300V, R<sub>G</sub>=16Ω, V<sub>GE</sub>=±15V, T<sub>j</sub>=125°C

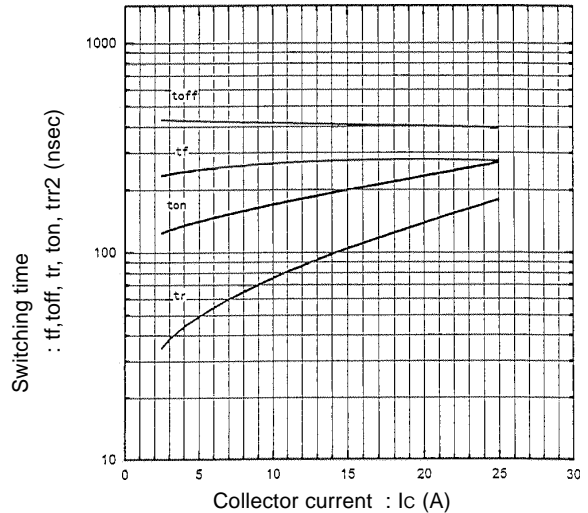

Characteristics

Switching time vs.  $R_G$   
 $V_{CC}=300V, I_C=15A, V_{GE}=\pm 15V, T_J=25^\circ C$

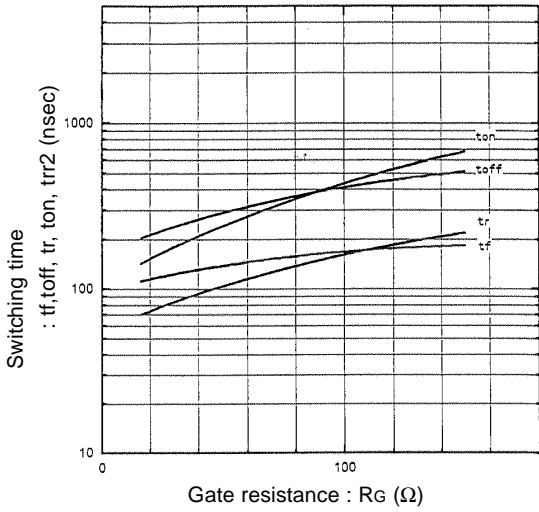

Switching time vs.  $R_G$   
 $V_{CC}=300V, I_C=15A, V_{GE}=\pm 15V, T_J=125^\circ C$

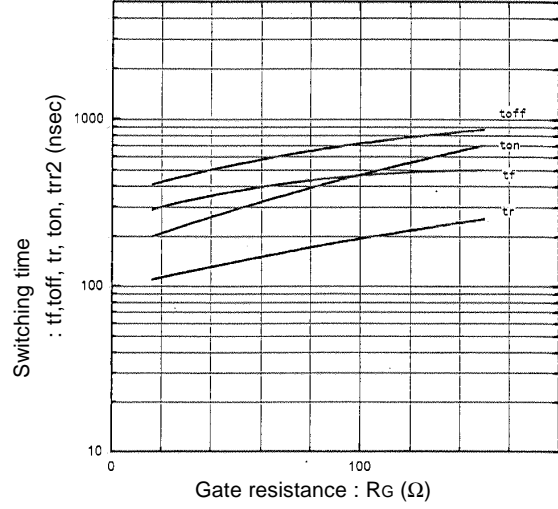

Dynamic input characteristics  
 $T_J=25^\circ C$

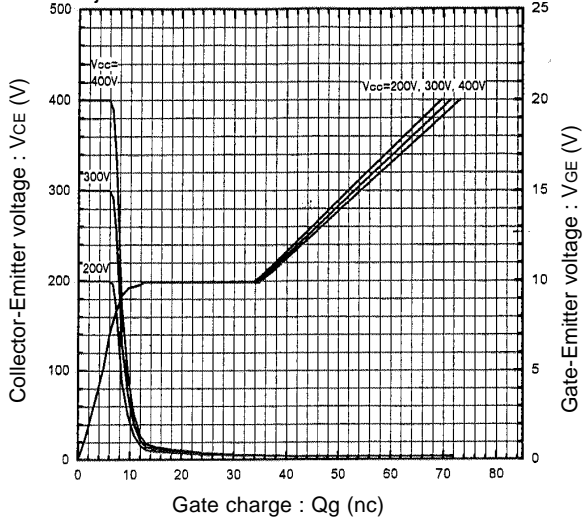

Capacitance vs. Collector-Emitter voltage  
 $T_J=25^\circ C$

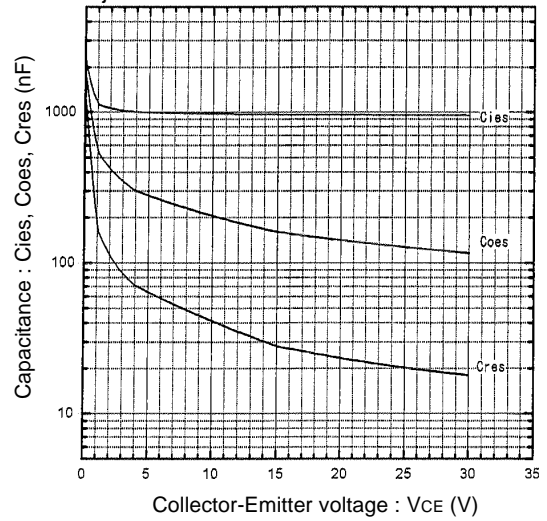

Reverse Biased Safe Operating Area  
 $+V_{GE}=15V, -V_{GE}\le 15V, T_J\le 125^\circ C, R_G\ge 16\Omega$

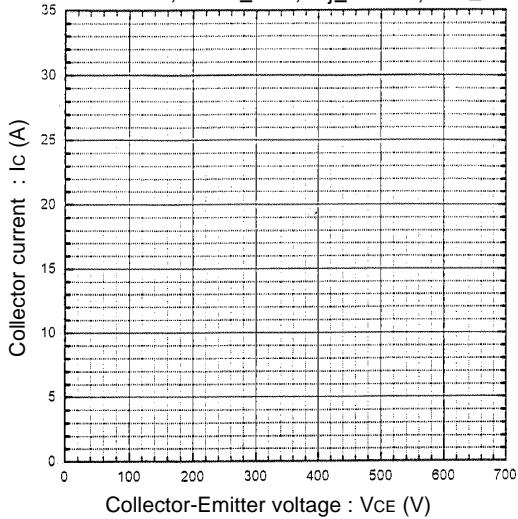

Typical short circuit capability  
 $V_{CC}=400V, R_G=16\Omega, T_J=125^\circ C,$

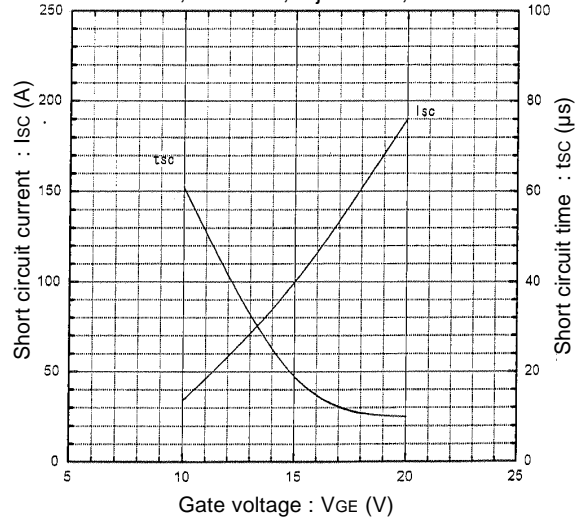

■ Characteristics

Reverse recovery time vs. Forward current  
VR=200V, -di/dt=100A/μsec

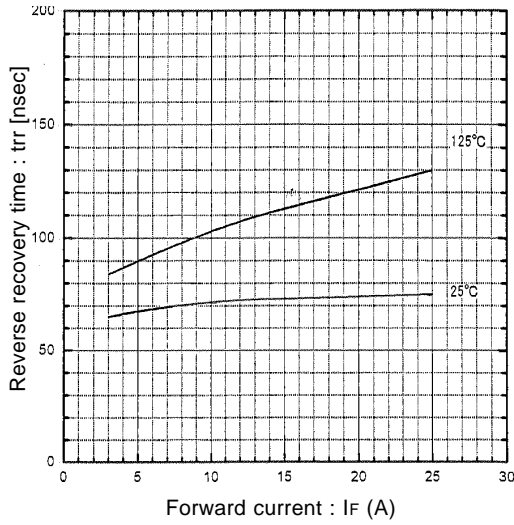

Reverse recovery current vs. Forward current  
VR=200V, -di/dt=100A/μsec

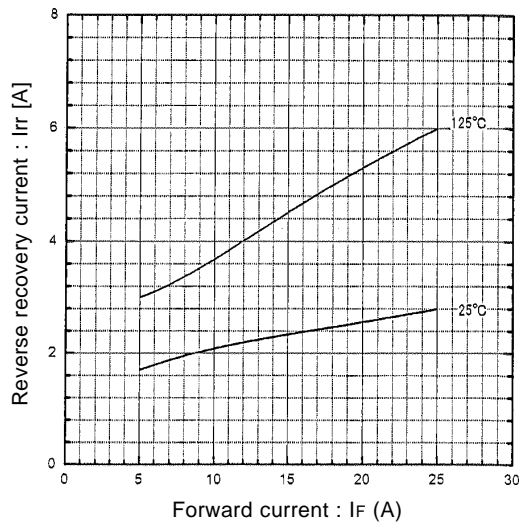

Forward voltage vs. Forward current

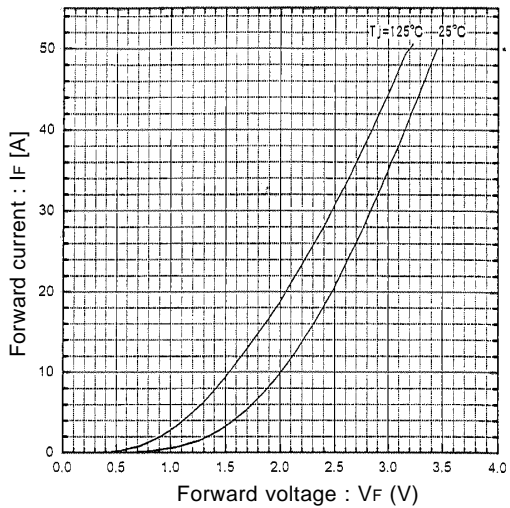

Reverse recovery characteristics vs. -di/dt  
IF=15A, Tj=125°C

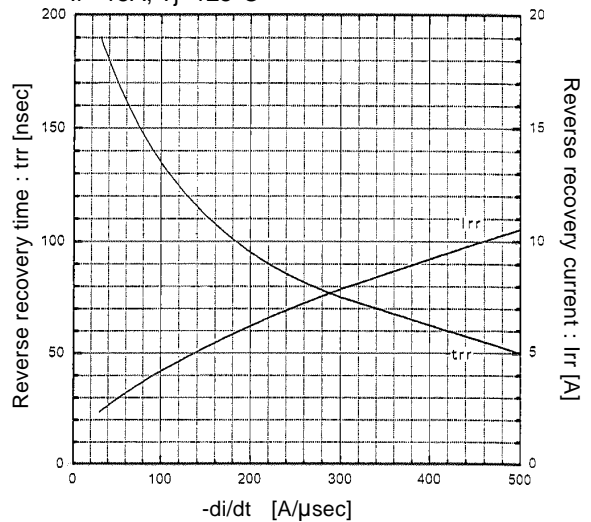

Transient thermal resistance

