

1MBI2400VR-170E

IGBT Modules

IGBT MODULE (V series) 1700V / 2400A / 1 in one package

■ Features

- High speed switching
- Voltage drive
- Low Inductance module structure

■ Applications

- Inverter for Motor Drive
- AC and DC Servo Drive Amplifier
- Uninterruptible Power Supply
- Industrial machines, such as Welding machines



■ Maximum Ratings and Characteristics

● Absolute Maximum Ratings (at Tc=25°C unless otherwise specified)

Items	Symbols	Conditions	Maximum ratings	Units	
Collector-Emitter voltage	V_{CES}		1700	V	
Gate-Emitter voltage	V_{GES}		±20	V	
Collector current	I_c	Continuous	Tc=25°C	3600	A
			Tc=100°C	2400	
	I_{cp}	1ms	4800		
	$-I_c$		2400		
	$-I_{c\ pulse}$	1ms	4800		
Collector power dissipation	P_c	1 device	14010	W	
Junction temperature	T_j		175	°C	
Operating junction temperature (under switching conditions)	T_{jop}		150		
Storage temperature	T_{stg}		-40 ~ +125		
Isolation voltage	Between terminal and copper base (*1) V_{iso}	AC : 1min.	4000	VAC	
Screw torque (*2)	Mounting	M6	5.75	Nm	
	Main Terminals	M8	10		
	Sense Terminals	M4	2.5		

Note *1: All terminals should be connected together when isolation test will be done.

Note *2: Recommendable Value :

Mounting 4.25~5.75 Nm (M6) , Main Terminals 8~10 Nm (M8) , Sense Terminals 1.7~2.5 Nm (M4)

● Electrical characteristics (at Tj= 25°C unless otherwise specified)

Items	Symbols	Conditions	Characteristics			Units	
			min.	typ.	max.		
Zero gate voltage collector current	I_{CES}	$V_{GE} = 0V, V_{CE} = 1700V$	-	-	1.0	mA	
Gate-Emitter leakage current	I_{GES}	$V_{CE} = 0V, V_{GE} = \pm 20V$	-	-	3200	nA	
Gate-Emitter threshold voltage	$V_{GE(th)}$	$V_{CE} = 20V, I_c = 2400mA$	6.0	6.5	7.0	V	
Collector-Emitter saturation voltage	$V_{CE(sat)}$ (main terminal)	$V_{GE} = 15V$ $I_c = 2400A$	$T_j = 25^\circ C$	-	2.32	2.61	V
			$T_j = 125^\circ C$	-	2.72	-	
			$T_j = 150^\circ C$	-	2.77	-	
	$V_{CE(sat)}$ (chip)		$T_j = 25^\circ C$	-	2.00	2.25	
			$T_j = 125^\circ C$	-	2.40	-	
			$T_j = 150^\circ C$	-	2.45	-	
Internal gate resistance	Int Rg		-	0.94	-	Ω	
Input capacitance	C_{ies}	$V_{CE} = 10V, V_{GE} = 0V, f = 1MHz$	-	218	-	nF	
Turn-on	t_{on}	$V_{CC} = 900V, I_c = 2400A$ $L_m = 56nH, V_{GE} = \pm 15V, T_j = 125^\circ C$	-	2.51	-	μs	
	t_r		-	0.90	-		
Turn-off	t_{off}	$R_{gon} = 0.56 \Omega$	-	2.41	-		
	t_f	$R_{goff} = 0.39 \Omega$	-	0.38	-		
Forward on voltage	V_F (main terminal)	$V_{GE} = 0V$ $I_F = 2400A$	$T_j = 25^\circ C$	-	1.98	2.34	V
			$T_j = 125^\circ C$	-	2.14	-	
			$T_j = 150^\circ C$	-	2.11	-	
	V_F (chip)		$T_j = 25^\circ C$	-	1.66	1.98	
			$T_j = 125^\circ C$	-	1.82	-	
			$T_j = 150^\circ C$	-	1.79	-	
Reverse recovery	t_{rr}	$I_F = 2400A, T_j = 125^\circ C$	-	0.63	-	μs	
Lead resistance, terminal-chip	R lead		-	0.134	-	m Ω	

● Thermal resistance characteristics

Items	Symbols	Conditions	Characteristics			Units
			min.	typ.	max.	
Thermal resistance	$R_{th(j-c)}$	IGBT	-	-	0.0107	$^\circ C/W$
		FWD	-	-	0.0147	
Contact thermal resistance (*3)	$R_{th(c-f)}$	with Thermal Compound	-	0.0077	-	

Note *3: This is the value which is defined mounting on the additional cooling fin with thermal compound.

■ Characteristics (Representative)

Collector current vs. Collector-Emittor voltage (typ.)
T_j=25°C, chip

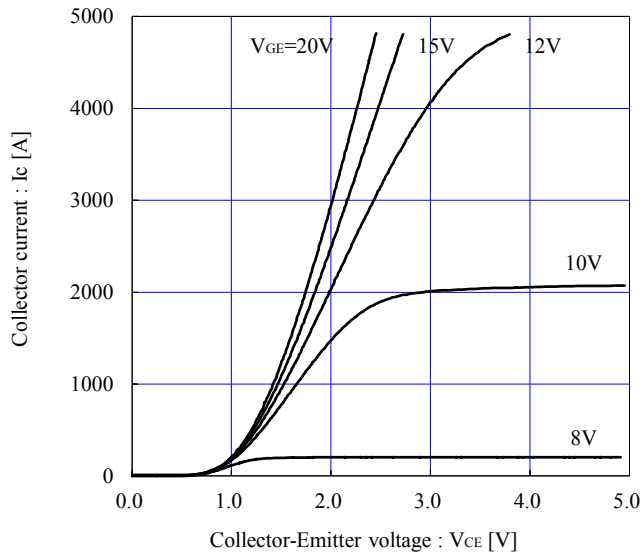

Collector current vs. Collector-Emittor voltage (typ.)
T_j= 150°C, chip

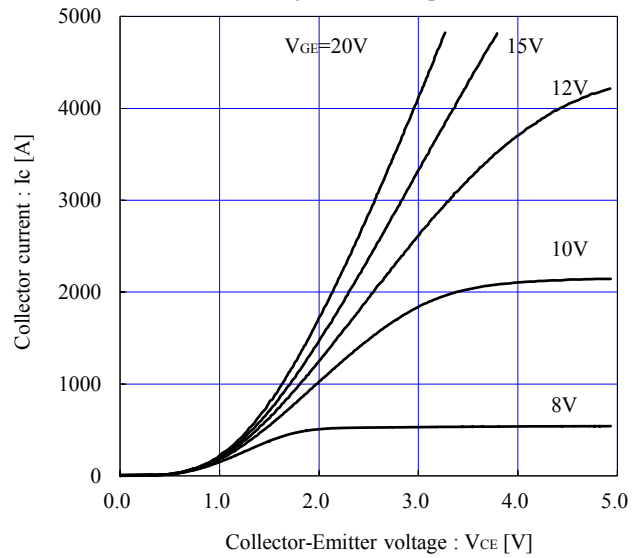

Collector current vs. Collector-Emittor voltage (typ.)
V_{GE}=+15V, chip

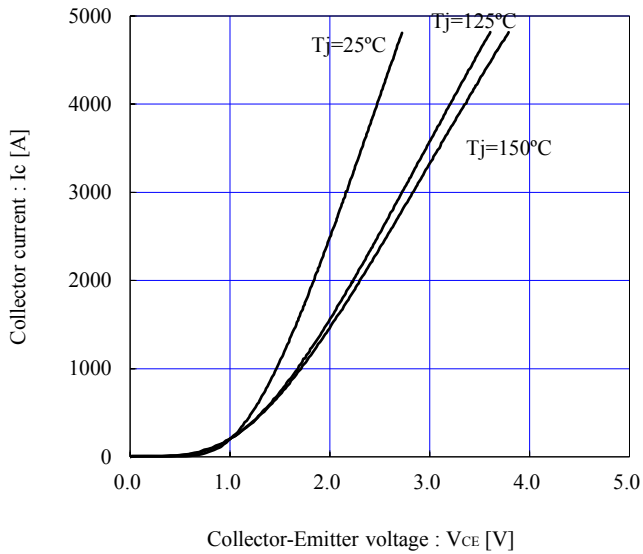

Collector-Emittor voltage vs. Gate-Emittor voltage (typ.)
T_j=25°C, chip

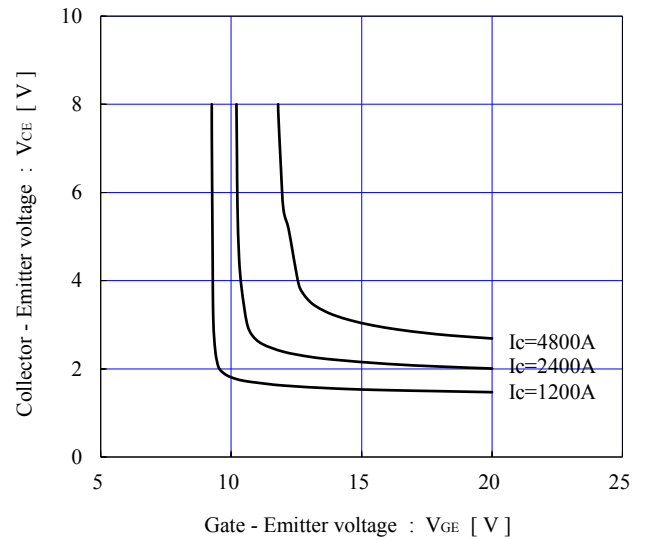

Capacitance vs. Collector-Emittor voltage (typ.)
V_{GE}=0V, f= 1MHz, T_j= 25°C

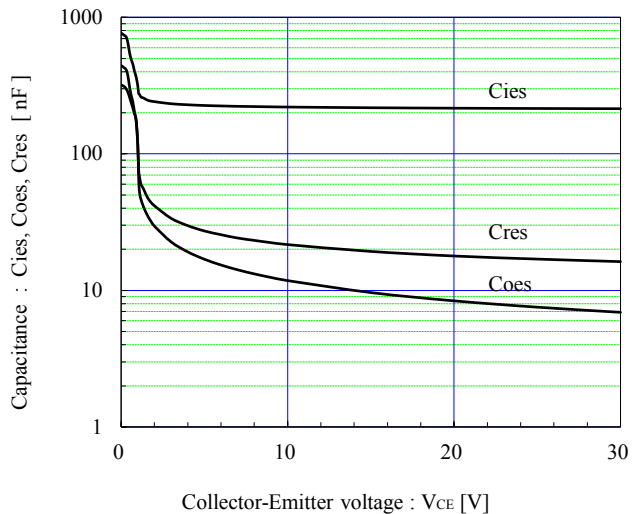

Dynamic Gate charge (typ.)
T_j= 25°C

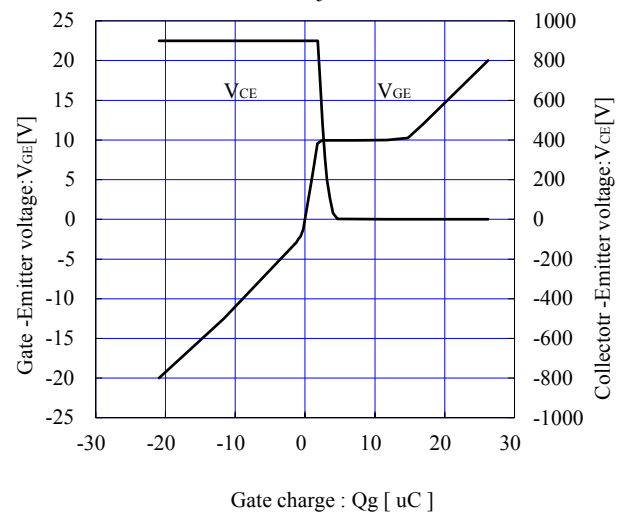

Switching time vs. Collector current (typ.)

V_{cc}=900V, V_{GE}=±15V, R_{gon}=0.56Ω, R_{goff}=0.39Ω

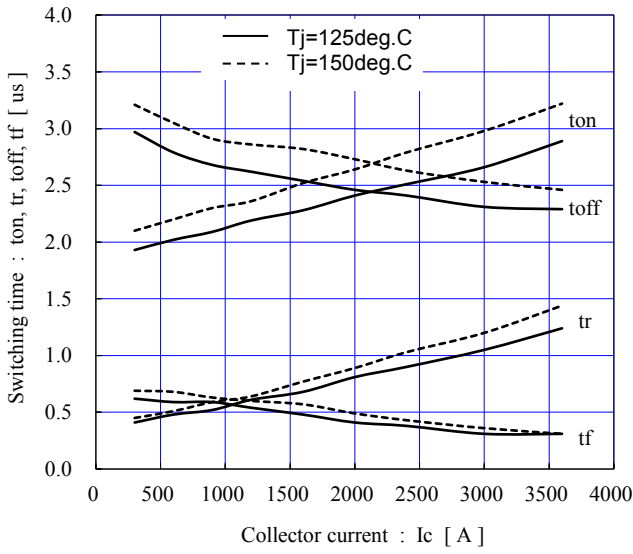

Switching time vs. Gate resistance (typ.)

V_{cc}=900V, I_c=2400A, V_{GE}=±15V

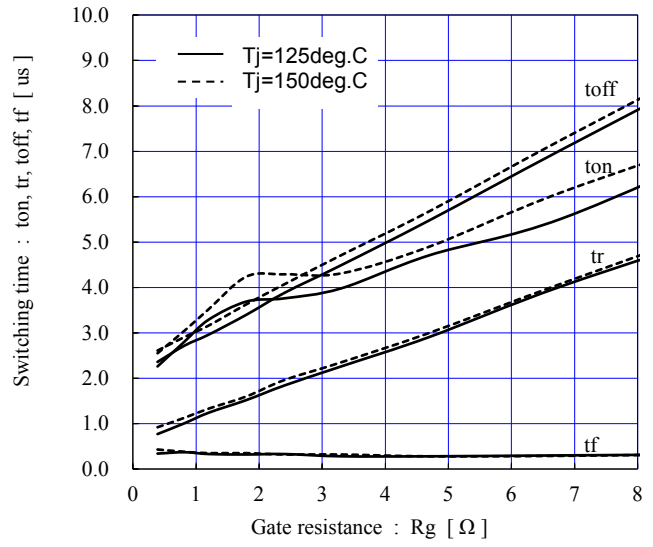

Switching loss vs. Collector current (typ.)

V_{cc}=900V, V_{GE}=±15V, R_{gon}=0.56Ω, R_{goff}=0.39Ω

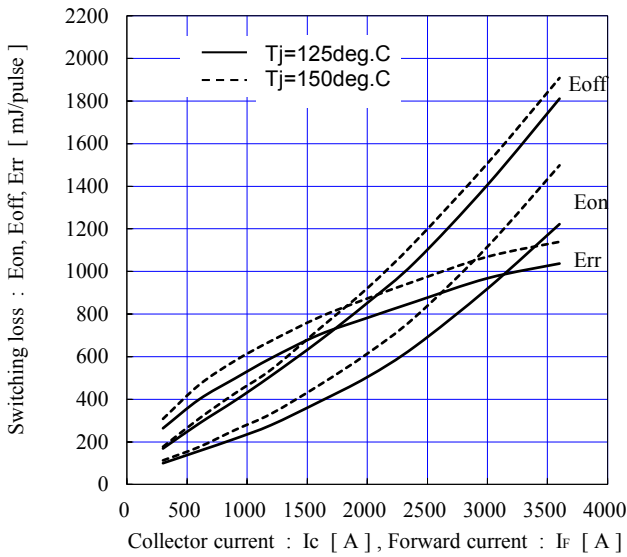

Switching loss vs. Gate resistance (typ.)

V_{cc}=900V, I_c=2400A, V_{GE}=±15V

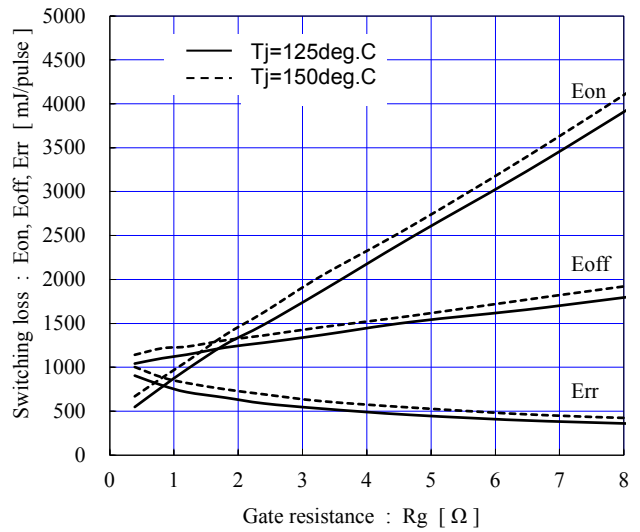

Reverse bias safe operating area (max.)

±V_{GE}=15V, T_j = 150°C / chip

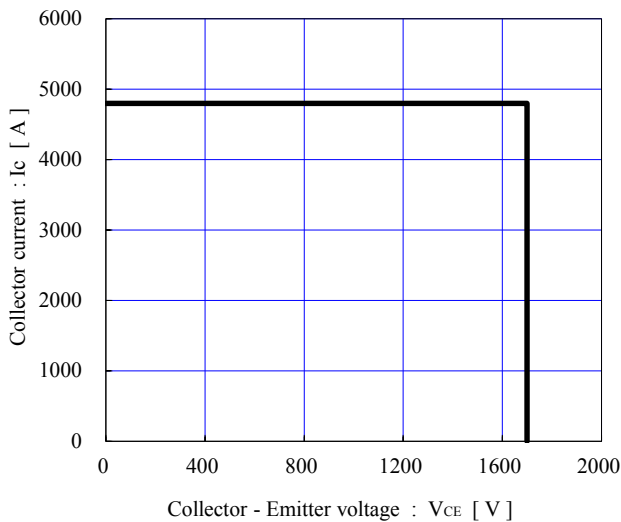

Forward current vs. Forward on voltage (typ.)
chip

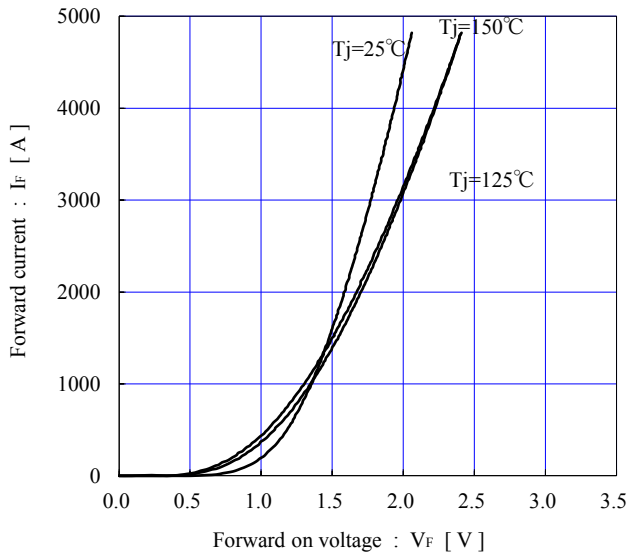

Reverse recovery characteristics (typ.)
V_{cc}=900V, V_{GE}=±15V, R_{gon}=0.56Ω

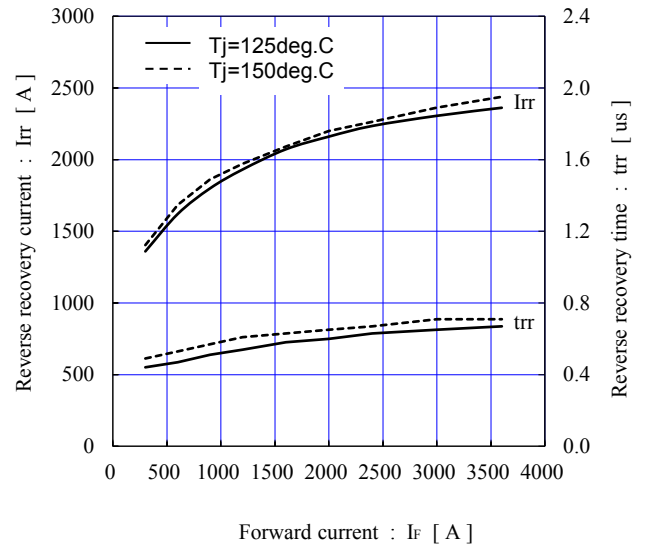

FWD safe operating area (max.)
T_j=150°C / sence terminals

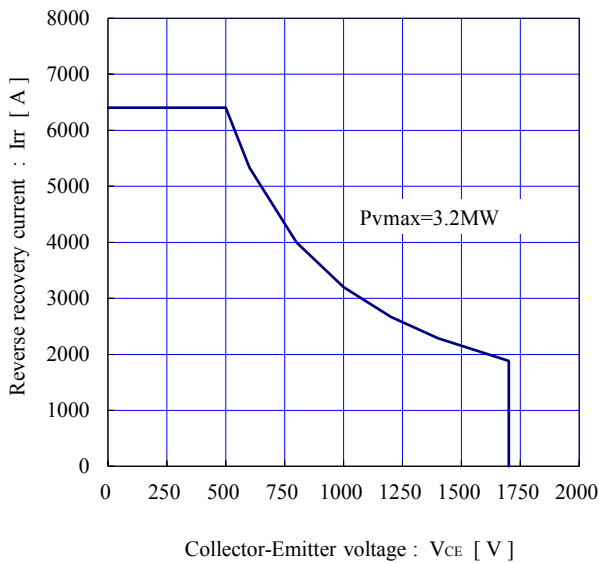

Transient thermal resistance (max.)

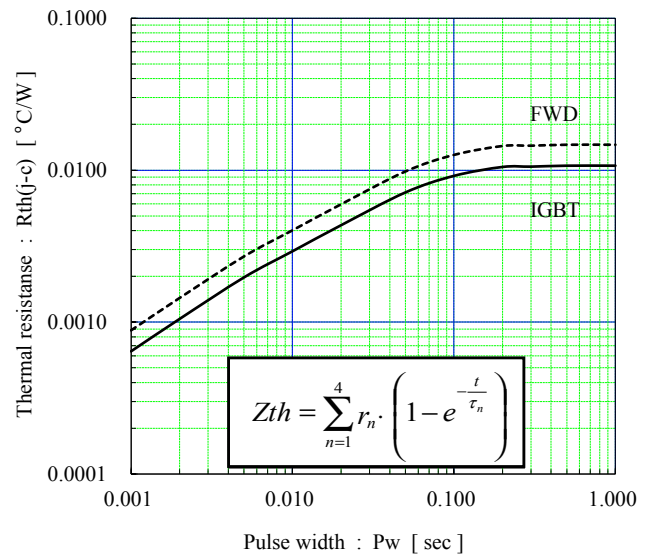

	IGBT	FWD
r1	0.00120	0.00164
r2	0.00413	0.00568
r3	0.00296	0.00407
r4	0.00241	0.00331
τ1	0.0024	0.0024
τ2	0.0359	0.0357
τ3	0.0627	0.0633
τ4	0.0743	0.0738

■ Outline Drawings, mm

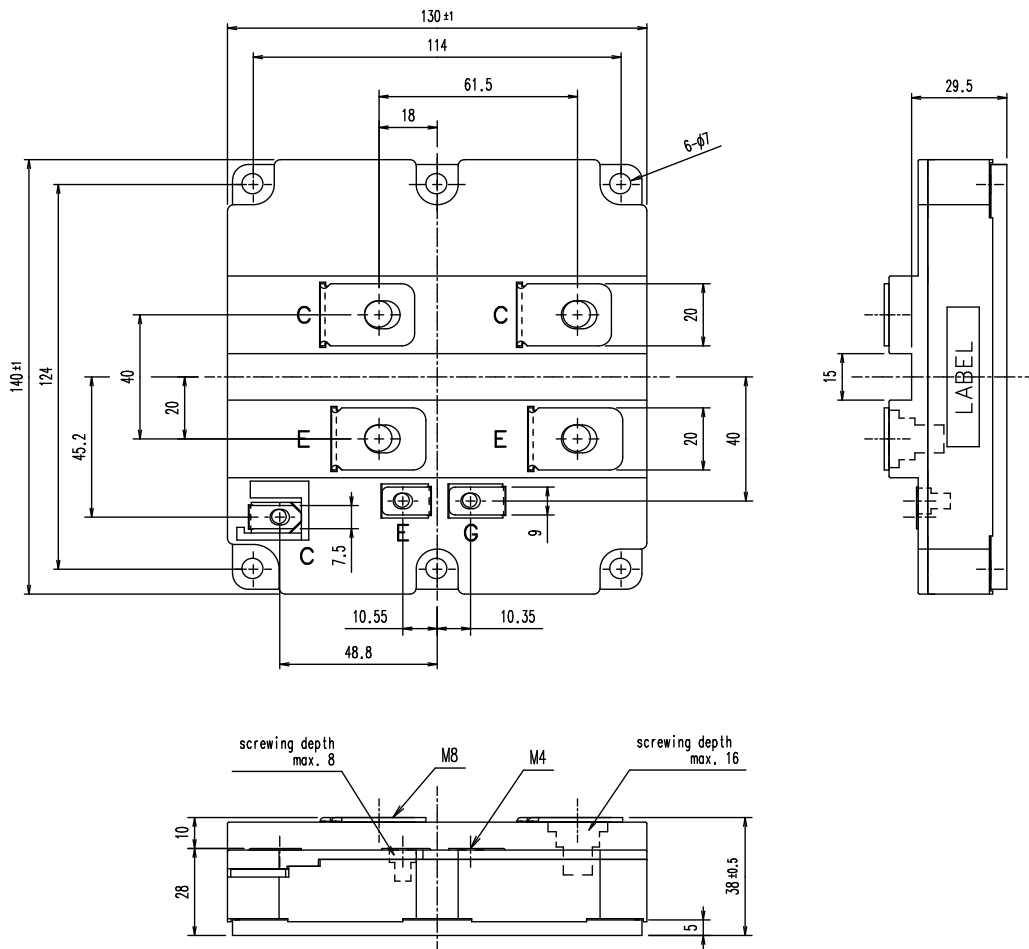

■ Equivalent Circuit Schematic

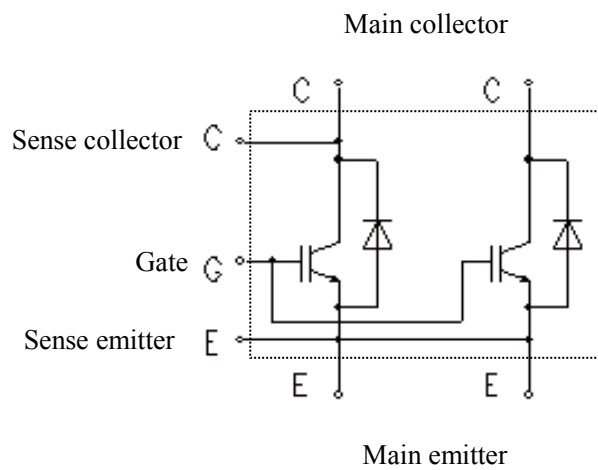

WARNING

1. This Catalog contains the product specifications, characteristics, data, materials, and structures as of February 2013. The contents are subject to change without notice for specification changes or other reasons. When using a product listed in this Catalog, be sure to obtain the latest specifications.
2. All applications described in this Catalog exemplify the use of Fuji's products for your reference only. No right or license, either express or implied, under any patent, copyright, trade secret or other intellectual property right owned by Fuji Electric Co., Ltd. is (or shall be deemed) granted. Fuji Electric Co., Ltd. makes no representation or warranty, whether express or implied, relating to the infringement or alleged infringement of other's intellectual property rights which may arise from the use of the applications described herein.
3. Although Fuji Electric Co., Ltd. is enhancing product quality and reliability, a small percentage of semiconductor products may become faulty. When using Fuji Electric semiconductor products in your equipment, you are requested to take adequate safety measures to prevent the equipment from causing a physical injury, fire, or other problem if any of the products become faulty. It is recommended to make your design fail-safe, flame retardant, and free of malfunction.
4. The products introduced in this Catalog are intended for use in the following electronic and electrical equipment which has normal reliability requirements.
 - Computers • OA equipment • Communications equipment (terminal devices) • Measurement equipment
 - Machine tools • Audiovisual equipment • Electrical home appliances • Personal equipment • Industrial robots etc.
5. If you need to use a product in this Catalog for equipment requiring higher reliability than normal, such as for the equipment listed below, it is imperative to contact Fuji Electric Co., Ltd. to obtain prior approval. When using these products for such equipment, take adequate measures such as a backup system to prevent the equipment from malfunctioning even if a Fuji's product incorporated in the equipment becomes faulty.
 - Transportation equipment (mounted on cars and ships) • Trunk communications equipment
 - Traffic-signal control equipment • Gas leakage detectors with an auto-shut-off feature
 - Emergency equipment for responding to disasters and anti-burglary devices • Safety devices
 - Medical equipment
6. Do not use products in this Catalog for the equipment requiring strict reliability such as the following and equivalents to strategic equipment (without limitation).
 - Space equipment • Aeronautic equipment • Nuclear control equipment
 - Submarine repeater equipment
7. Copyright ©1996-2013 by Fuji Electric Co., Ltd. All rights reserved.
No part of this Catalog may be reproduced in any form or by any means without the express permission of Fuji Electric Co., Ltd.
8. If you have any question about any portion in this Catalog, ask Fuji Electric Co., Ltd. or its sales agents before using the product. Neither Fuji Electric Co., Ltd. nor its agents shall be liable for any injury caused by any use of the products not in accordance with instructions set forth herein.