

## Rectifier Diodes

### 1N4001F ~ 1N4007F

#### ■ Features

- Low forward voltage drop
- High current capability
- Easy pick and place
- High surge current capability
- Plastic material used carries Underwriters

Laboratory Classification 94V-0

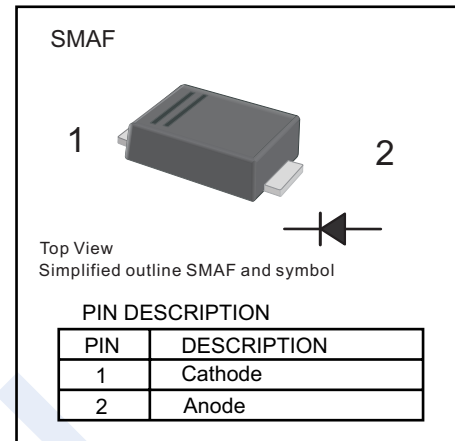

#### ■ Absolute Maximum Ratings Ta = 25°C

Parameter	Symbol	1N 4001F	1N 4002F	1N 4003F	1N 4004F	1N 4005F	1N 4006F	1N 4007F	Unit	
Repetitive Peak Reverse Voltage	V <sub>RRM</sub>	50	100	200	400	600	800	1000	V	
RMS Voltage	V <sub>RMS</sub>	35	70	140	280	420	560	700		
Maximum DC Blocking Voltage	V <sub>DC</sub>	50	100	200	400	600	800	1000		
Forward Voltage @ 1A	V <sub>F</sub>	1.1								A
Averaged Forward Current. T <sub>T</sub> =100°C	I <sub>FAV</sub>	1								
Peak Forward Surge Current @ 8.3ms	I <sub>FSM</sub>	40							30	
Maximum DC Reverse Current Ta=25°C Ta=125°C	I <sub>R</sub>	5								μA
		50								
Maximum Reverse Current *1	I <sub>trr</sub>	1.5								us
Typical Junction Capacitance *2	C <sub>j</sub>	12								pF
Thermal Resistance Junction to Ambient	R <sub>θJA</sub>	75						85		°C/W
Thermal Resistance Junction to Lead *3	R <sub>θJL</sub>	27						30		
Junction Temperature	T <sub>j</sub>	150								°C
Storage Temperature	T <sub>stg</sub>	-55 to 150								

\* 1 Reverse Recovery Test Conditions: I<sub>F</sub>=0.5A, I<sub>R</sub>=1.0A, I<sub>RR</sub>=0.25A

\* 2 Measured at 1 MHz and Applied V<sub>R</sub>=4.0 V

#### ■ Marking

NO.	1N4001F	1N4002F	1N4003F	1N4004F	1N4005F	1N4006F	1N4007F
Marking	M1	M2	M3	M4	M5	M6	M7

# Rectifier Diodes

## 1N4001F ~ 1N4007F

■ Typical Characteristics

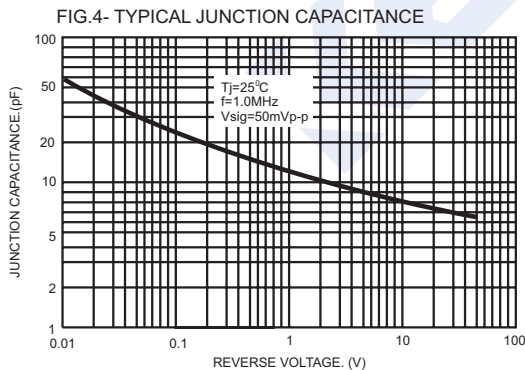
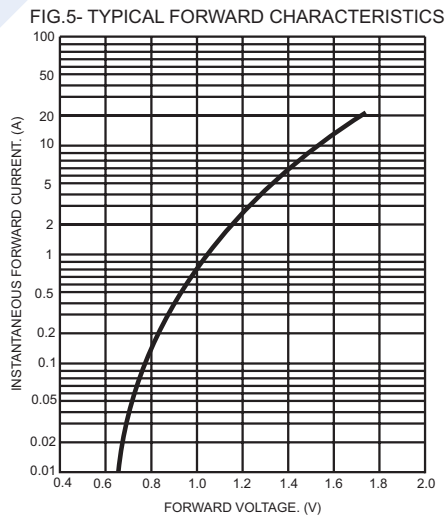
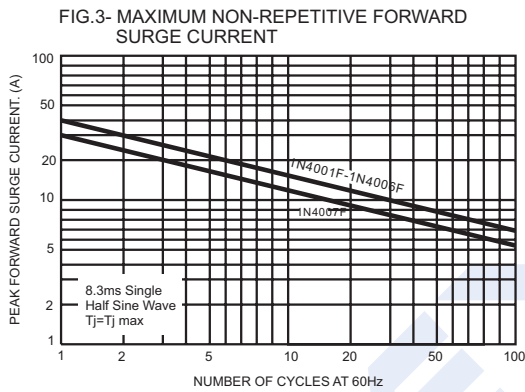
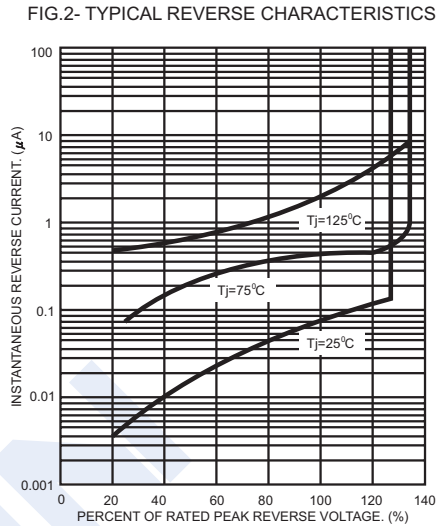
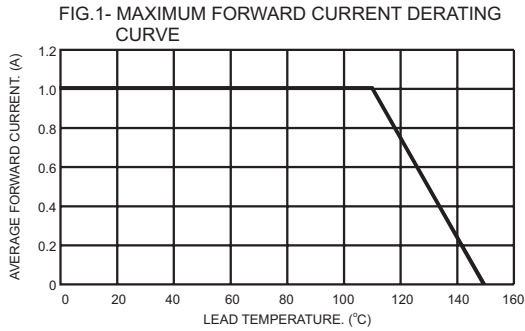
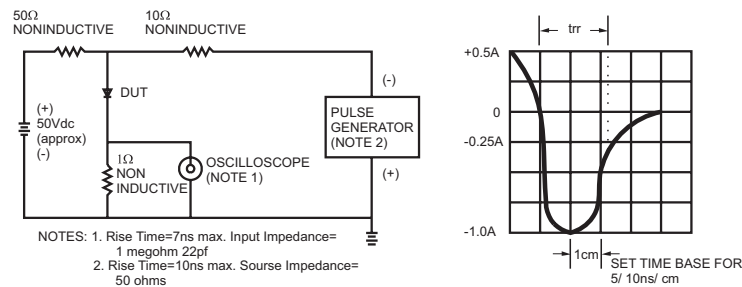

FIG.6- REVERSE RECOVERY TIME CHARACTERISTIC AND TEST CIRCUIT DIAGRAM



## Rectifier Diodes

### 1N4001F ~ 1N4007F

#### ■ Package Outline Dimensions

Plastic surface mounted package; 2 leads

SMAF

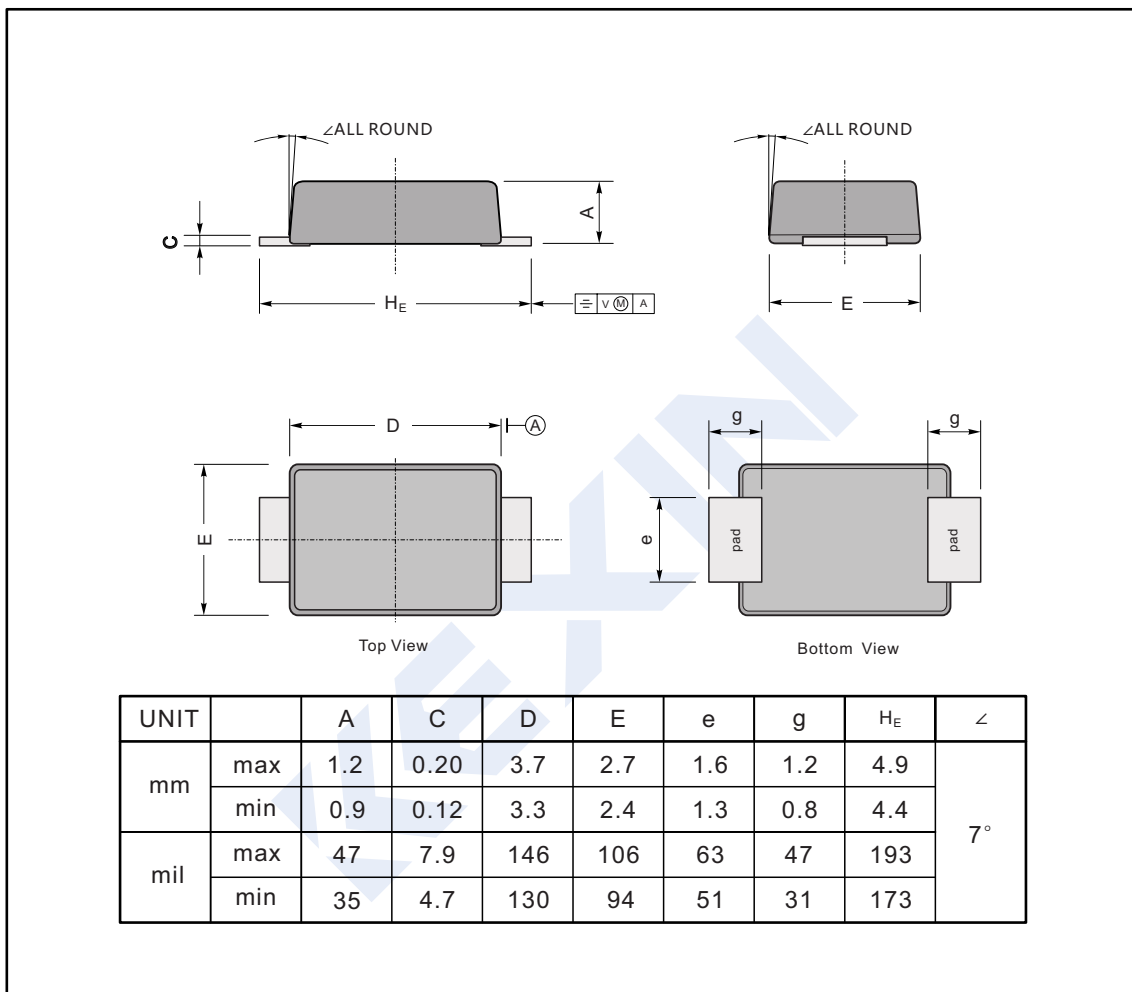

#### ■ The recommended mounting pad size

