

1N4099...1N4135

SILICON PLANAR LOW NOISE ZENER DIODES

FEATURES

- Low noise
- Low reverse leakage

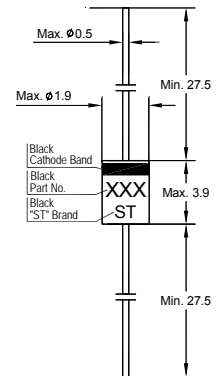

Glass Case DO-35
Dimensions in mm

Absolute Maximum Ratings ($T_a = 25\text{ }^\circ\text{C}$)

Parameter	Symbol	Value	Unit
Power Dissipation	P_{tot}	500 ¹⁾	mW
Junction Temperature	T_j	200	$^\circ\text{C}$
Storage Temperature Range	T_s	- 65 to + 200	$^\circ\text{C}$

¹⁾ Valid provided that leads are kept at ambient temperature at a distance of 8 mm from case.

Characteristics at $T_a = 25\text{ }^\circ\text{C}$

Parameter	Symbol	Max.	Unit
Forward Voltage at $I_F = 200\text{ mA}$	V_F	1.1	V

¹⁾ Valid provided that leads are kept at ambient temperature at a distance of 8 mm from case.

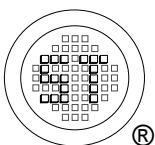

SEMTECH ELECTRONICS LTD.

(Subsidiary of Sino-Tech International Holdings Limited, a company
listed on the Hong Kong Stock Exchange, Stock Code: 724)



ISO/TS 16949 : 2002
Certificate No. 05103



ISO 14001:2004
Certificate No. 7116



ISO 9001:2000
Certificate No. 0506088

Dated : 20/06/2007

1N4099...1N4135

Characteristics at $T_a = 25\text{ }^\circ\text{C}$

Type	Zener Voltage Range ³⁾		Maximum Zener Impedance ²⁾	Maximum Reverse Leakage Current		Maximum Zener Current
	V_{Znom} V	I_{ZT} μA		Z_{ZT} Ω	I_R μA	
1N4099	6.8	250	200	10	5.17	56
1N4100	7.5	250	200	10	5.7	51
1N4101	8.2	250	200	1	6.24	46
1N4102	8.7	250	200	1	6.61	44
1N4103	9.1	250	200	1	6.92	42
1N4104	10	250	200	1	7.6	38
1N4105	11	250	200	0.05	8.44	35
1N4106	12	250	200	0.05	9.12	32
1N4107	13	250	200	0.05	9.87	29
1N4108	14	250	200	0.05	10.65	27
1N4109	15	250	100	0.05	11.4	25
1N4110	16	250	100	0.05	12.15	24
1N4111	17	250	100	0.05	12.92	22
1N4112	18	250	100	0.05	13.67	21
1N4113	19	250	150	0.05	14.44	20
1N4114	20	250	150	0.01	15.2	19
1N4115	22	250	150	0.01	16.72	17
1N4116	24	250	150	0.01	18.25	16
1N4117	25	250	150	0.01	19	15
1N4118	27	250	150	0.01	20.45	14
1N4119	28	250	200	0.01	21.28	14
1N4120	30	250	200	0.01	22.8	13
1N4121	33	250	200	0.01	25.08	12
1N4122	36	250	200	0.01	27.38	11
1N4123	39	250	200	0.01	29.65	9.8
1N4124	43	250	250	0.01	32.65	8.9
1N4125	47	250	250	0.01	35.75	8.1
1N4126	51	250	300	0.01	38.76	7.5
1N4127	56	250	300	0.01	42.6	6.7
1N4128	60	250	400	0.01	45.6	6.4
1N4129	62	250	500	0.01	47.1	6.1
1N4130	68	250	700	0.01	51.68	5.6
1N4131	75	250	700	0.01	57	5.1
1N4132	82	250	800	0.01	62.32	4.6
1N4133	87	250	1000	0.01	66.12	4.4
1N4134	91	250	1200	0.01	69.16	4.2
1N4135	100	250	1500	0.01	76	3.8

¹⁾ The type numbers shown above have a standard tolerance of $\pm 5\%$ on the nominal Zener voltage. Also available in 2% and 1% tolerance, suffix C and D respectively. V_Z is measured with the diode in thermal equilibrium in 25 °C still air.

²⁾ Zener impedance is derived by superimposing on I_{ZT} , a 60 Hz rms a.c. current equal to 10% of I_{ZT} (25 μA a.c.).

³⁾ Tested with pulses $t_p = 20$ ms.

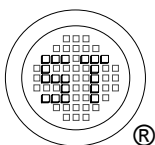

SEMTECH ELECTRONICS LTD.

(Subsidiary of Sino-Tech International Holdings Limited, a company listed on the Hong Kong Stock Exchange, Stock Code: 724)



ISO/TS 16949:2002 Certificate No. 05103
 ISO 14001:2004 Certificate No. 7116
 ISO 9001:2000 Certificate No. 0506088

Dated : 20/06/2007

1N4099...1N4135

Noise density, (N_d) is specified in microvolts-rms per square-root-hertz. Actual measurement is performed using a 1KHz to 8KHz frequency bandpass filter at a constant Zener test current (I_{zT}) at 25 °C ambient temperature. N_d is calculated from the formula.

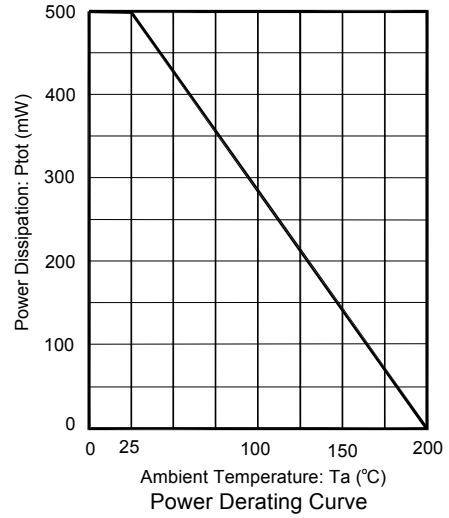
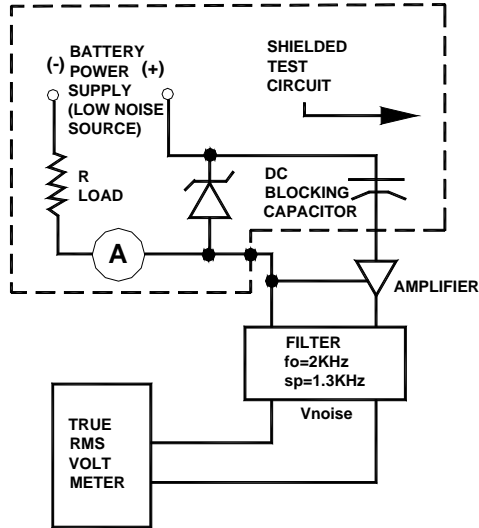

Capacitance vs. V_z Curve

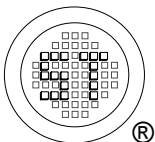
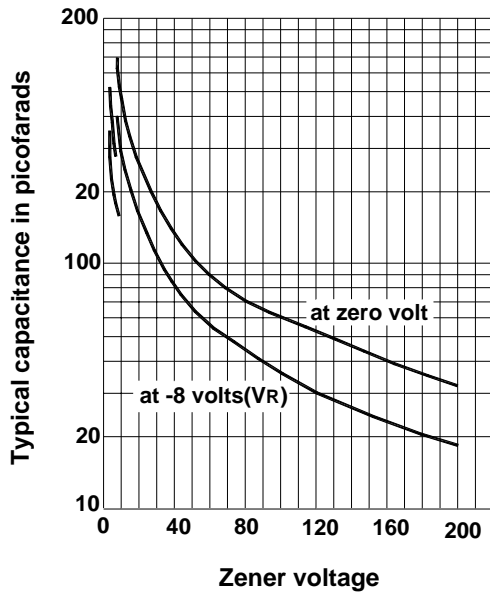

SEMTECH ELECTRONICS LTD.

(Subsidiary of Sino-Tech International Holdings Limited, a company listed on the Hong Kong Stock Exchange, Stock Code: 724)



ISO/TS 16949 : 2002
Certificate No. 05103



ISO 14001:2004
Certificate No. 7116



ISO 9001:2000
Certificate No. 0506088

Dated : 20/06/2007