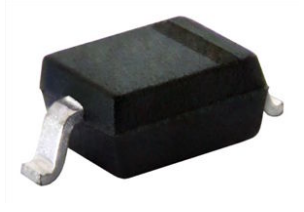




Small Signal Fast Switching Diode



FEATURES

- Silicon epitaxial planar diode
- Fast switching diode
- AEC-Q101 qualified available (part number on request)
- Base P/N-G3 - green, commercial grade
- Material categorization: for definitions of compliance please see www.vishay.com/doc?99912



DESIGN SUPPORT TOOLS click logo to get started



MECHANICAL DATA

Case: SOD-323

Weight: approx. 4 mg

Packaging codes / options:

18/10K per 13" reel (8 mm tape), 10K/box

08/3K per 7" reel (8 mm tape), 15K/box

| PARTS TABLE | | | | |
|-------------|----------------------------------|-----------------------|--------------|---------------|
| PART | ORDERING CODE | CIRCUIT CONFIGURATION | TYPE MARKING | REMARKS |
| 1N4151WS-G | 1N4151WS-G3-08 or 1N4151WS-G3-18 | Single | AL | Tape and reel |

| ABSOLUTE MAXIMUM RATINGS (T _{amb} = 25 °C, unless otherwise specified) | | | | |
|--|------------------------------------|--------------------|-------|------|
| PARAMETER | TEST CONDITION | SYMBOL | VALUE | UNIT |
| Reverse voltage | | V _R | 50 | V |
| Repetitive peak reverse voltage | | V _{RRM} | 75 | V |
| Average rectified current half wave rectification with resistive load ⁽¹⁾ | f ≥ 50 Hz | I _{F(AV)} | 150 | mA |
| Surge current | t < 1 s and T _j = 25 °C | I _{FSM} | 500 | mA |
| Power dissipation ⁽¹⁾ | | P _{tot} | 200 | mW |

| THERMAL CHARACTERISTICS (T _{amb} = 25 °C, unless otherwise specified) | | | | |
|--|----------------|-------------------|-------------|------|
| PARAMETER | TEST CONDITION | SYMBOL | VALUE | UNIT |
| Thermal resistance junction to ambient air ⁽¹⁾ | | R _{thJA} | 650 | K/W |
| Junction temperature | | T _j | 150 | °C |
| Storage temperature range | | T _{stg} | -65 to +150 | °C |
| Operating temperature range | | T _{op} | -55 to +150 | °C |

Note

⁽¹⁾ Valid provided that electrodes are kept at ambient temperature

| ELECTRICAL CHARACTERISTICS ($T_{amb} = 25\text{ }^{\circ}\text{C}$, unless otherwise specified) | | | | | | |
|--|---|------------|------|------|------|---------------|
| PARAMETER | TEST CONDITION | SYMBOL | MIN. | TYP. | MAX. | UNIT |
| Forward voltage | $I_F = 50\text{ mA}$ | V_F | | | 1 | V |
| Leakage current | $V_R = 50\text{ V}$ | I_R | | | 50 | nA |
| | $V_R = 20\text{ V}, T_j = 150\text{ }^{\circ}\text{C}$ | I_R | | | 50 | μA |
| Reverse breakdown voltage | $I_R = 5\text{ }\mu\text{A}$ (pulsed) | $V_{(BR)}$ | 75 | | | V |
| Capacitance | $V_F = V_R = 0\text{ V}$ | | | | 2 | pF |
| Reverse recovery time | $I_F = 10\text{ mA}, I_R = 10\text{ mA}$ $i_R = 1\text{ mA}$ | t_{rr} | | | 4 | ns |
| | $I_F = 10\text{ mA}, i_R = 1\text{ mA},$ $V_R = 6\text{ V}, R_L = 100\text{ }\Omega$ | t_{rr} | | | 2 | ns |

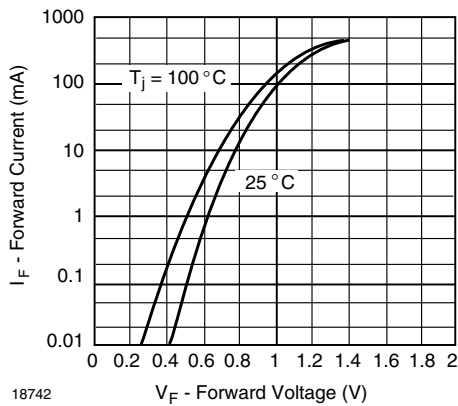
TYPICAL CHARACTERISTICS ($T_{amb} = 25\text{ }^{\circ}\text{C}$, unless otherwise specified)


Fig. 1 - Forward Current vs. Forward Voltage

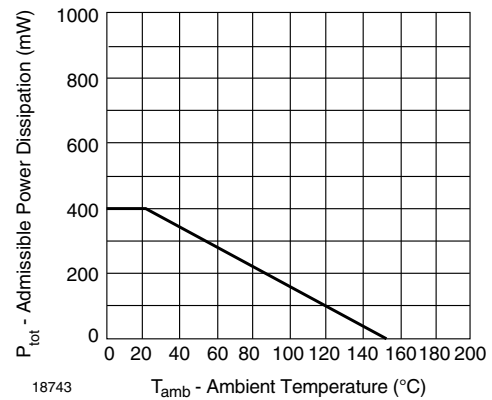


Fig. 3 - Admissible Power Dissipation vs. Ambient Temperature

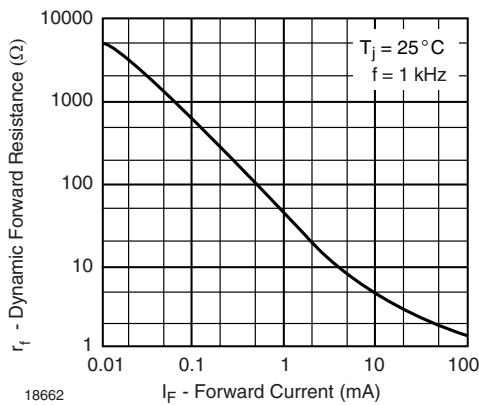


Fig. 2 - Dynamic Forward Resistance vs. Forward Current

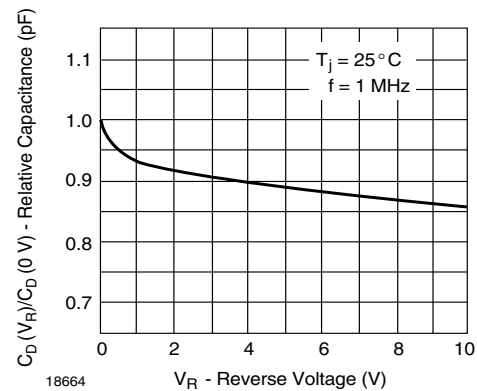


Fig. 4 - Relative Capacitance vs. Reverse Voltage



Fig. 5 - Leakage Current vs. Junction Temperature

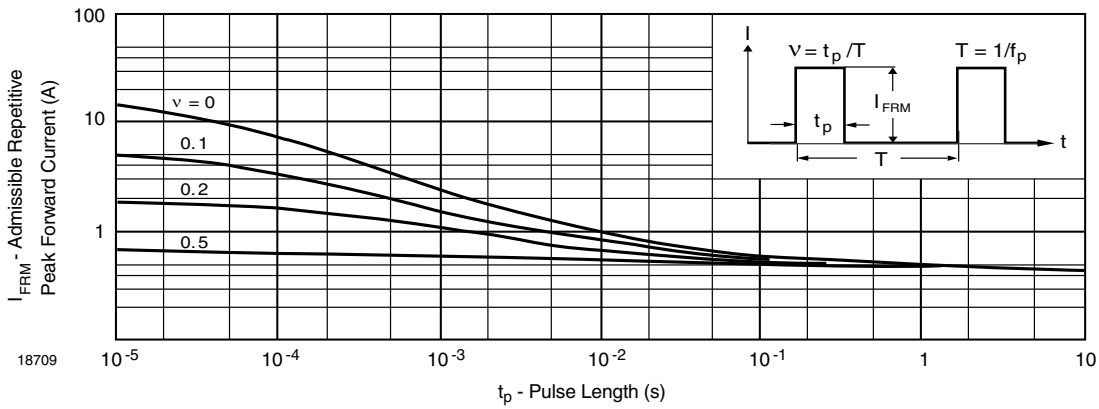
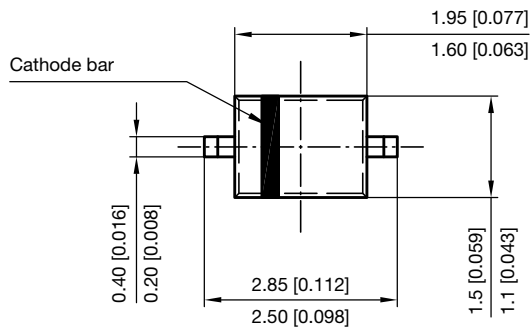
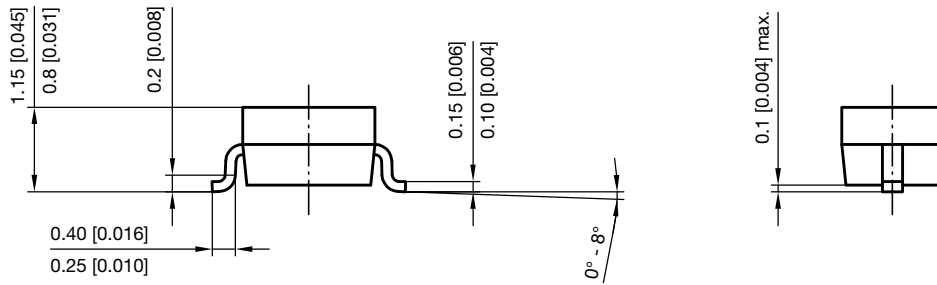


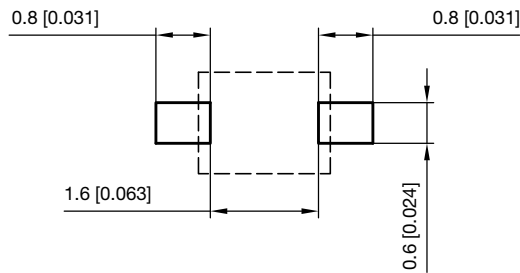
Fig. 6 - Admissible Repetitive Peak Forward Current vs. Pulse Duration



PACKAGE DIMENSIONS in millimeters (inches): SOD-323



Footprint recommendation:



Document no.: S8-V-3910.02-001 (4)
Created - Date: 24.August.2004
Rev. 6 - Date: 23.Sept.2016
17443



Disclaimer

ALL PRODUCT, PRODUCT SPECIFICATIONS AND DATA ARE SUBJECT TO CHANGE WITHOUT NOTICE TO IMPROVE RELIABILITY, FUNCTION OR DESIGN OR OTHERWISE.

Vishay Intertechnology, Inc., its affiliates, agents, and employees, and all persons acting on its or their behalf (collectively, "Vishay"), disclaim any and all liability for any errors, inaccuracies or incompleteness contained in any datasheet or in any other disclosure relating to any product.

Vishay makes no warranty, representation or guarantee regarding the suitability of the products for any particular purpose or the continuing production of any product. To the maximum extent permitted by applicable law, Vishay disclaims (i) any and all liability arising out of the application or use of any product, (ii) any and all liability, including without limitation special, consequential or incidental damages, and (iii) any and all implied warranties, including warranties of fitness for particular purpose, non-infringement and merchantability.

Statements regarding the suitability of products for certain types of applications are based on Vishay's knowledge of typical requirements that are often placed on Vishay products in generic applications. Such statements are not binding statements about the suitability of products for a particular application. It is the customer's responsibility to validate that a particular product with the properties described in the product specification is suitable for use in a particular application. Parameters provided in datasheets and / or specifications may vary in different applications and performance may vary over time. All operating parameters, including typical parameters, must be validated for each customer application by the customer's technical experts. Product specifications do not expand or otherwise modify Vishay's terms and conditions of purchase, including but not limited to the warranty expressed therein.

Except as expressly indicated in writing, Vishay products are not designed for use in medical, life-saving, or life-sustaining applications or for any other application in which the failure of the Vishay product could result in personal injury or death. Customers using or selling Vishay products not expressly indicated for use in such applications do so at their own risk. Please contact authorized Vishay personnel to obtain written terms and conditions regarding products designed for such applications.

No license, express or implied, by estoppel or otherwise, to any intellectual property rights is granted by this document or by any conduct of Vishay. Product names and markings noted herein may be trademarks of their respective owners.