

Technical Data

DIODE



maximum ratings

Voltage, Reverse (VR)	200.0	V	NO.	1N4245
Voltage, Reverse Peak (VRM)		V	TYPE	SI - RECTIFIER
Current at VR = 0V (IO)		A		
Current Average Rectified (IF)	1.0	A		
Current Surge Peak (IFM)		A	CASE	SOD-57
Current, Surge (IFM) at tp = 8.3 ms	30.0	A		
Max. Power Dissipation (PT) at TC = 25 °C		W		
Max. Thermal Resistance (Rth J-A)	50.0	°C/W		
Max. Junction Temperature (TJ)	175.0	°C		

PERFORMANCE CHARACTERISTICS at $T_c = 25^\circ\text{C}$, unless otherwise noted

NO.	SYMBOL	CONDITIONS	MIN.	MAX.	UNITS
1.	IR	VR = 200.0 V	-	1.0	μA
2.	IR	VR = 200.0 V, TA = 150.0° C	-	200.0	μA
3.	VF	IF = 1.0 A (1)	-	1.2	V
4.	trr	IF = 0.5 A, IR = 1.0 A	-	2.0	μs
5.					
6.					
7.					
8.					
9.					
10.					
11.					
12.					
13.					
14.					
15.					
16.					
17.					
18.					
19.					
20.					

Notes (1)pulse-tested $t_p \leq 300 \mu\text{s}$, duty cycle $\leq 2\%$

DIMENSIONS
in mm

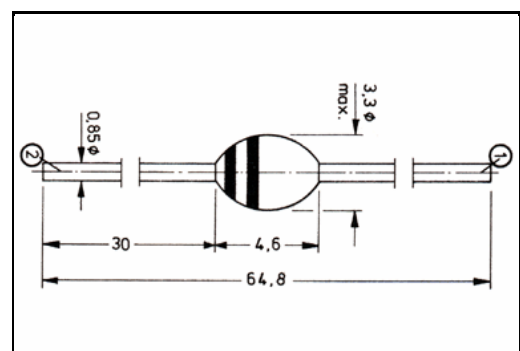

Marking 4245
Customer GENERAL PURPOSE