

1.5KE6.8,A thru 1.5KE200,A
See Page 4-74



Designers Data Sheet

1N746 thru 1N759
1N957A thru 1N986A
1N4370 thru 1N4372

GLASS ZENER DIODES
500 MILLIWATTS
2.4-110 VOLTS

500-MILLIWATT HERMETICALLY SEALED GLASS SILICON ZENER DIODES

- Complete Voltage Range — 2.4 to 110 Volts
- DO-35 Package — Smaller than Conventional DO-7 Package
- Double Slug Type Construction
- Metallurgically Bonded Construction
- Nitride Passivated Die

Designer's Data for "Worst Case" Conditions

The Designer's Data sheets permit the design of most circuits entirely from the information presented. Limit curves — representing boundaries on device characteristics — are given to facilitate "worst case" design.

4

MAXIMUM RATINGS

Rating	Symbol	Value	Unit
DC Power Dissipation @ $T_L \leq 50^\circ\text{C}$, Lead Length = 3/8"	P_D	400	mW
*JEDEC Registration		3.2	mW/ $^\circ\text{C}$
*Derate above $T_L = 50^\circ\text{C}$		500	mW
Motorola Device Ratings Derate above $T_L = 50^\circ\text{C}$		3.33	mW/ $^\circ\text{C}$
Operating and Storage Junction Temperature Range	T_J, T_{stg}	-65 to +175	$^\circ\text{C}$
*JEDEC Registration		-65 to +200	
Motorola Device Ratings			

*Indicates JEDEC Registered Data.

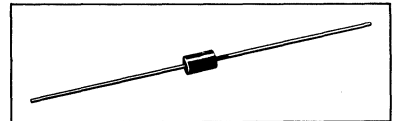

MECHANICAL CHARACTERISTICS

MAXIMUM LEAD TEMPERATURE FOR SOLDERING PURPOSES: 230°C , 1/16"
from case for 10 seconds

FINISH: All external surfaces are corrosion resistant with readily solderable leads.

POLARITY: Cathode indicated by color band. When operated in zener mode, cathode will be positive with respect to anode.

MOUNTING POSITION: Any

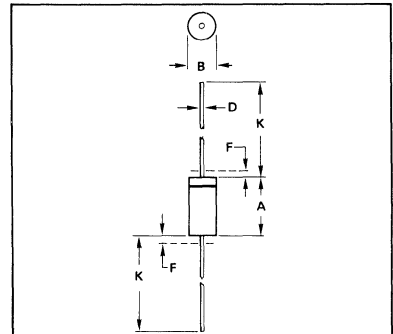

NOTES:

1. PACKAGE CONTOUR OPTIONAL WITHIN A AND B. HEAT SLUGS, IF ANY, SHALL BE INCLUDED WITHIN THIS CYLINDER, BUT NOT SUBJECT TO THE MINIMUM LIMIT OF B.
2. LEAD DIAMETER NOT CONTROLLED IN ZONE F TO ALLOW FOR FLASH, LEAD FINISH BUILDUP AND MINOR IRREGULARITIES OTHER THAN HEAT SLUGS.
3. POLARITY DENOTED BY CATHODE BAND.
4. DIMENSIONING AND TOLERANCING PER ANSI Y14.5, 1973.

DIM	MILLIMETERS		INCHES	
	MIN	MAX	MIN	MAX
A	3.05	5.08	0.120	0.200
B	1.52	2.29	0.060	0.090
D	0.46	0.56	0.018	0.022
F	-	1.27	-	0.050
K	25.40	38.10	1.000	1.500

All JEDEC dimensions and notes apply.

CASE 299-02
DO-204H
(DO-35)

STEADY STATE POWER DERATING

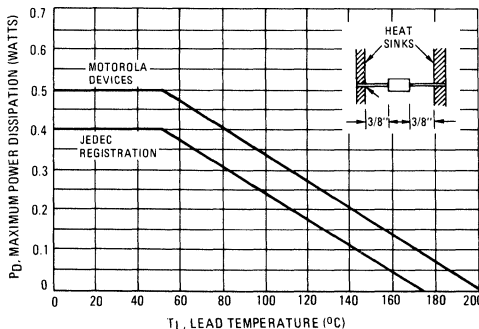

1N746 thru 1N759, 1N957A thru 1N986A, 1N4370 thru 1N4372

ELECTRICAL CHARACTERISTICS ($T_A = 25^\circ\text{C}$, $V_F = 1.5\text{ V}$ max at 200 mA for all types)

Type Number (Note 1)	Nominal Zener Voltage V_Z @ I_ZT (Note 2) Volts	Test Current I_ZT mA	Maximum Zener Impedance Z_{ZT} @ I_ZT (Note 3) Ohms	*Maximum DC Zener Current I_{ZM} (Note 4) mA		Maximum Reverse Leakage Current	
				$T_A = 25^\circ\text{C}$ I_R @ $V_R = 1\text{ V}$ μA	$T_A = 150^\circ\text{C}$ I_R @ $V_R = 1\text{ V}$ μA		
1N4370	2.4	20	30	150	190	100	200
1N4371	2.7	20	30	135	165	75	150
1N4372	3.0	20	29	120	150	50	100
1N746	3.3	20	28	110	135	10	30
1N747	3.6	20	24	100	125	10	30
1N748	3.9	20	23	95	115	10	30
1N749	4.3	20	22	85	105	2	30
1N750	4.7	20	19	75	95	2	30
1N751	5.1	20	17	70	85	1	20
1N752	5.6	20	11	65	80	1	20
1N753	6.2	20	7	60	70	0.1	20
1N754	6.8	20	5	55	65	0.1	20
1N755	7.5	20	6	50	60	0.1	20
1N756	8.2	20	8	45	55	0.1	20
1N757	9.1	20	10	40	50	0.1	20
1N758	10	20	17	35	45	0.1	20
1N759	12	20	30	30	35	0.1	20

Type Number (Note 1)	Nominal Zener Voltage V_Z (Note 2) Volts	Test Current I_ZT mA	Maximum Zener Impedance (Note 3)			*Maximum DC Zener Current I_{ZM} (Note 4) mA		Maximum Reverse Current		
			Z_{ZT} @ I_ZT Ohms	Z_{ZK} @ I_{ZK} Ohms	I_{ZK} mA	I_R μA	Test Voltage V_{dc}	5%	10%	
1N957A	6.8	18.5	4.5	700	1.0	47	61	150	5.2	4.9
1N958A	7.5	16.5	5.5	700	0.5	42	55	75	5.7	5.4
1N959A	8.2	15	6.5	700	0.5	38	50	50	6.2	5.9
1N960A	9.1	14	7.5	700	0.5	35	45	25	6.9	6.6
1N961A	10	12.5	8.5	700	0.25	32	41	10	7.6	7.2
1N962A	11	11.5	9.5	700	0.25	28	37	5	8.4	8.0
1N963A	12	10.5	11.5	700	0.25	26	34	5	9.1	8.6
1N964A	13	9.5	13	700	0.25	24	32	5	9.9	9.4
1N965A	15	8.5	16	700	0.25	21	27	5	11.4	10.8
1N966A	16	7.8	17	700	0.25	19	37	5	12.2	11.5
1N967A	18	7.0	21	750	0.25	17	23	5	13.7	13.0
1N968A	20	6.2	25	750	0.25	15	20	5	15.2	14.4
1N969A	22	5.6	29	750	0.25	14	18	5	16.7	15.8
1N970A	24	5.2	33	750	0.25	13	17	5	18.2	17.3
1N971A	27	4.6	41	750	0.25	11	15	5	20.6	19.4
1N972A	30	4.2	49	1000	0.25	10	13	5	22.8	21.6
1N973A	33	3.8	58	1000	0.25	9.2	12	5	25.1	23.8
1N974A	36	3.4	70	1000	0.25	8.5	11	5	27.4	25.9
1N975A	39	3.2	80	1000	0.25	7.8	10	5	29.7	28.1
1N976A	43	3.0	93	1500	0.25	7.0	9.6	5	32.7	31.0
1N977A	47	2.7	105	1500	0.25	6.4	8.8	5	35.8	33.8
1N978A	51	2.5	125	1500	0.25	5.9	8.1	5	38.8	36.7
1N979A	56	2.2	150	2000	0.25	5.4	7.4	5	42.6	40.3
1N980A	62	2.0	185	2000	0.25	4.9	6.7	5	47.1	44.6
1N981A	68	1.8	230	2000	0.25	4.5	6.1	5	51.7	49.0
1N982A	75	1.7	270	2000	0.25	1.0	5.5	5	56.0	54.0
1N983A	82	1.5	330	3000	0.25	3.7	5.0	5	62.2	59.0
1N984A	91	1.4	400	3000	0.25	3.3	4.5	5	69.2	65.5
1N985A	100	1.3	500	3000	0.25	3.0	4.5	5	76	72
1N986A	110	1.1	750	4000	0.25	2.7	4.1	5	83.6	79.2



NOTE 1. TOLERANCE AND VOLTAGE DESIGNATION

Tolerance Designation

The type numbers shown have tolerance designations as follows:

- 1N4370 series: $\pm 10\%$, suffix A for $\pm 5\%$ units.
- 1N746 series: $\pm 10\%$, suffix A for $\pm 5\%$ units.
- 1N957 series: suffix A for $\pm 10\%$ units, suffix B for $\pm 5\%$ units.

Voltage Designation

To designate units with zener voltages other than those listed, the Motorola type number should be modified as shown below. Unless otherwise specified, the electrical characteristics other than the nominal voltage (V_Z) and test voltage for leakage current will conform to the characteristics of the next higher voltage type shown in the table.

EXAMPLE: 1N746 series, 1N4370 series variations

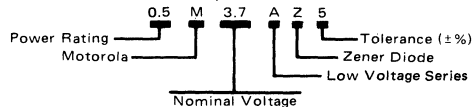

EXAMPLE: 1N957 series variations

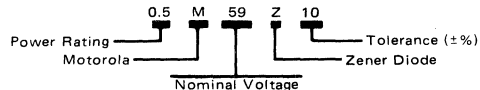

Matched Sets for Closer Tolerances or Higher Voltages

Series matched sets make zener voltages in excess of 100 volts or tolerances of less than 5% possible as well as providing lower temperature coefficients, lower dynamic impedance and greater power handling ability.

For Matched Sets or other special circuit requirements, contact your Motorola Sales Representative.

1N746 thru 1N759, 1N957A thru 1N986A, 1N4370 thru 1N4372

NOTE 2. ZENER VOLTAGE (V_Z) MEASUREMENT

Nominal zener voltage is measured with the device junction in thermal equilibrium at the lead temperature of $30^\circ\text{C} \pm 1^\circ\text{C}$ and 3/8" lead length.

NOTE 3. ZENER IMPEDANCE (Z_Z) DERIVATION

Z_{ZT} and Z_{ZK} are measured by dividing the ac voltage drop across the device by the ac current applied. The specified limits are for $I_Z(\text{ac}) = 0.1 I_Z(\text{dc})$ with the ac frequency = 60 Hz.

NOTE 4. MAXIMUM ZENER CURRENT RATINGS (I_{ZM})

Maximum zener current ratings are based on the maximum voltage of a 10% 1N746 type unit or a 20% 1N957 type unit. For closer tolerance units (10% or 5%) or units where the actual zener voltage (V_Z) is known at the operating point, the maximum zener current may be increased and is limited by the derating curve.

Under high power-pulse operation, the zener voltage will vary with time and may also be affected significantly by the zener resistance. For best regulation, keep current excursions as low as possible.

Surge limitations are given in Figure 6. They are lower than would be expected by considering only junction temperature, as current crowding effects cause temperatures to be extremely high in small spots, resulting in device degradation should the limits of Figure 6 be exceeded.

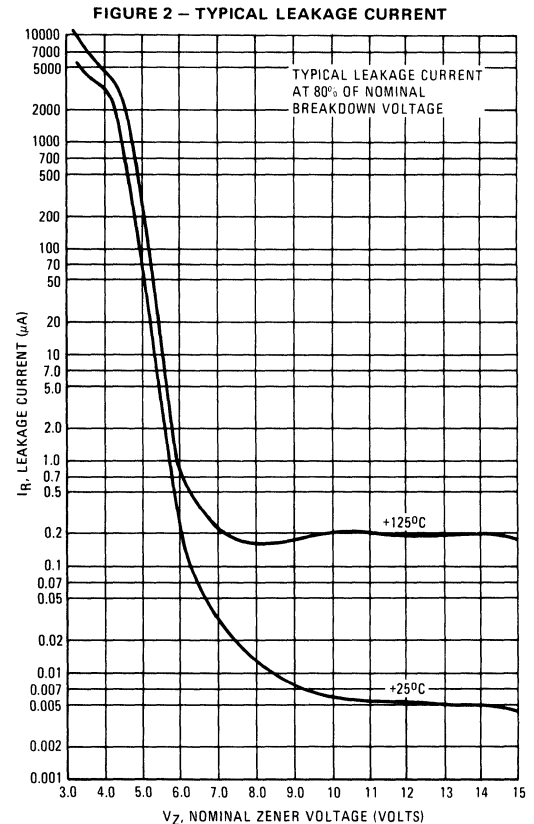
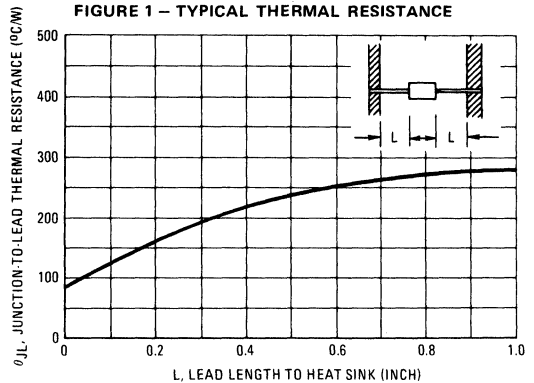

4

APPLICATION NOTE

Since the actual voltage available from a given zener diode is temperature dependent, it is necessary to determine junction temperature under any set of operating conditions in order to calculate its value. The following procedure is recommended:

Lead Temperature, T_L , should be determined from:

$$T_L = \theta_{LA} P_D + T_A$$

θ_{LA} is the lead-to-ambient thermal resistance ($^\circ\text{C}/\text{W}$) and P_D is the power dissipation. The value for θ_{LA} will vary and depends on the device mounting method.

θ_{LA} is generally $30\text{--}40^\circ\text{C}/\text{W}$ for the various clips and tie points in common use and for printed circuit board wiring.

The temperature of the lead can also be measured using a thermocouple placed on the lead as close as possible to the tie point. The thermal mass connected to the tie point is normally large enough so that it will not significantly respond to heat surges generated in the diode as a result of pulsed operation once steady-state conditions are achieved. Using the measured value of T_L , the junction temperature may be determined by:

$$T_J = T_L + \Delta T_{JL}$$

ΔT_{JL} is the increase in junction temperature above the lead temperature and may be found from Figure 1 for dc power.

$$\Delta T_{JL} = \theta_{JLPD}$$

For worst-case design, using expected limits of I_Z , limits of P_D and the extremes of $T_J(\Delta T_J)$ may be estimated. Changes in voltage, V_Z , can then be found from:

$$\Delta V = \theta_{VZ} \Delta T_J$$

θ_{VZ} , the zener voltage temperature coefficient, is found from Figures 3 and 4.

1N746 thru 1N759, 1N957A thru 1N986A, 1N4370 thru 1N4372

FIGURE 3 – TEMPERATURE COEFFICIENTS
 (-55°C to +150°C temperature range; 90% of the units are in the ranges indicated.)

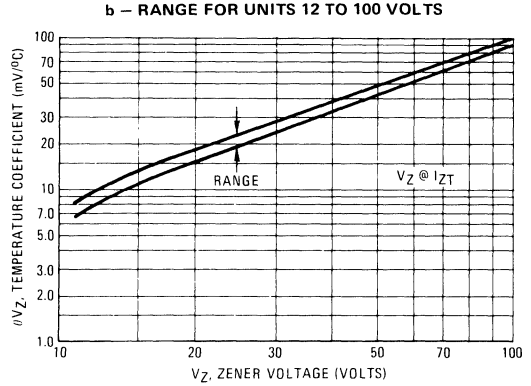
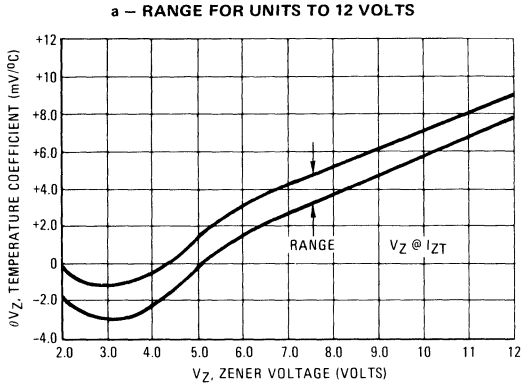

FIGURE 4 – EFFECT OF ZENER CURRENT

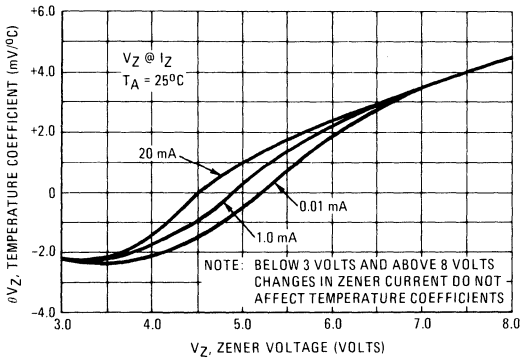

FIGURE 5 – TYPICAL CAPACITANCE

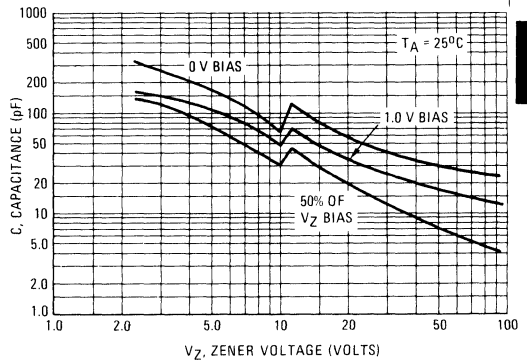
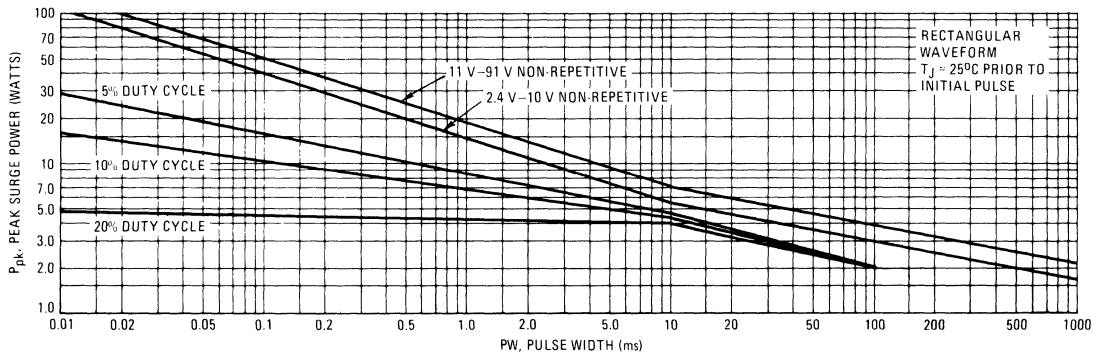

FIGURE 6 – MAXIMUM SURGE POWER



This graph represents 90 percental data points.
 For worst-case design characteristics, multiply surge power by 2/3.

1N746 thru 1N759, 1N957A thru 1N986A, 1N4370 thru 1N4372

FIGURE 7 – EFFECT OF ZENER CURRENT ON ZENER IMPEDANCE

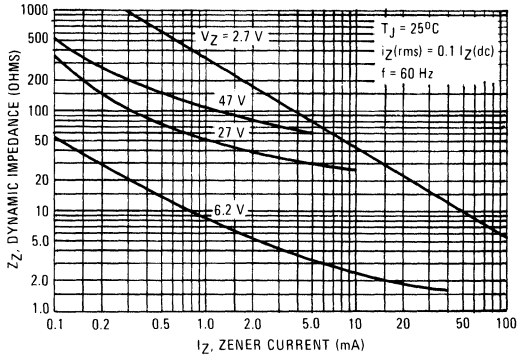

FIGURE 8 – EFFECT OF ZENER VOLTAGE ON ZENER IMPEDANCE

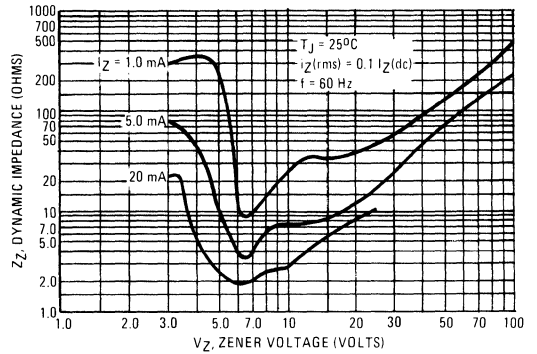

FIGURE 9 – TYPICAL NOISE DENSITY

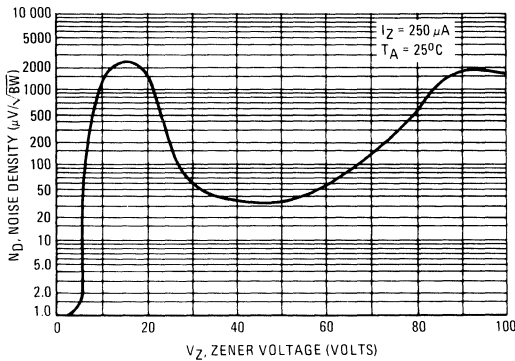

FIGURE 10 – NOISE DENSITY MEASUREMENT METHOD

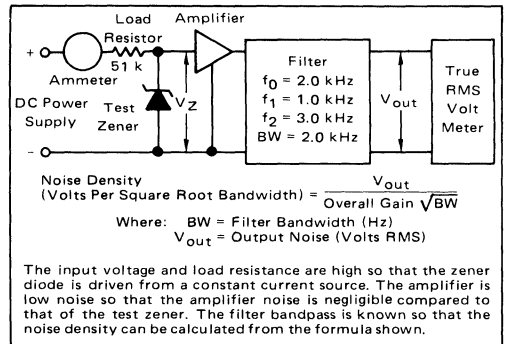
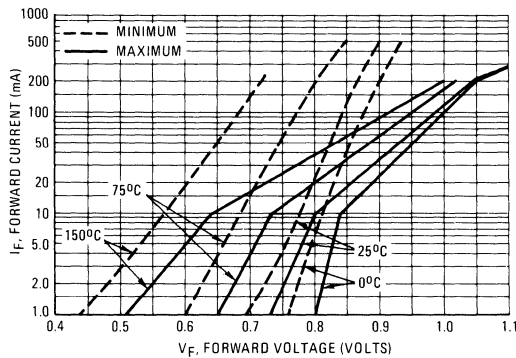

FIGURE 11 – TYPICAL FORWARD CHARACTERISTICS



1N746 thru 1N759, 1N957A thru 1N986A, 1N4370 thru 1N4372

