



1N4728A-G thru 1N4764A-G

SILICON ZENER DIODE

REVERSE VOLTAGE - **3.3** to **100** Volts
FORWARD CURRENT - **1.0** Watts

FEATURES

- Low profile package
- Built-in strain relief
- Low inductance
- High temperature soldering : 260°C /10 seconds at terminals
- Glass package has Underwriters Laboratory Flammability Classification
- In compliance with EU RoHS 2002/95/EC directives

APPLICATIONS

- Case: Molded Glass DO-41G
- Terminals: Axial leads, solderable per MIL-STD-750, Method 2026 guaranteed
- Polarity: Color band denotes positive end
- Mounting position:Any
- Weight: 0.012 ounce, 0.336 gram

DO-41G

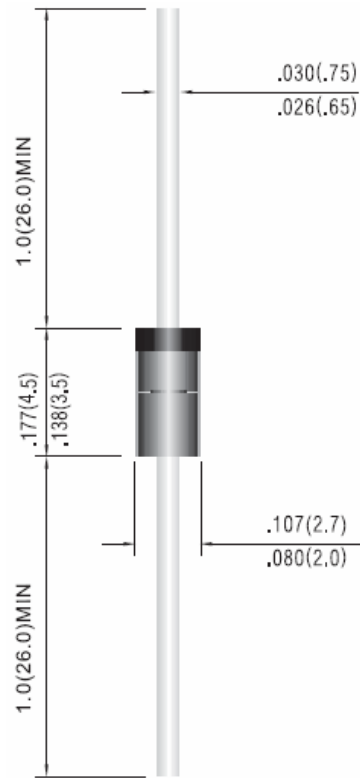

Dimensions in inches and (millimeters)

Ratings at 25°C ambient temperature unless otherwise specified.

Parameter	Symbol	Value	Units
Power Dissipation at Tamb=25°C	P _{tot}	1*	W
Junction Temperature	T _j	150	°C
Storage Temperature Range	T _{stg}	-65 ~ +200	°C

*Valid provided that leads at a distance of 10mm from case are kept at ambient temperature.

Parameter	Symbol	Min.	Typ.	Max.	Units
Thermal Resistance Junction Ambient Air	R _{θJA}	-	-	170*	K/W
Forward Voltage at I _F =200mA	V _F	-	-	1.2	V

*Valid provided that leads at a distance of 10mm from case are kept at ambient temperature.

RATING AND CHARACTERISTIC CURVES

1N4728A-G thru 1N4764A-G



NOTE:

1. Tolerance and Type Number Designation. The type numbers listed have a standard tolerance on the nominal zener voltage of + 5%
2. Specials Available Include:
 - A. Nominal zener voltages between the voltages shown and tighter voltage tolerances.
 - B. Matched sets.
3. Zener Voltage (V_z) Measurement. Guarantees the zener voltage when measured at 90 seconds while maintaining the lead temperature (T) at $30\text{ C} + 1\text{ C}$, from the diode body.
4. Zener Impedance (Z_z) Derivation. The zener impedance is derived from the 60 cycle ac voltage, which results when an ac current having an rms value equal to 10% of the dc zener current (I_{zt} or I_{zk}) is superimposed on I_{zt} or I_{zk} .
5. Surge Current (I_r) Non-Repetitive. The rating listed in the electrical characteristics table is maximum peak, non-repetitive, reverse surge current of 1/2

FIG. 1 - POWER TEMPERATURE DERATING CURVE

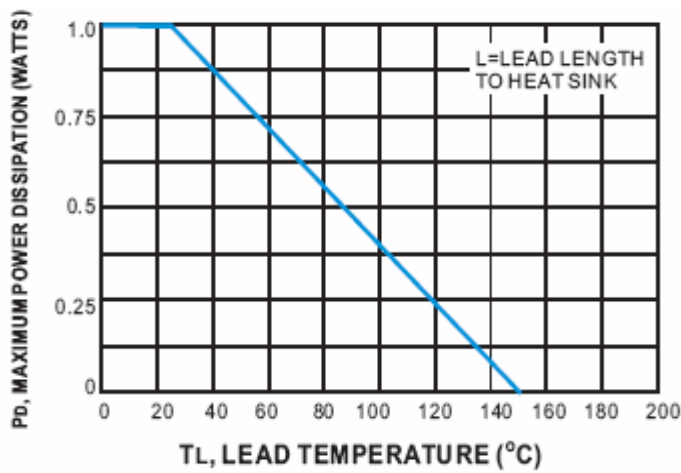
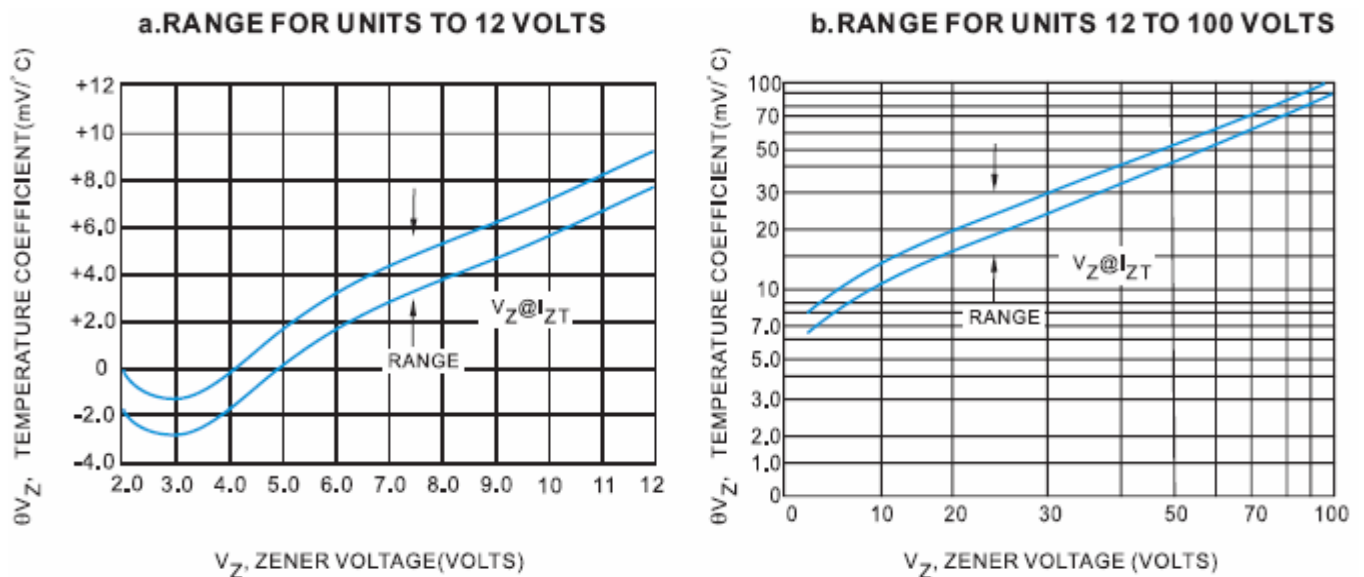

FIG.2 - TEMPERATURE COEFFICIENTS
 (-55°C to +150°C temperature range;90% of the units are in the ranges indicated.)





RATING AND CHARACTERISTIC CURVES 1N4728A-G thru 1N4764A-G

FIG. 3 - TYPICAL THERMAL RESISTANCE versus LEAD LENGTH

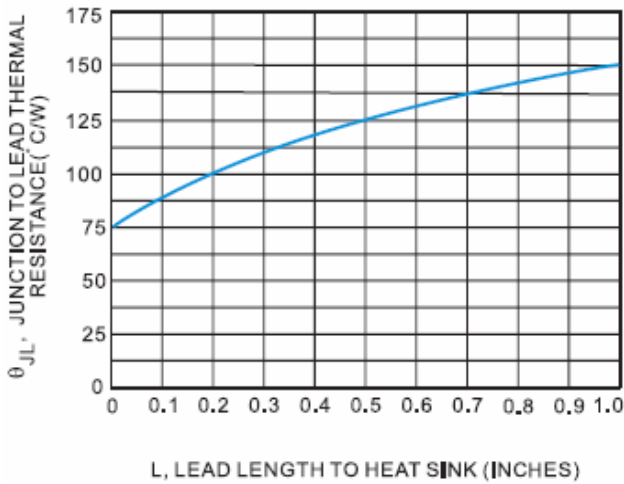

FIG. 4 - EFFECT OF ZENER CURRENT

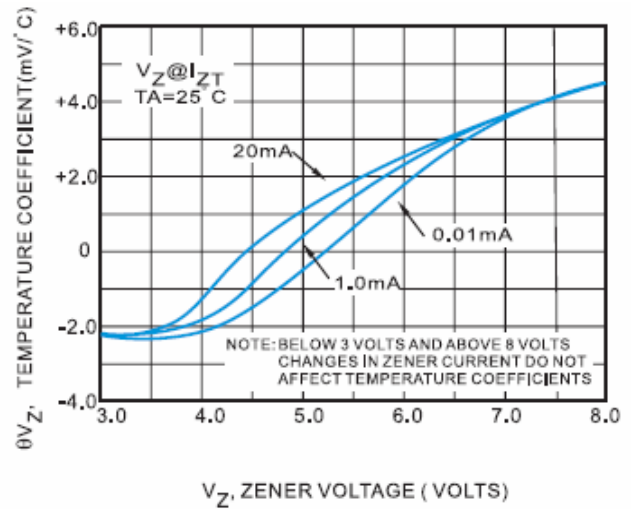
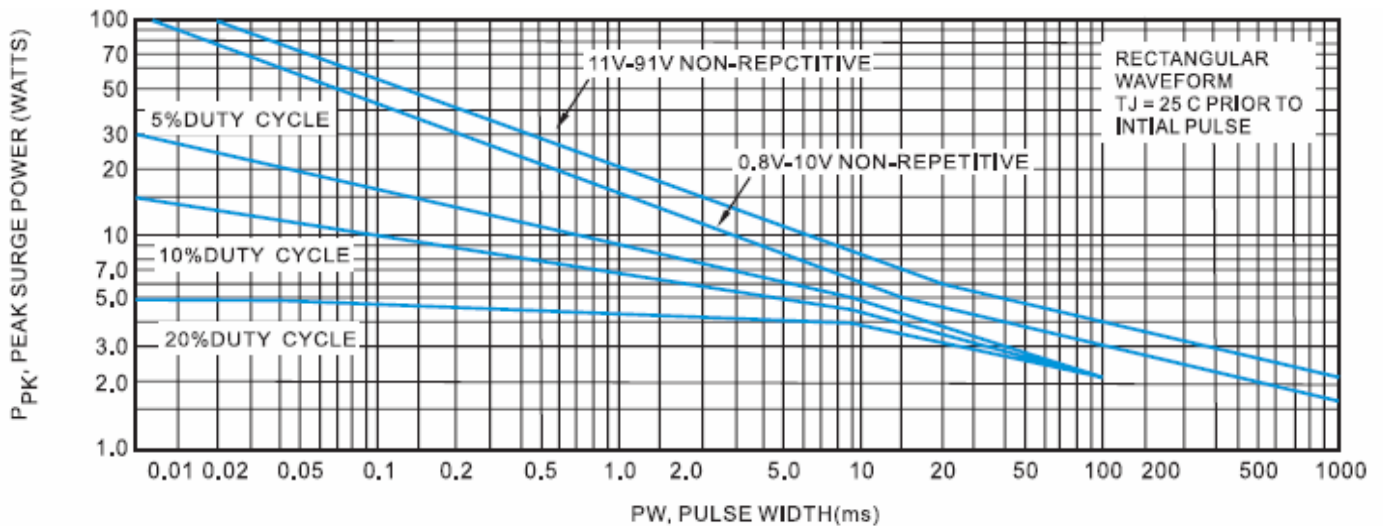

FIG. 5 - MAXIMUM SURGE POWER



This graph represents 90 percentile data points.
FOR worst-case design characteristics, multiply surge power by 2/3

FIG. 6 - EFFECT OF ZENER CURRENT ON ZENER IMPEDANCE

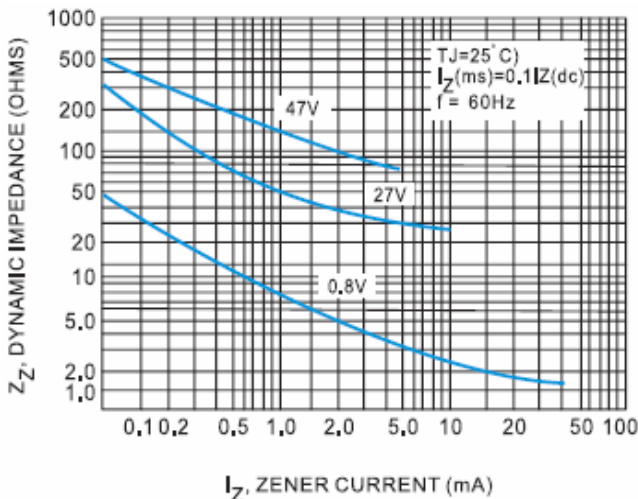

FIG. 7 - EFFECT OF ZENER VOLTAGE ON ZENER

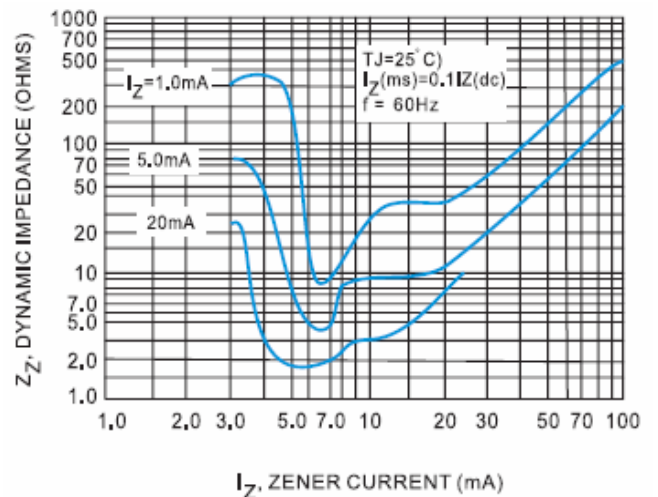

FIG. 8 - TYPICAL LEAKAGE CURRENT

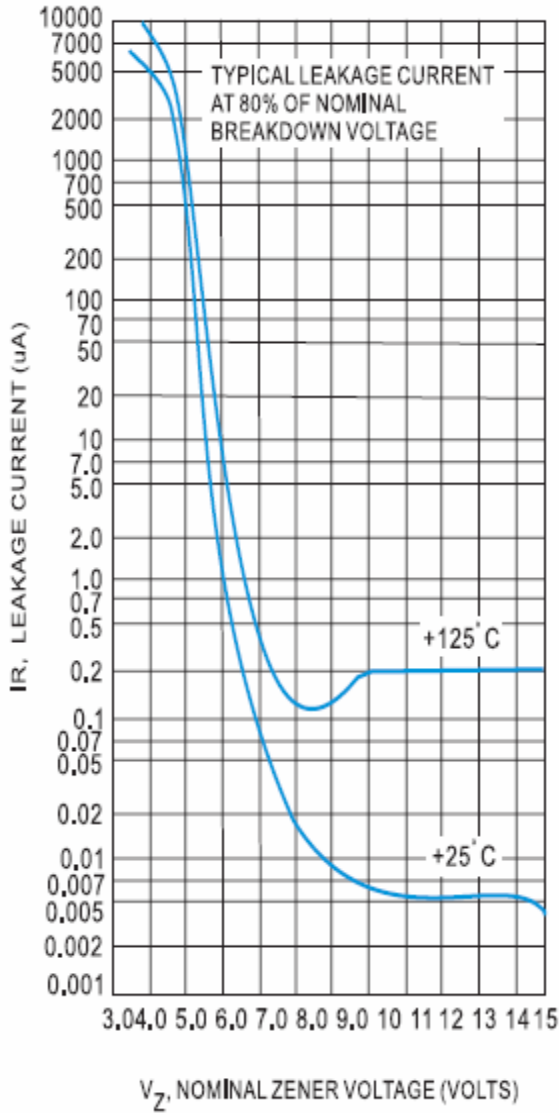

FIG. 9 - TYPICAL CAPACITANCE versus V_Z

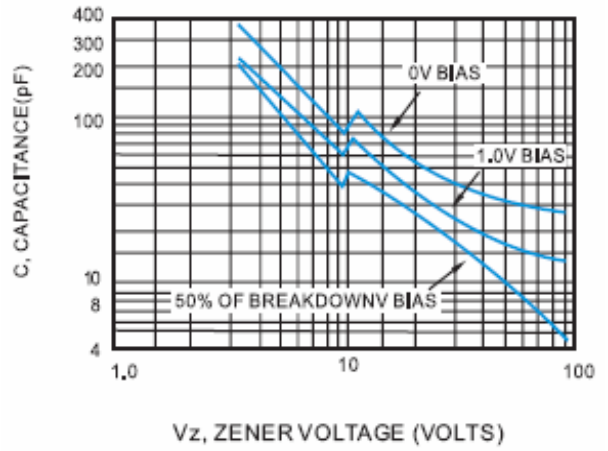
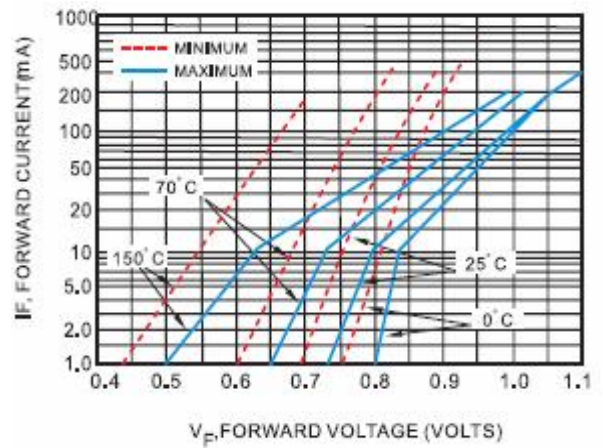

FIG. 10 - TYPICAL FORWARD CHARACTERISTICS





1N4728A-G thru 1N4764A-G

TYPE	Nominal Zener Voltage			Max. Zener Impedance				Maximum Leakage Current		Marking Code
	$V_Z @ I_{ZT}$			$Z_{ZT} @ I_{ZT}$		$Z_{ZT} @ I_{ZK}$		$I_R @ V_R$		
	Nom.V	Min.V	Max.V	Ω	mA	Ω	mA	μA	V	
1.0 Watt Zener Diodes										
1N4728A-G	3.3	3.14	3.47	10.0	76.00	400	1.00	100	1.0	1N4728A
1N4729A-G	3.6	3.42	3.78	10.0	69.00	400	1.00	100	1.0	1N4729A
1N4730A-G	3.9	3.71	4.10	9.0	64.00	400	1.00	50	1.0	1N4730A
1N4731A-G	4.3	4.09	4.52	9.0	58.00	400	1.00	10	1.0	1N4731A
1N4732A-G	4.7	4.47	4.94	8.0	53.00	500	1.00	10	1.0	1N4732A
1N4733A-G	5.1	4.85	5.36	7.0	49.00	550	1.00	10	1.0	1N4733A
1N4734A-G	5.6	5.32	5.88	5.0	45.00	600	1.00	10	2.0	1N4734A
1N4735A-G	6.2	5.89	6.51	2.0	41.00	700	1.00	10	3.0	1N4735A
1N4736A-G	6.8	6.46	7.14	3.5	37.00	700	1.00	10	4.0	1N4736A
1N4737A-G	7.5	7.13	7.88	4.0	34.00	700	0.50	10	5.0	1N4737A
1N4738A-G	8.2	7.79	8.61	4.5	31.00	700	0.50	10	6.0	1N4738A
1N4739A-G	9.1	8.65	9.56	5.0	28.00	700	0.50	10	7.0	1N4739A
1N4740A-G	10.0	9.50	10.50	7.0	25.00	700	0.25	10	7.6	1N4740A
1N4741A-G	11.0	10.45	11.55	8.0	23.00	700	0.25	5	8.4	1N4741A
1N4742A-G	12.0	11.40	12.60	9.0	21.00	700	0.25	5	9.1	1N4742A
1N4743A-G	13.0	12.35	13.65	10.0	19.00	700	0.25	5	9.9	1N4743A
1N4744A-G	15.0	14.25	15.75	14.0	17.00	700	0.25	5	11.4	1N4744A
1N4745A-G	16.0	15.20	16.80	16.0	15.50	700	0.25	5	12.2	1N4745A
1N4746A-G	18.0	17.10	18.90	20.0	14.00	750	0.25	5	13.7	1N4746A
1N4747A-G	20.0	19.00	21.00	22.0	12.50	750	0.25	5	15.2	1N4747A
1N4748A-G	22.0	20.90	23.10	23.0	11.50	750	0.25	5	16.7	1N4748A
1N4749A-G	24.0	22.80	25.20	25.0	10.50	750	0.25	5	18.2	1N4749A
1N4750A-G	27.0	25.65	28.35	35.0	9.50	750	0.25	5	20.6	1N4750A
1N4751A-G	30.0	28.50	31.50	40.0	8.50	1000	0.25	5	22.8	1N4751A
1N4752A-G	33.0	31.35	34.65	45.0	7.50	1000	0.25	5	25.1	1N4752A
1N4753A-G	36.0	34.20	37.80	50.0	7.00	1000	0.25	5	27.4	1N4753A
1N4754A-G	39.0	37.05	40.95	60.0	6.50	1000	0.25	5	29.7	1N4754A
1N4755A-G	43.0	40.85	45.15	70.0	6.00	1500	0.25	0.1	32.7	1N4755A
1N4756A-G	47.0	44.65	49.35	80.0	5.50	1500	0.25	0.1	35.8	1N4756A
1N4757A-G	51.0	48.45	53.55	95.0	5.00	1500	0.25	0.1	38.8	1N4757A
1N4758A-G	56.0	53.20	58.80	110.0	4.50	2000	0.25	0.1	42.6	1N4758A
1N4759A-G	62.0	58.90	65.10	125.0	4.00	2000	0.25	0.1	47.1	1N4759A
1N4760A-G	68.0	64.60	71.40	150.0	3.70	2000	0.25	0.1	51.7	1N4760A
1N4761A-G	75.0	71.25	78.75	175.0	3.30	2000	0.25	0.1	56.0	1N4761A
1N4762A-G	82.0	77.90	86.10	200.0	3.00	3000	0.25	0.1	62.2	1N4762A
1N4763A-G	91.0	86.45	95.55	250.0	2.80	3000	0.25	0.1	69.2	1N4763A
1N4764A-G	100.0	95.00	105.00	350.0	2.50	3000	0.25	0.1	76.0	1N4764A