



**Voidless Hermetically Sealed
Fast Recovery Glass Rectifiers**
Qualified per MIL-PRF-19500/359

*Qualified Levels:
JAN, JANTX,
and JANTXV*

DESCRIPTION

This Series of industry recognized voidless, hermetically sealed fast recovery glass rectifiers are military qualified to MIL-PRF-19500/359 and are ideal for high-reliability applications where a failure cannot be tolerated. They provide a working peak reverse voltage selection from 200 to 600 Volts with a 1.0 amp current rating. They are very robust in hard-glass construction and also use an internal metallurgical bond identified as "Category 1" for high-reliability applications. These devices are similar in ratings to the 1N5615 through 1N5619 series where surface mount MELF package configurations are also available by adding a "US" suffix (see separate data sheets).

Important: For the latest information, visit our website <http://www.microsemi.com>.

FEATURES

- Popular JEDEC registered 1N4942 through 1N4946 number series.
- Voidless hermetically sealed glass package.
- Triple-layer passivation.
- Internal "Category 1" metallurgical bonds.
- Working peak reverse voltage 200 to 600 volts.
- JAN, JANTX, and JANTXV qualifications are available per MIL-PRF-19500/359.
- RoHS compliant versions available (commercial grade only).

APPLICATIONS / BENEFITS

- Fast recovery 1 amp rectifiers 200 to 600 V.
- Military and other high reliability applications.
- General rectifier applications including bridges, half-bridges, catch diodes, etc.
- High forward surge current capability.
- Extremely robust construction.
- Low thermal construction.
- Controlled avalanche with peak power capability.
- Inherently radiation hard as described in Microsemi "MicroNote 050".

MAXIMUM RATINGS @ T_A = 25 °C unless otherwise specified

Parameters/Test Conditions	Symbol	Value	Unit
Junction and Storage Temperature	T _J and T _{STG}	-65 to +175	°C
Thermal Resistance Junction-to-Lead (Lead length = .375 in) also see Figure 1	R _{θJL}	38	°C/W
Thermal Resistance @ 10 ms heating time	R _{θJX}	115	°C/W
Average Rectified Forward Current @ T _A = +55°C @ T _A = +100°C	I _O	1.0 ⁽¹⁾⁽²⁾ 0.750 ⁽²⁾	Amps
Working Peak Reverse Voltage 1N4942 1N4944 1N4946	V _{RWM}	200 400 600	V
Maximum Forward Surge Current @ tp = 8.3 ms, I _O = .750 A, T _A = +55 °C	I _{FSM}	15	Amps
Solder Temperature @ 10 s	T _{SP}	260	°C

- Notes:**
1. Derate linearly from 1.0 A at T_A = +55 °C to 0.75 A at +100 °C. Derate linearly from 0.75 A to 0 A between +100 °C and +175 °C.
 2. For the 1 amp rating at 55 °C ambient or 0.75 amp rating at 100 °C ambient, these I_O ratings are for thermal (PC boards or other) mounting methods where thermal resistance from mounting point to ambient is still sufficiently controlled where T_{J(MAX)} in 1.3 is not exceeded. This equates to R_{θJX} ≤ 115 °C/W as shown.

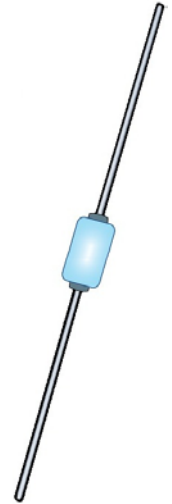

"A" Package

MSC – Lawrence
6 Lake Street,
Lawrence, MA 01841
Tel: 1-800-446-1158 or
(978) 620-2600
Fax: (978) 689-0803

MSC – Ireland
Gort Road Business Park,
Ennis, Co. Clare, Ireland
Tel: +353 (0) 65 6840044
Fax: +353 (0) 65 6822298

Website:
www.microsemi.com

MECHANICAL and PACKAGING

- CASE: Hermetically sealed voidless hard glass with tungsten slugs.
- TERMINALS: Tin/lead or RoHS compliant matte/tin (commercial grade only) over nickel plate over copper.
- MARKING: Body painted with part number.
- POLARITY: Cathode indicated by band.
- TAPE & REEL option: Standard per EIA-296. Consult factory for quantities.
- WEIGHT: Approximately 340 milligrams.
- See [Package Dimensions](#) on last page.

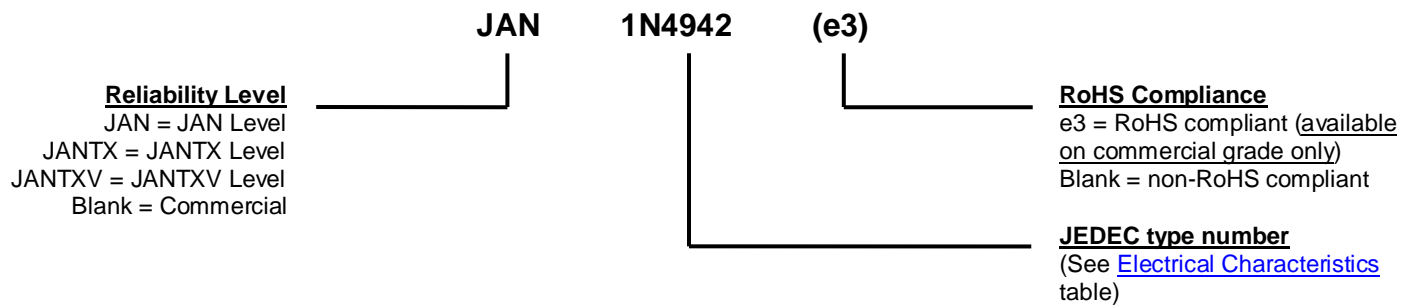
PART NOMENCLATURE

SYMBOLS & DEFINITIONS

Symbol	Definition
C	Capacitance: The capacitance in pF at a frequency of 1 MHz and specified voltage
I_R	Reverse Current: The maximum reverse (leakage) current that will flow at the specified voltage and temperature.
t_{rr}	Reverse Recovery Time: The time interval between the instant the current passes through zero when changing from the forward direction to the reverse direction and a specified decay point after a peak reverse current occurs.
V_F	Maximum Forward Voltage: The maximum forward voltage the device will exhibit at a specified current.
$V_{(BR)}$	Minimum Breakdown Voltage: The minimum voltage the device will exhibit at a specified current.
V_{RWM}	Working Peak Reverse Voltage: The maximum peak voltage that can be applied over the operating temperature range excluding all transient voltages (ref JESD282-B). Also sometimes known as PIV.
C	Capacitance: The capacitance in pF at a frequency of 1 MHz and specified voltage.

ELECTRICAL CHARACTERISTICS

TYPE	MAXIMUM FORWARD VOLTAGE V_{FM} @ $I_{FM} = 1A$		MINIMUM BREAKDOWN VOLTAGE $V_{(BR)}$	MAXIMUM REVERSE CURRENT I_R @ V_{RWM}		MAXIMUM JUNCTION CAPACITANCE C_J @ $V_R = 12V$	MAXIMUM REVERSE RECOVERY (NOTE 2) t_{rr}
	Volts		Volts	μA		pF	ns
	25°C	150°C		25°C	150°C		
1N4942	0.6 – 1.3	0.6 – 1.5	220	1.0	200	45	150
1N4944	0.6 – 1.3	0.6 – 1.5	440	1.0	200	35	150
1N4946	0.6 – 1.3	0.6 – 1.5	660	1.0	200	25	250

NOTE 1: $T_A = 100^\circ C$, 8.3 ms surges

NOTE 2: $I_F = 0.5 A$, $I_{RM} = 1 A$, $I_{R(REC)} = 0.250 A$

GRAPHS

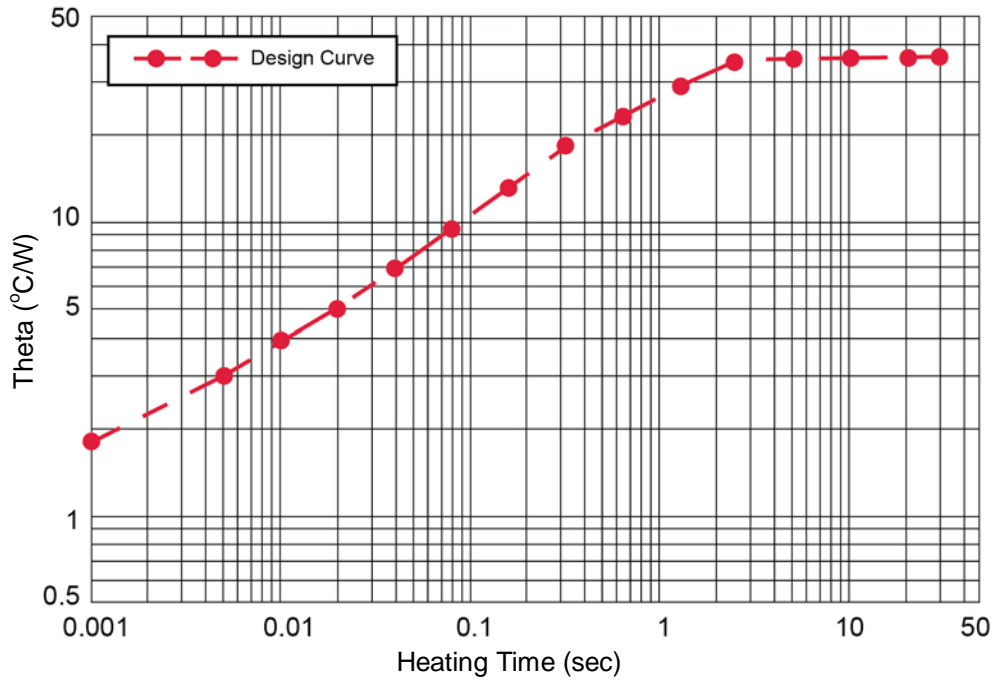

FIGURE 1
Maximum Thermal Impedance

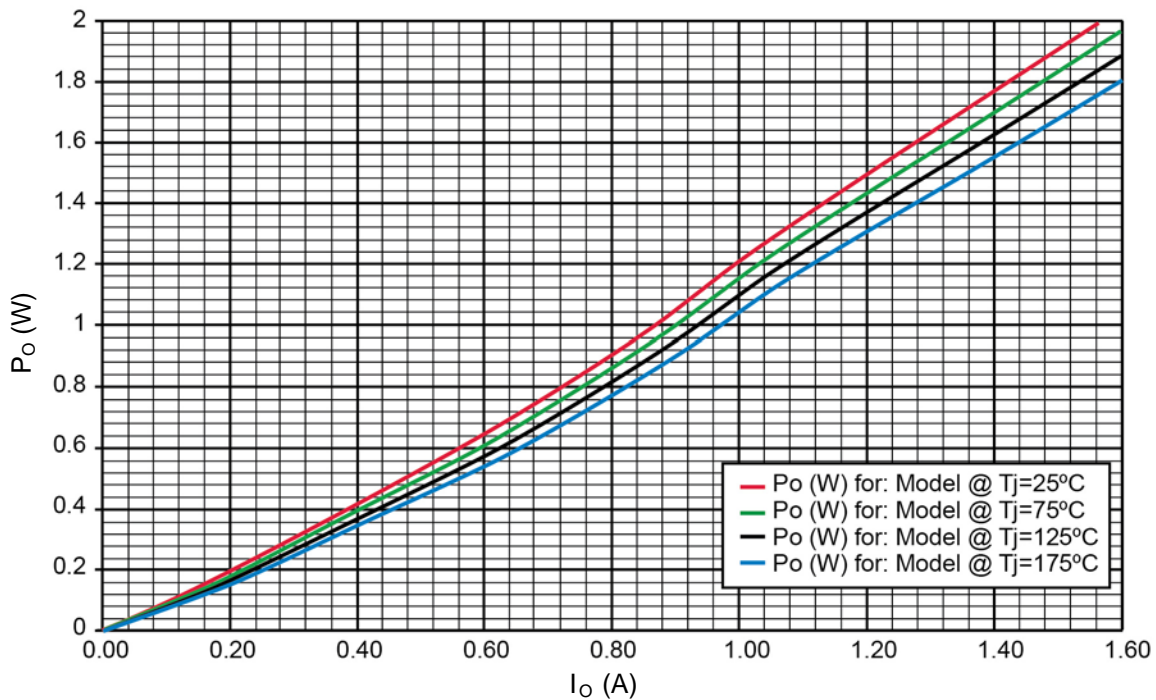

FIGURE 2
Rectifier Power vs I_o (Average Forward Current)

GRAPHS (continued)

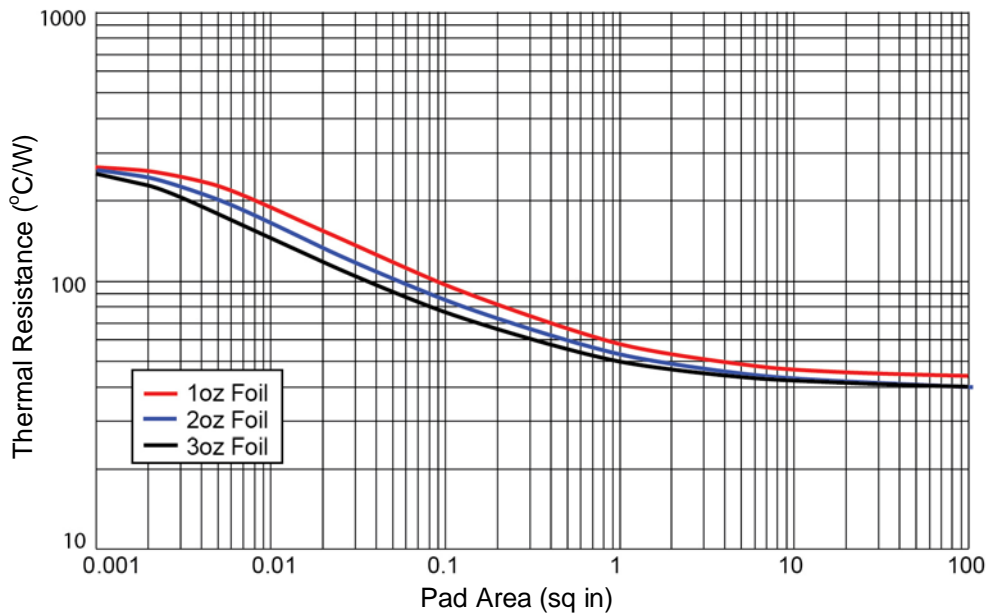

FIGURE 3
Thermal Resistance vs FR4 Pad Area At Ambient
 PCB horizontal (for each pad) with 1, 2, and 3 oz copper

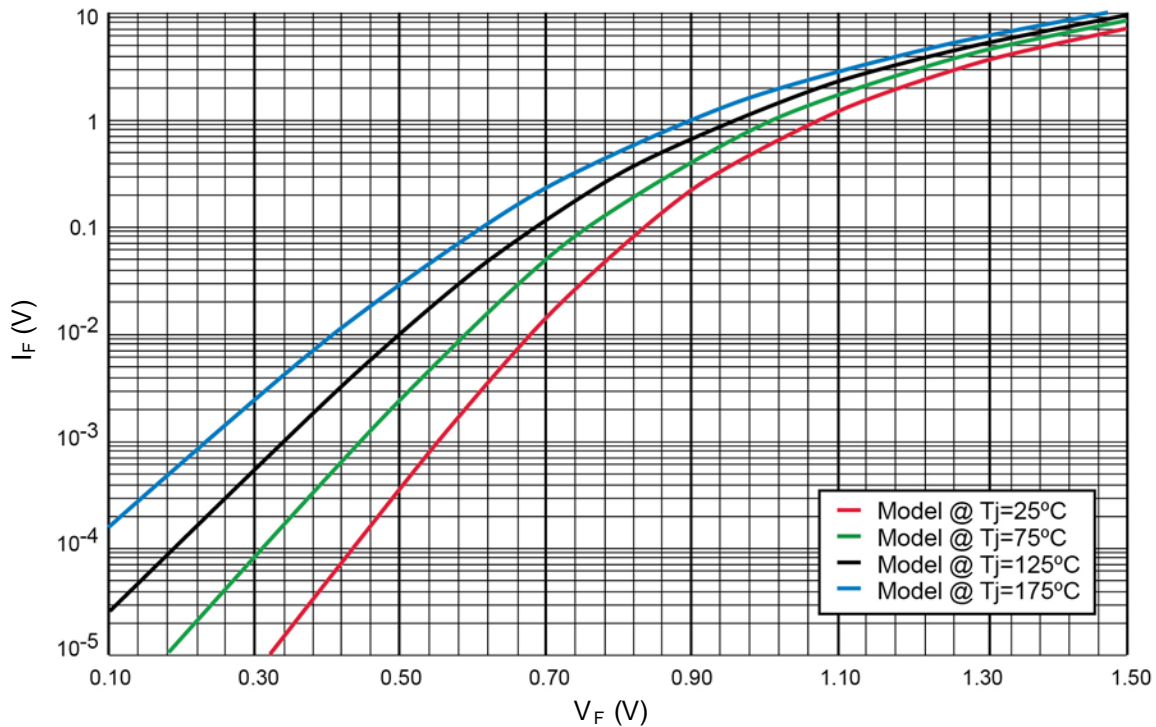
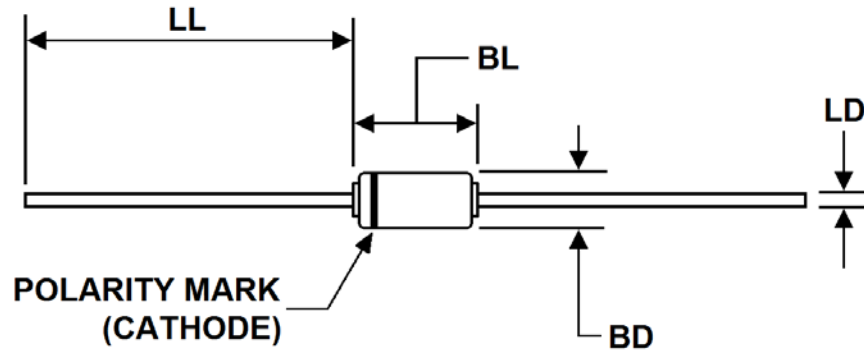

FIGURE 4
Forward Voltage vs Forward Current

PACKAGE DIMENSIONS

NOTES:

1. Dimensions are in inches.
2. Millimeters equivalents are given for general information only.
3. Dimension BD shall be measured at the largest diameter.
4. Dimension BL shall include the entire body including slugs and sections of the lead over which the diameter is uncontrolled. This uncontrolled area is defined as the zone between the edge of the diode body and extending .050 inch (1.27 mm) onto the leads.
5. In accordance with ASME Y14.5M, diameters are equivalent to Φ symbology.

Ltr	DIMENSIONS				Notes
	INCH		MILLIMETERS		
	Min	Max	Min	Max	
BD	0.065	0.150	1.65	3.81	3, 4
BL	0.140	0.250	3.56	6.35	4
LD	0.027	0.033	0.69	0.84	
LL	1.00	1.50	25.4	38.1	