

Silicon Rectifiers

1N1199A-1N1206A

1N1199RA-1N1206RA

1N3670A-1N3673A

1N5331

These diffused junction rectifiers are designed specifically to provide high performance for applications up to 22 amperes Average Forward Current in single-phase applications with repetitive peak reverse voltages of 50 through 1200 volts. High junction temperature rating plus low forward drop and thermal impedance permit high current operation with minimum space requirements.

General Electric research, advance development and product design have resulted in a highly efficient rectifying junction. This feature, plus a mechanical design employing high-temperature hard solders and welds for all internal and external joints and seals, which eliminates common sources of thermal fatigue failure, have produced a silicon rectifier with outstanding reliability under all operating conditions.

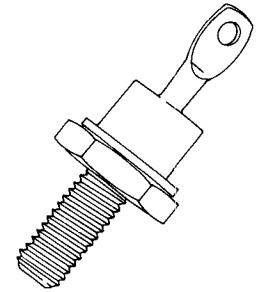

FEATURES:

- High Voltage
- Ratings up to 200°C Junction Temperature
- Popular DO-4 Outline
- Uses Hard Solders for Thermal Fatigue Protection
- Transient Voltage Ratings 200 Volts Above PRV Ratings

MAXIMUM ALLOWABLE RATINGS

Types	Repetitive Peak Reverse Voltage, $V_{RM(rep)}$ ⁽¹⁾	RMS Voltage	DC Blocking Voltage ⁽²⁾	Non-Repetitive Peak Reverse Voltage, $V_{RM(non-rep)}$	Full-Load Reverse Current (full-cycle avg., 150°C T_C , 1 ϕ), $I_{R(AV)}$
	Volts*	Volts*	Volts*	Volts*	Milliamperes*
1N1199A, RA	50	35	50	100	3.0
1N1200A, RA	100	70	100	200	2.5
1N1201A, RA	150	105	150	300	2.25
1N1202A, RA	200	140	200	350	2.0
1N1203A, RA	300	210	300	450	1.75
1N1204A, RA	400	280	400	600	1.5
1N1205A, RA	500	350	500	700	1.25
1N1206A, RA	600	420	600	800	1.0
1N3670A, RA	700	490	700	900	0.9
1N3671A, RA	800	560	800	1000	0.8
1N3672A, RA	900	650	900	1100	0.7
1N3673A, RA	1000	700	1000	1200	0.6
1N5331, R	1200	840	1200	1400	0.5

Average Forward Current ($T_C = 150^\circ\text{C}$, single-phase)	12 Amperes*
Peak One-Cycle Surge Current (non-repetitive), I_{FM} (surge)	240 Amperes*
Minimum I^2t Rating (for times $> .0008$ sec. and $< .0083$ sec., non-recurrent)	60 Ampere ² seconds
Maximum Full-Load Voltage Drop ($T_C = 150^\circ\text{C}$, single-phase, full-cycle avg.)	0.55 Volts*
Maximum Thermal Resistance, θ_{J-C}	2.5°C/Watt
Storage and Operating Junction Temperature, T_J	-65°C to +200°C*
Stud Torque	12 Lb-in (Min), 15 Lb-in (Max)* 14 Kg-cm (Min), 17.5 Kg-cm (Max)*

NOTES:

- (1) Maximum voltages apply with a heatsink thermal resistance of 22°C/watt, or less, at maximum rated junction temperature.
- (2) Maximum voltages apply with a heatsink thermal resistance 7°C/watt, or less, at maximum rated junction temperature.
- (3) Case temperature, T_C , is measured at the center of any one of the hex flats.

*Indicates values included in JEDEC Type Number Registration.

1N1199A-1N1206A
1N1199RA-1N1206RA
1N3670A-1N3673A
1N5331

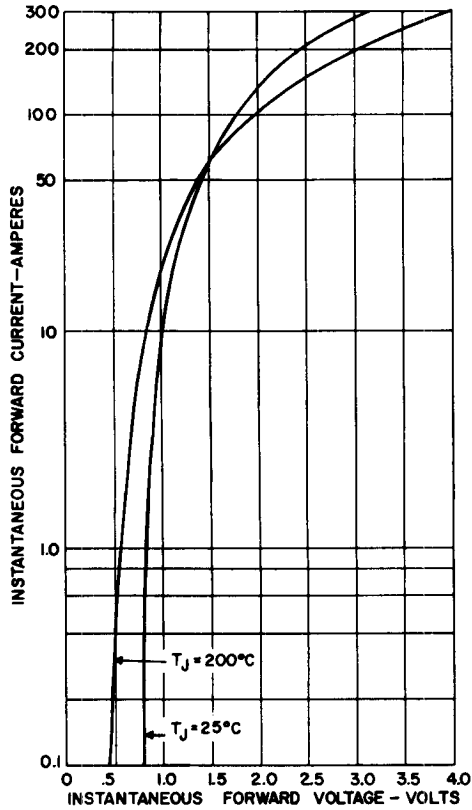

1. MAXIMUM FORWARD CHARACTERISTICS

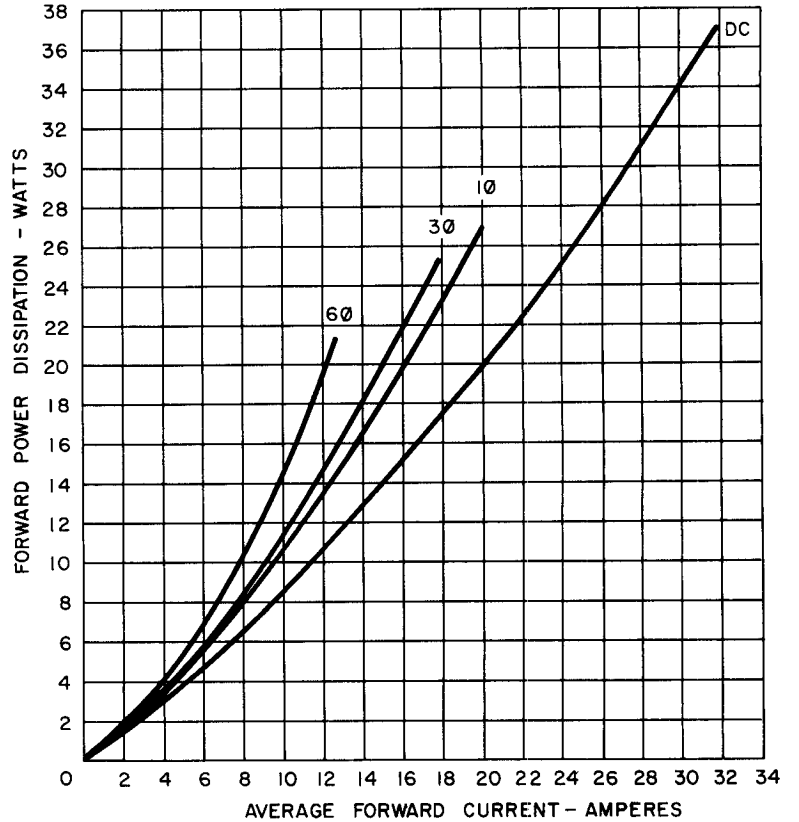

2. FORWARD POWER AS A FUNCTION OF AVERAGE FORWARD CURRENT ($T_J = +200^\circ\text{C}$)

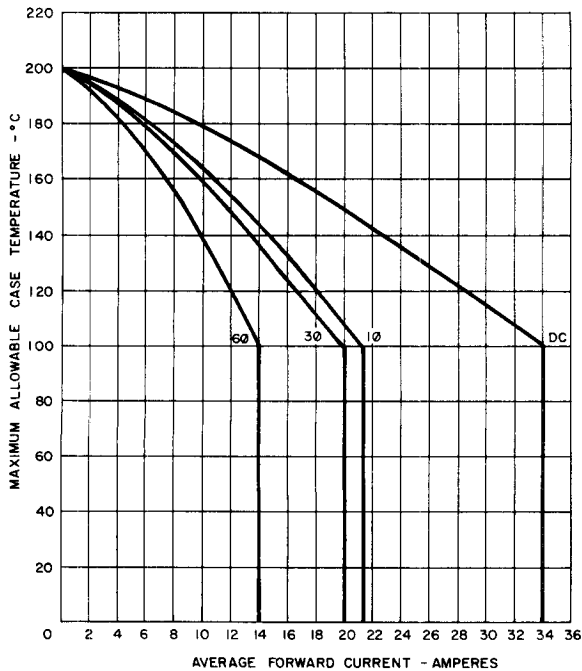

3. MAXIMUM CASE TEMPERATURE VS. AVERAGE FORWARD CURRENT

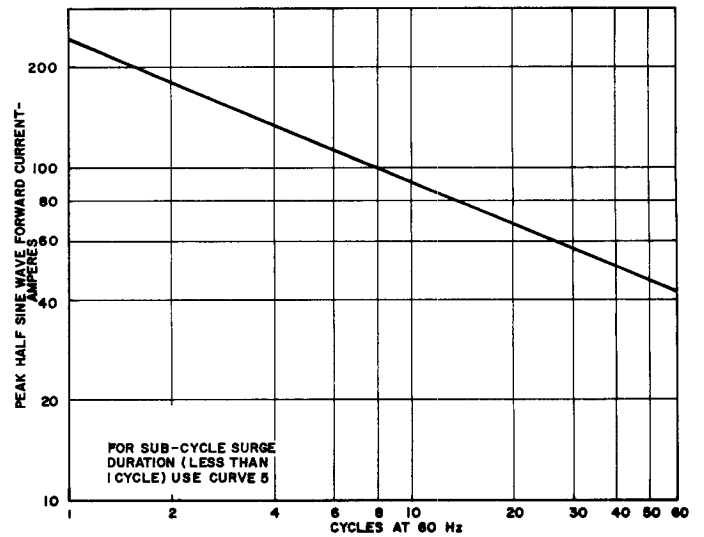

4. MAXIMUM SURGE CURRENT FOLLOWING RATED LOAD CONDITIONS

1N1199A-1N1206A
1N1199RA-1N1206RA
1N3670A-1N3673A
1N5331

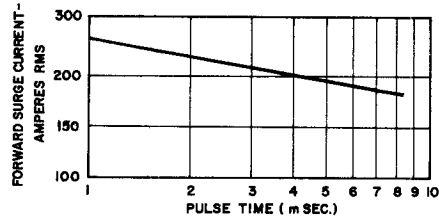
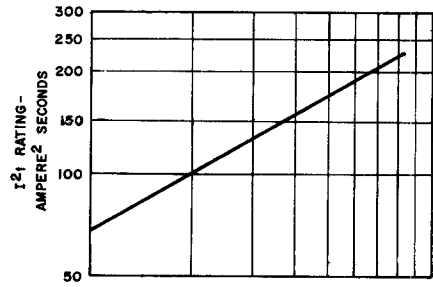

5. SUBCYCLE SURGE FORWARD CURRENT AND I²t RATING FOLLOWING RATED LOAD CONDITIONS

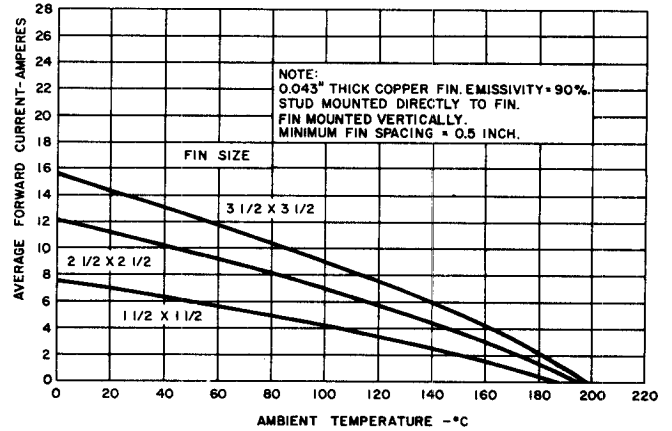
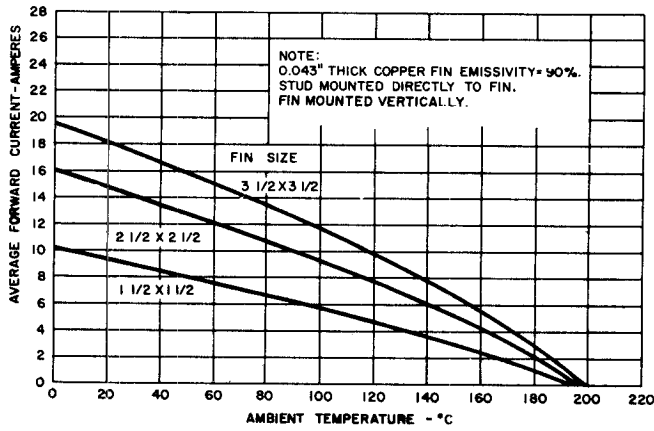

6. REQUIRED FIN SIZE — FREE CONVECTION, SINGLE FIN, UNIMPEDED RADIATION

7. REQUIRED FIN SIZE — FREE CONVECTION, IMPEDED RADIATION

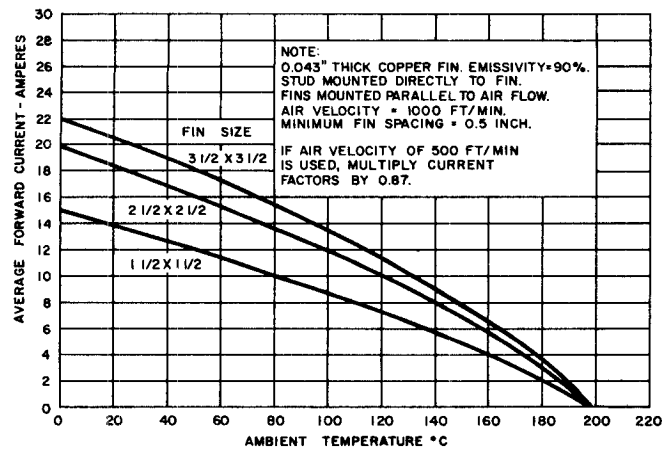

8. REQUIRED FIN SIZE — FORCED CONVECTION, IMPEDED RADIATION

TO USE GRAPHS 6, 7 AND 8

1. Enter graph at vertical axis with desired current multiplied by proper current factor:
DC-0.80 3φ-1.15
1φ-1.00 6φ-1.40
2. Intercept desired fin curve
3. Read on horizontal axis the maximum allowable ambient temperature

1N1199A-1N1206A
1N1199RA-1N1206RA
1N3670A-1N3673A
1N5331

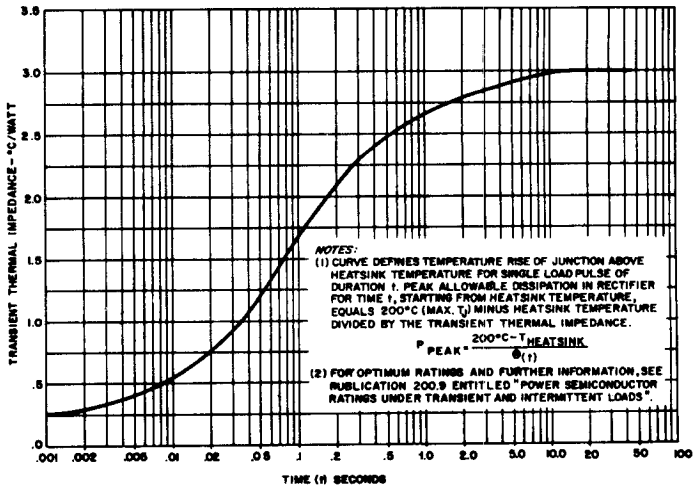

9. MAXIMUM TRANSIENT THERMAL IMPEDANCE — JUNCTION TO HEATSINK

OUTLINE DRAWING

INSULATING HARDWARE KIT *

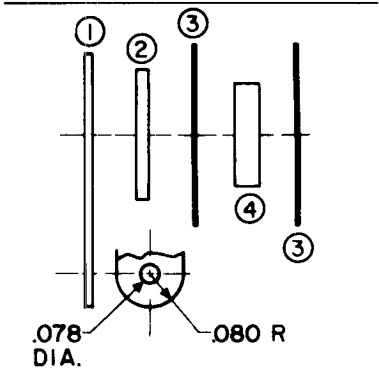

- ① COPPER TERMINAL, .016 THICK, TIN PLATED
- ② BRASS WASHER, .035 THICK NICKEL PLATED
- ③ MICA WASHERS, TWO, .625 O.D., .204 I.D., .005 THICK
- ④ TEFLON WASHER, .270 O.D., .204 I.D., .050 THICK

* AVAILABLE UPON REQUEST

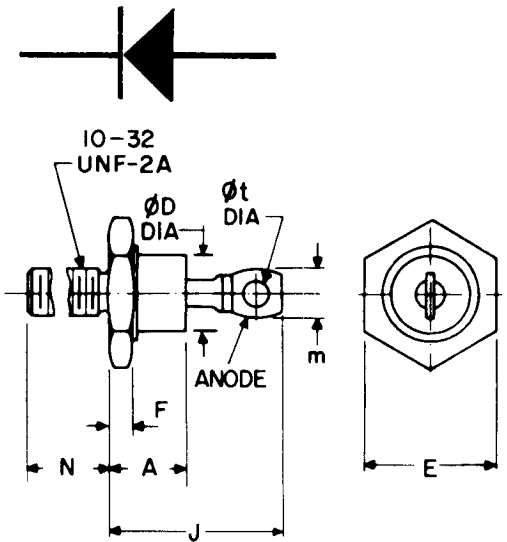

COMPLIES WITH EIA REGISTERED OUTLINE DO-4

SYMBOL	INCHES		MILLIMETERS		NOTES
	MIN.	MAX.	MIN.	MAX.	
A		.405		10.29	
φD		.424		10.77	
E	.424	.437	10.77	11.10	
F	.075	.175	1.91	4.45	
J		.800		20.32	
m		.250		6.35	1
N	.422	.453	10.72	11.51	
φt	.060		1.52		
W					2

NOTES:

- 1. Angular orientation of this terminal is undefined.
- 2. 10-32 UNF-2A. Maximum pitch diameter of plated threads shall be basic pitch diameter (.1697", 4.29 MM). Ref: (Screw thread standards for Federal Services 1957) Handbook H28, P1.