

5 W SILICON ZENER DIODES

FEATURES

- * Low cost
- * Low leakage
- * Low forward voltage drop
- * High current capability

MECHANICAL DATA

- * Case: Molded plastic
- * Epoxy: Device has UL flammability classification 94V-O
- * Lead: MIL-STD-202E method 208C guaranteed
- * Mounting position: Any

MAXIMUM RATINGS AND ELECTRICAL CHARACTERISTICS

Ratings at 25°C ambient temperature unless otherwise specified.
Single phase, half wave, 60 Hz, resistive or inductive load.
For capacitive load, derate current by 20%.



DO-15

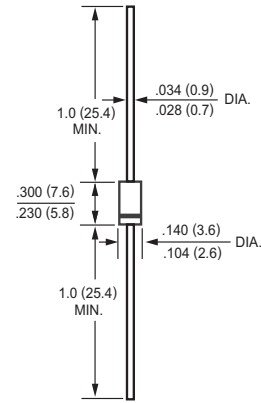

Dimensions in inches and (millimeters)

Absolute Maximum Ratings (Rating at 25°C ambient temperature unless otherwise specified)

Parameter	Symbol	Value	Unit
DC Power Dissipation @ $T_L = 75^\circ\text{C}$ ¹⁾	P_D	5	W
Junction and Storage Temperature Range	T_j, T_{stg}	- 65 to + 200	°C

¹⁾ T_L = Lead temperature at 3/8" (9.5 mm) from body

Characteristics at $T_a = 25^\circ\text{C}$

Parameter	Symbol	Max.	Unit
Forward Voltage at $I_F = 1\text{ A}$	V_F	1.2	V

Electrical Characteristics (Rating at 25 °C ambient temperature unless otherwise specified)

Type	Zener Voltage ¹⁾				Zener Impedance				Leakage Current		Maximum DC Zener Current
	V _{Znom} (V)	V _{ZT}		at I _{ZT}	Z _{ZT}	at I _{ZT}	Z _{ZK}	at I _{ZK}	I _R	at V _R	I _{ZM}
		Min.(V)	Max.(V)	(mA)	Max.(Ω)	(mA)	Max.(Ω)	(mA)	Max.(μA)	(V)	(mA)
1N5333B	3.3	3.14	3.47	380	3.0	380	400	1	300	1.0	1440
1N5334B	3.6	3.42	3.78	350	2.5	350	500	1	150	1.0	1320
1N5335B	3.9	3.71	4.10	320	2.0	320	500	1	50	1.0	1220
1N5336B	4.3	4.09	4.52	290	2.0	290	500	1	10	1.0	1100
1N5337B	4.7	4.47	4.94	260	2.0	260	450	1	5.0	1.0	1010
1N5338B	5.1	4.85	5.35	240	1.5	240	400	1	1	1	930
1N5339B	5.6	5.32	5.88	220	1	220	400	1	1	2	856
1N5340B	6	5.7	6.3	200	1	200	300	1	1	3	790
1N5341B	6.2	5.89	6.51	200	1	200	200	1	1	3	765
1N5342B	6.8	6.46	7.14	175	1	175	200	1	10	5.2	700
1N5343B	7.5	7.13	7.87	175	1.5	175	200	1	10	5.7	630
1N5344B	8.2	7.79	8.61	150	1.5	150	200	1	10	6.2	580
1N5345B	8.7	8.27	9.13	150	2	150	200	1	10	6.6	545
1N5346B	9.1	8.65	9.55	150	2	150	150	1	7.5	6.9	520
1N5347B	10	9.5	10.5	125	2	125	125	1	5	7.6	475
1N5348B	11	10.45	11.55	125	2.5	125	125	1	5	8.4	430
1N5349B	12	11.4	12.6	100	2.5	100	125	1	2	9.1	395
1N5350B	13	12.35	13.65	100	2.5	100	100	1	1	9.9	365
1N5351B	14	13.3	14.7	100	2.5	100	75	1	1	10.6	340
1N5352B	15	14.25	15.75	75	2.5	75	75	1	1	11.5	315
1N5353B	16	15.2	16.8	75	2.5	75	75	1	1	12.2	295
1N5354B	17	16.15	17.85	70	2.5	70	75	1	0.5	12.9	280
1N5355B	18	17.1	18.9	65	2.5	65	75	1	0.5	13.7	265
1N5356B	19	18.05	19.95	65	3	65	75	1	0.5	14.4	250
1N5357B	20	19	21	65	3	65	75	1	0.5	15.2	237
1N5358B	22	20.9	23.1	50	3.5	50	75	1	0.5	16.7	216
1N5359B	24	22.8	25.2	50	3.5	50	100	1	0.5	18.2	198
1N5360B	25	23.75	26.25	50	4	50	110	1	0.5	19	190
1N5361B	27	25.65	28.35	50	5	50	120	1	0.5	20.6	176
1N5362B	28	26.6	29.4	50	6	50	130	1	0.5	21.2	170
1N5363B	30	28.5	31.5	40	8	40	140	1	0.5	22.8	158
1N5364B	33	31.35	34.65	40	10	40	150	1	0.5	25.1	144
1N5365B	36	34.2	37.8	30	11	30	160	1	0.5	27.4	132
1N5366B	39	37.05	40.95	30	14	30	170	1	0.5	29.7	122
1N5367B	43	40.85	45.15	30	20	30	190	1	0.5	32.7	110
1N5368B	47	44.65	49.35	25	25	25	210	1	0.5	35.8	100
1N5369B	51	48.45	53.55	25	27	25	230	1	0.5	38.8	93
1N5370B	56	53.2	58.8	20	35	20	280	1	0.5	42.6	86
1N5371B	60	57	63	20	40	20	350	1	0.5	45.5	79
1N5372B	62	58.9	65.1	20	42	20	400	1	0.5	47.1	76
1N5373B	68	64.6	71.4	20	44	20	500	1	0.5	51.7	70
1N5374B	75	71.25	78.75	20	45	20	620	1	0.5	56	63
1N5375B	82	77.9	86.1	15	65	15	720	1	0.5	62.2	58
1N5376B	87	82.65	91.35	15	75	15	760	1	0.5	66	54.5
1N5377B	91	86.45	95.55	15	75	15	760	1	0.5	69.2	52.5
1N5378B	100	95	105	12	90	12	800	1	0.5	76	47.5
1N5379B	110	104.5	115.5	12	125	12	1000	1	0.5	83.6	43
1N5380B	120	114	126	10	170	10	1150	1	0.5	91.2	39.5
1N5381B	130	123.5	136.5	10	190	10	1250	1	0.5	98.8	36.6
1N5382B	140	133	147	8	230	8	1500	1	0.5	106	34
1N5383B	150	142.5	157.5	8	330	8	1500	1	0.5	114	31.6
1N5384B	160	152	168	8	350	8	1650	1	0.5	122	29.4
1N5385B	170	161.5	178.5	8	380	8	1750	1	0.5	129	28
1N5386B	180	171	189	5	430	5	1750	1	0.5	137	26.4
1N5387B	190	180.5	199.5	5	450	5	1850	1	0.5	144	25
1N5388B	200	190	210	5	480	5	1850	1	0.5	152	23.6

¹⁾ Suffix "A" indicates ± 10% tolerance, Suffix "B" indicates ± 5% tolerance

RATING AND CHARACTERISTICS CURVES (1N5333B THRU 1N5388B)

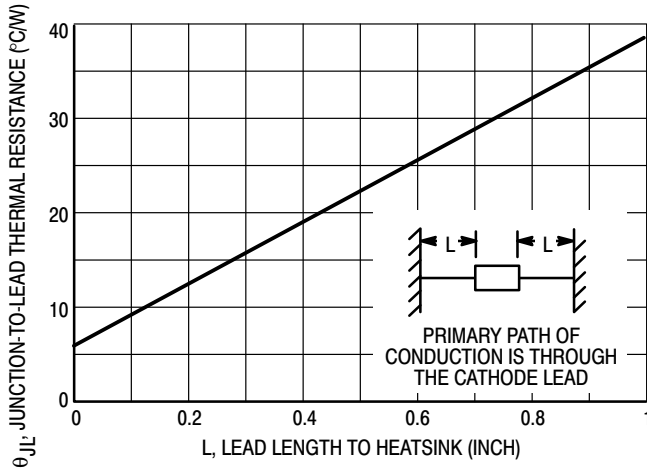

Figure 1. Typical Thermal Resistance

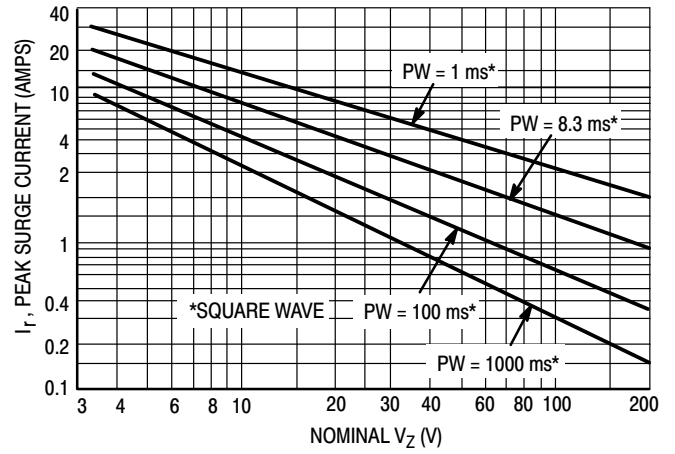

Figure 2. Maximum Non-Repetitive Surge Current versus Nominal Zener Voltage

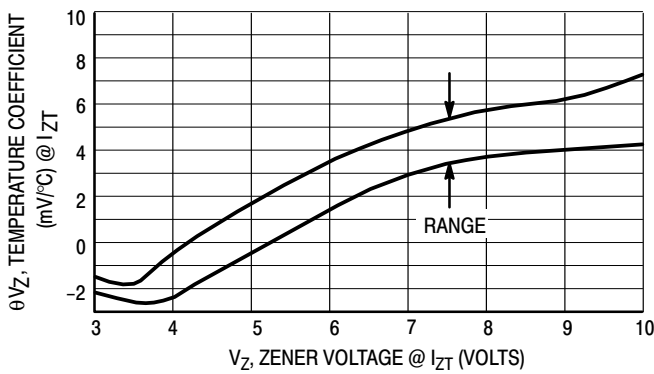

Figure 3. Temperature Coefficient-Range for Units 3 to 10 Volts

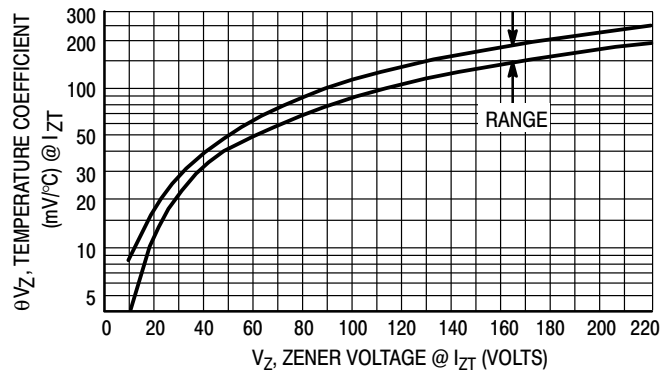

Figure 4. Temperature Coefficient-Range for Units 10 to 220 Volts

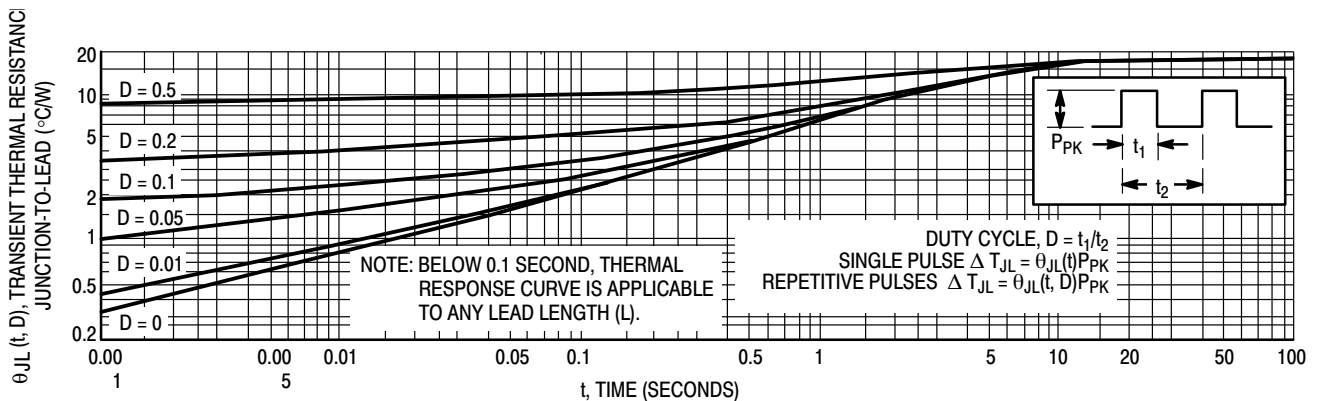

Figure 5. Typical Thermal Response
L, Lead Length = 3/8 Inch

RATING AND CHARACTERISTICS CURVES (1N5333B THRU 1N5388B)

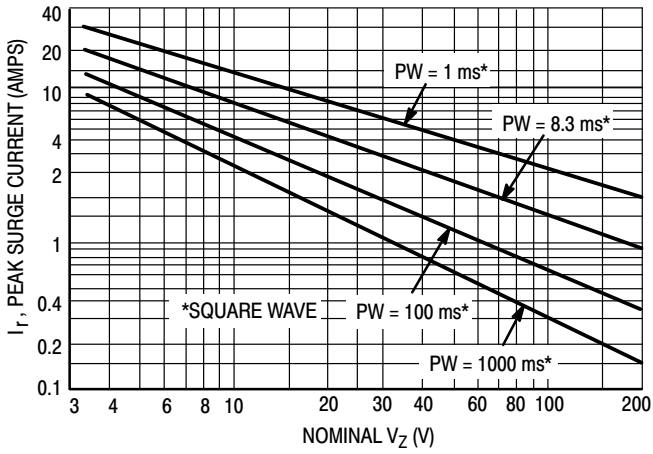

Figure 6. Maximum Non-Repetitive Surge Current versus Nominal Zener Voltage

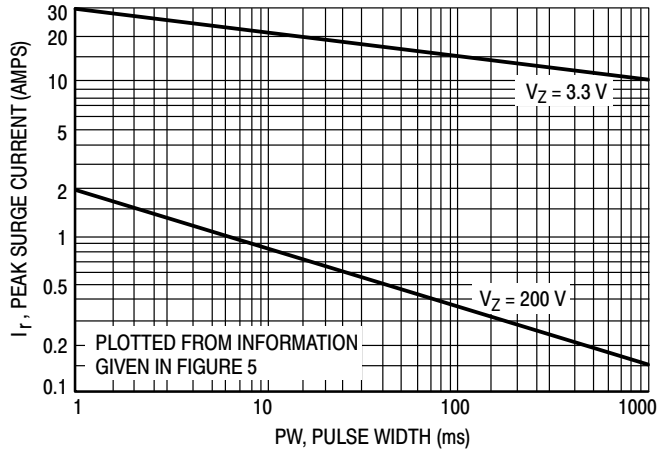
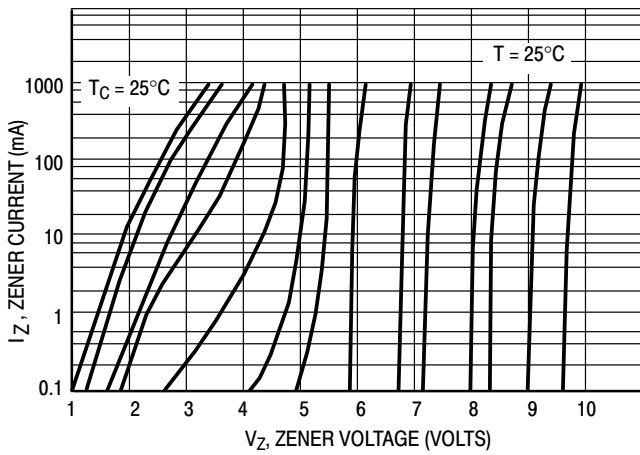
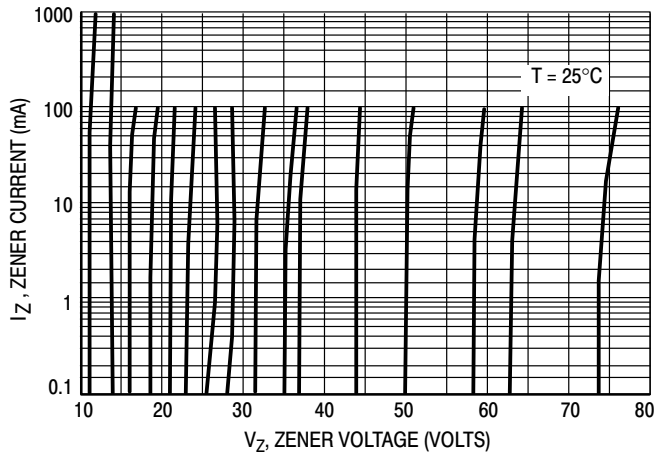

Figure 7. Peak Surge Current versus Pulse Width



**Figure 8. Zener Voltage versus Zener Current
 $V_z = 3.3$ thru 10 Volts**



**Figure 9. Zener Voltage versus Zener Current
 $V_z = 11$ thru 75 Volts**

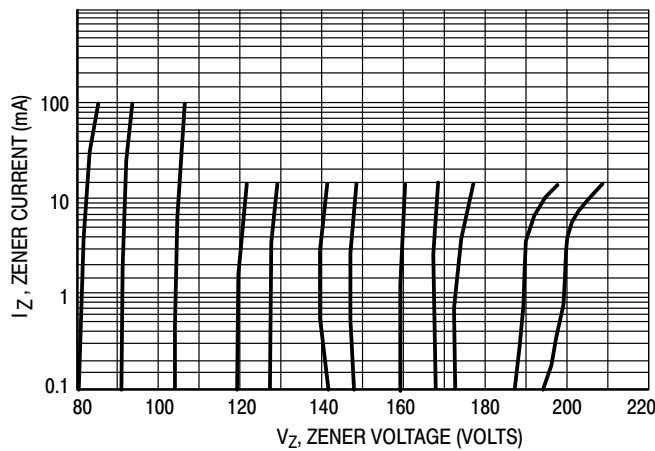

**Figure 10. Zener Voltage versus Zener Current
 $V_z = 82$ thru 200 Volts**



Attachment information about 1N53XXB

1. Internal Circuit



2. Marking on the body

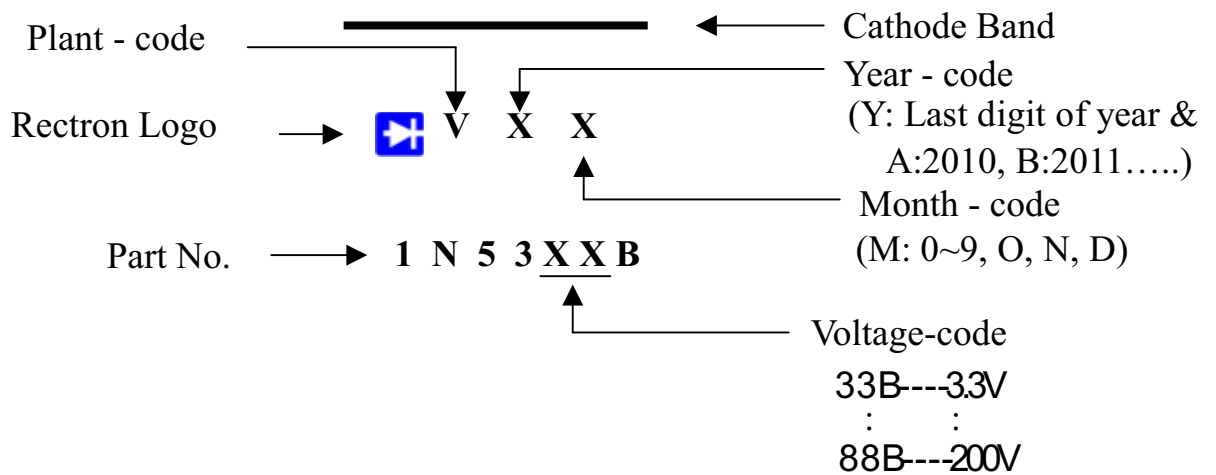

DISCLAIMER NOTICE

Rectron Inc reserves the right to make changes without notice to any product specification herein, to make corrections, modifications, enhancements or other changes. Rectron Inc or anyone on its behalf assumes no responsibility or liability for any errors or inaccuracies. Data sheet specifications and its information contained are intended to provide a product description only. "Typical" parameters which may be included on RECTRON data sheets and/ or specifications can and do vary in different applications and actual performance may vary over time. Rectron Inc does not assume any liability arising out of the application or use of any product or circuit.

Rectron products are not designed, intended or authorized for use in medical, life-saving implant or other applications intended for life-sustaining or other related applications where a failure or malfunction of component or circuitry may directly or indirectly cause injury or threaten a life without expressed written approval of Rectron Inc. Customers using or selling Rectron components for use in such applications do so at their own risk and shall agree to fully indemnify Rectron Inc and its subsidiaries harmless against all claims, damages and expenditures.

PACKAGING OF DIODE AND BRIDGE RECTIFIERS

BULK PACK

PACKAGE	PACKING CODE	EA PER BOX	INNER BOX SIZE (mm)	CARTON SIZE (mm)	EA PER CARTON	GROSS WEIGHT(Kg)
DO-15	-B	500	194*84*21	415*220*255	25,000	12.74

REEL PACK

PACKAGE	PACKING CODE	EA PER REEL	EA PER INNER BOX	COMPONENT SPACE (mm)	TAPE SPACE (mm)	REEL DIA (mm)	CARTON SIZE (mm)	EA PER CARTON	GROSS WEIGHT(Kg)
DO-15	-T	4,000	4,000	5.0	52	330	355*350*335	16,000	10.05

AMMO PACK

PACKAGE	PACKING CODE	REEL (EA)	COMPONENT SPACE(mm)	TAPE SPACE (mm)	BOX SIZE (mm)	CARTON SIZE(mm)	CARTON (EA)	GROSS WEIGHT (Kg)
DO-15	-F	1,500	5.0	52	255*73*100	400*268*225	15,000	8.8