

1N5817WS~1N5819WS

1 A Surface Mount Schottky Barrier Diode

PINNING

PIN	DESCRIPTION
1	Cathode
2	Anode

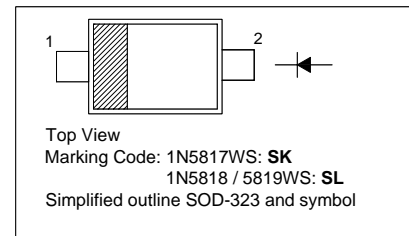

Absolute Maximum Ratings ($T_a = 25^\circ\text{C}$)

Parameter	Symbol	Value	Unit
Reverse Voltage	V_R	20	V
		30	
		40	
Average Forward Rectified Current	$I_{F(AV)}$	1	A
Non-Repetitive Peak Forward Surge Current ($t = 8.3 \text{ ms}$)	I_{FSM}	9	A
Power Dissipation	P_{tot}	450	mW
Operating Temperature Range	T_j	- 55 to + 125	$^\circ\text{C}$
Storage Temperature Range	T_{stg}	- 55 to + 125	$^\circ\text{C}$

Characteristics at $T_a = 25^\circ\text{C}$

Parameter	Symbol	Min.	Max.	Unit
Reverse Breakdown Voltage at $I_R = 1 \text{ mA}$	$V_{(BR)R}$	20	-	V
		30	-	
		40	-	
Forward Voltage at $I_F = 1 \text{ A}$	V_F	-	0.45	V
		-	0.55	
		-	0.6	
at $I_F = 3 \text{ A}$	V_F	-	0.75	V
		-	0.875	
		-	0.9	
Reverse Voltage Leakage Current at $V_R = 20 \text{ V}$	I_R	-	1	mA
at $V_R = 30 \text{ V}$		-	1	
at $V_R = 40 \text{ V}$		-	1	
Total Capacitance at $V_R = 4 \text{ V}$, $f = 1 \text{ MHz}$	C_{tot}	-	120	pF

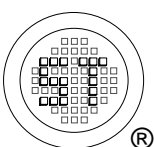

SEMTECH ELECTRONICS LTD.
 Subsidiary of Sino-Tech International (BVI) Limited



Fig. 1 - Forward Current Derating Curve

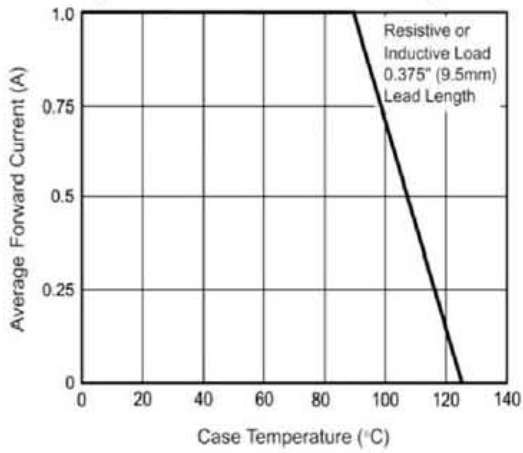

Fig. 2 - Maximum Non-Repetitive Peak Forward Surge Current

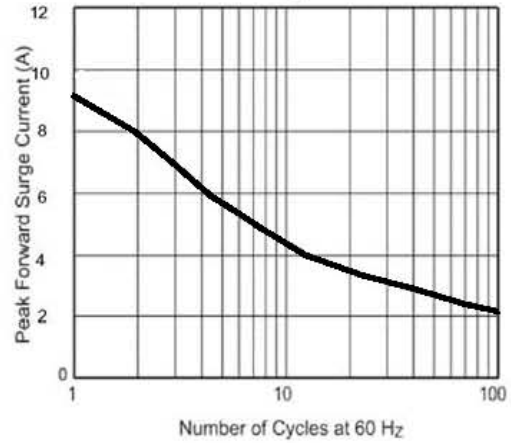

Fig. 3 - Typical Instantaneous Forward Characteristics

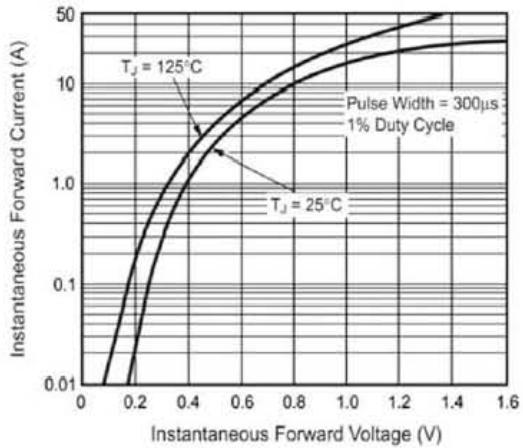
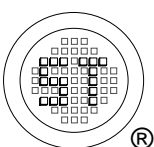
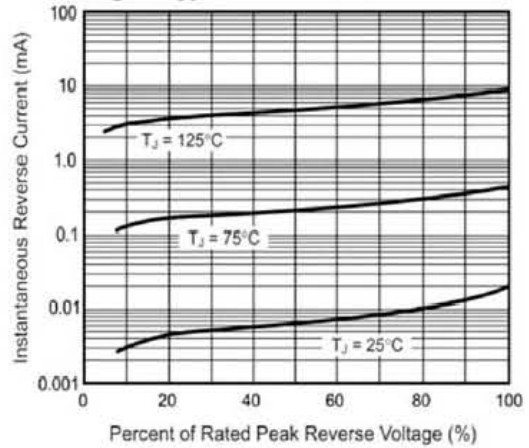

Fig. 4 - Typical Reverse Characteristics



1N5817WS~1N5819WS

PACKAGE OUTLINE

Plastic surface mounted package; 2 leads

SOD-323

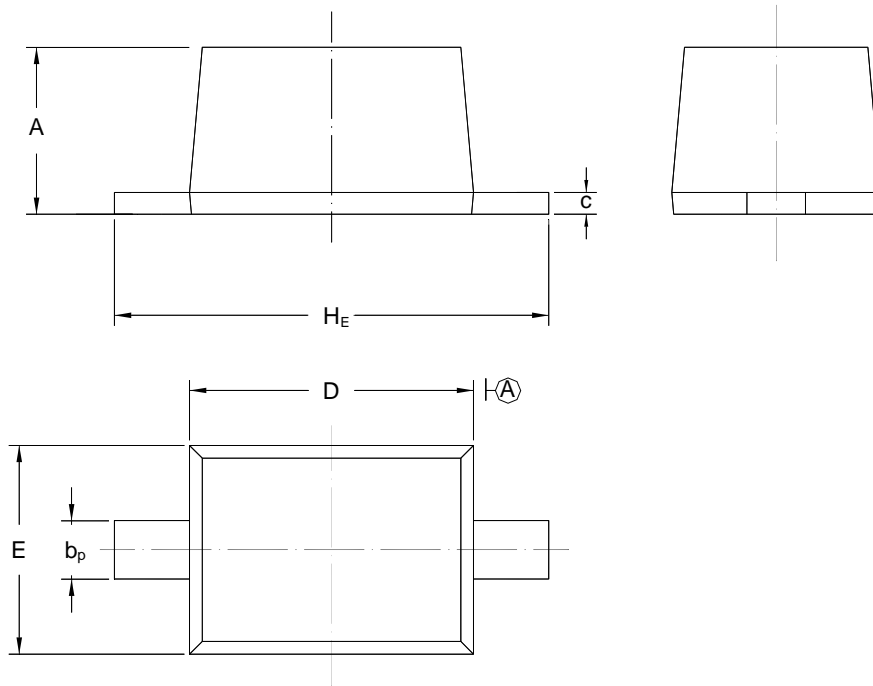

UNIT	A	b _p	C	D	E	H _E
mm	1.10 0.80	0.40 0.25	0.15 0.10	1.80 1.60	1.35 1.15	2.80 2.30

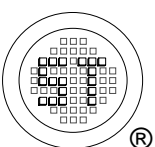

SEMTECH ELECTRONICS LTD.
Subsidiary of Sino-Tech International (BVI) Limited



Dated: 17/01/2013 Rev: 02