



1N5819

DIODE

SCHOTTKY BARRIER DIODE

FEATURES

- * Schottky barrier chip
- * Low power loss, high efficiency.
- * Low forward voltage drop.
- * High surge current capability.
- * For use in low voltage, high frequency inverters, free wheeling diode, and polarity protection applications.

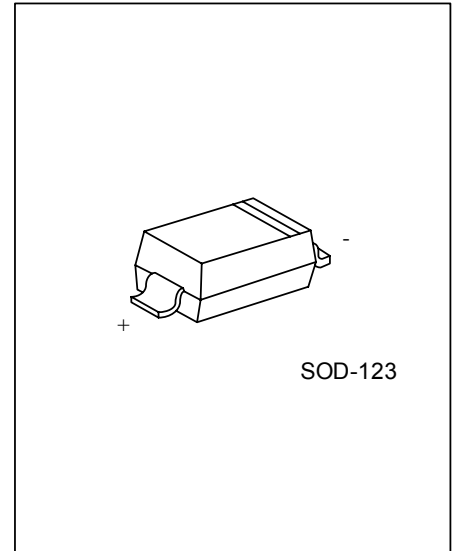

*Pb-free plating product number: 1N5819L

ORDERING INFORMATION

Order Number		Package	Packing
Normal	Lead Free Plating		
1N5819-CA2-R	1N5819L-CA2-R	SOD-123	Tape Reel

www.DataSheet4U.com

<p>1N5819L-CA2-R</p> <p>(1)Packing Type (2)Package Type (3)Lead Plating</p>	<p>(1) R: Tape Reel (2) CA2: SOD-123 (3) L: Lead Free Plating Blank: Pb/Sn</p>
---	--

MARKING

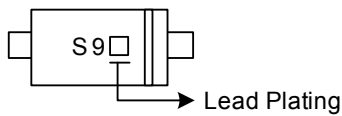

■ ABSOLUTE MAXIMUM RATINGS (Single Diode @ $T_A=25$)

PARAMETER	SYMBOL	RATINGS	UNIT
Maximum Repetitive Peak Reverse Voltage	V_{RRM}	40	V
Maximum non-repetitive Peak Reverse Voltage	V_{RM}	40	V
Maximum DC Blocking Voltage	V_R	40	V
Working Peak Reverse Voltage	V_{RWM}	40	V
Maximum RMS Reverse Voltage	$V_{R(RMS)}$	28	V
Repetitive Peak Forward Current	I_{FRM}	625	mA
Non-repetitive Peak Forward Surge Current 8.3ms Single Half-Sine-Wave	I_{FSM}	25	A
Average Forward Rectified Output Current	I_{OUT}	1	A
Power Dissipation	P_D	250	mW
Storage Temperature Range	T_{STG}	-65~+150	

Note: Absolute maximum ratings are those values beyond which the device could be permanently damaged.

Absolute maximum ratings are stress ratings only and functional device operation is not implied.

■ THERMAL DATA

PARAMETER	SYMBOL	RATINGS	UNIT
Thermal Ambient Resistance Junction to Ambient	θ_{JA}	500	/W

■ ELECTRICAL CHARACTERISTICS ($T_A=25$, unless otherwise specified)

PARAMETER	SYMBOL	TEST CONDITIONS	MIN	TYP	MAX	UNIT
Forward Voltage	V_F	$I_F=1A$			0.6	V
		$I_F=3A$			0.9	V
Reverse Breakdown Voltage	BV_R	$I_R=1mA$	40			V
Reverse Leakage Current	I_R	$V_R=40V$			1	mA
Diode Capacitance	C_D	$V_R=4V, f=1MHz$			120	pF

TYPICAL CHARACTERISTICS

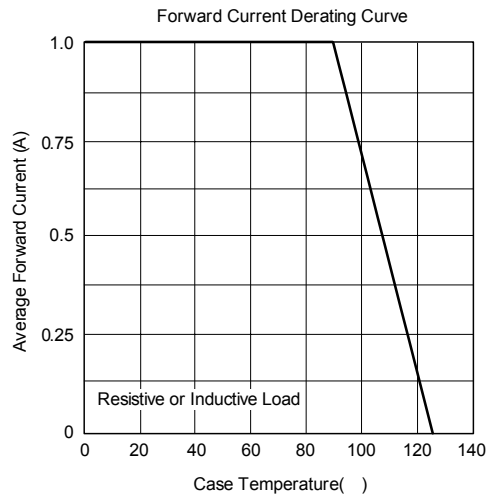
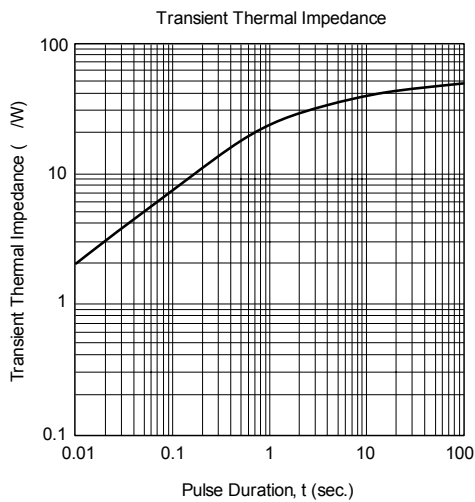
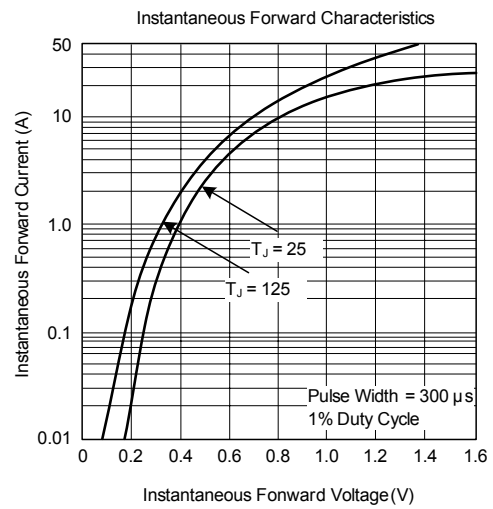
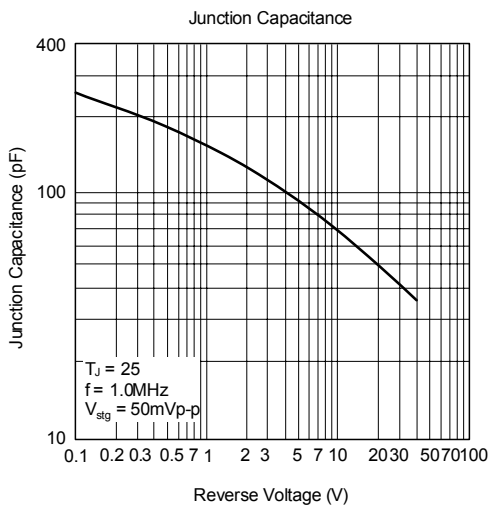
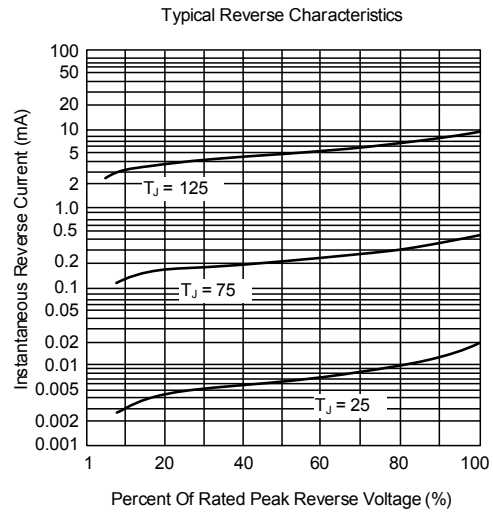
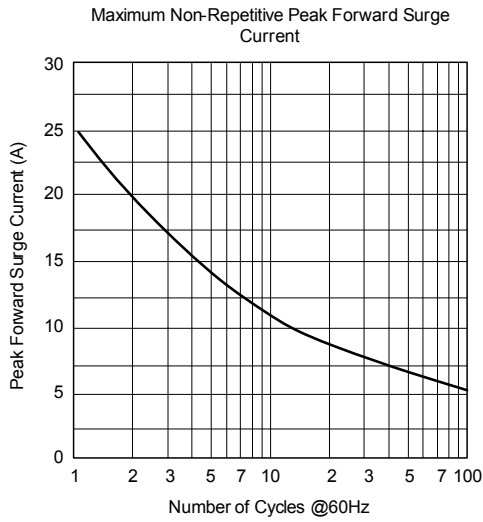

UTC assumes no responsibility for equipment failures that result from using products at values that exceed, even momentarily, rated values (such as maximum ratings, operating condition ranges, or other parameters) listed in products specifications of any and all UTC products described or contained herein. UTC products are not designed for use in life support appliances, devices or systems where malfunction of these products can be reasonably expected to result in personal injury. Reproduction in whole or in part is prohibited without the prior written consent of the copyright owner. The information presented in this document does not form part of any quotation or contract, is believed to be accurate and reliable and may be changed without notice.