



## 1500 Watt Low Clamping Factor Transient Voltage Suppressor

Screening in  
reference to  
MIL-PRF-19500  
available

### DESCRIPTION

This Transient Voltage Suppressor (TVS) series for 1N6358 through 1N6372 are JEDEC registered selections for both unidirectional and bidirectional devices. The 1N6358 through 1N6364 are unidirectional and the 1N6366 through 1N6372 are bidirectional where they all provide a very low specified clamping factor for minimal clamping voltages ( $V_C$ ) above their respective breakdown voltages ( $V_{BR}$ ) as specified herein. They are most often used in protecting sensitive components from inductive switching transients or induced secondary lightning effects as found in lower surge levels of IEC61000-4-5. They are also very successful in protecting airborne avionics and electrical systems. Since their response time is virtually instantaneous, they can also protect from ESD and EFT per IEC61000-4-2 and IEC61000-4-4.

**Important:** For the latest information, visit our website <http://www.microsemi.com>.

### FEATURES

- Unidirectional and bidirectional TVS series in axial package for thru-hole mounting.
- Suppresses transients up to 1500 watts @ 10/1000  $\mu$ s (see [figure 1](#)).
- $t_{clamping}$  (0 volts to  $V_{(BR)}$  min):  
Unidirectional – Less than 100 picoseconds.  
Bidirectional – Less than 5 nanoseconds.
- Working voltage ( $V_{WM}$ ) range 10 V to 45 V.
- Low clamping factor (ratio of actual  $V_C/V_{BR}$ ): 1.33 @ full rated power and 1.20 @ 50% rated power.
- Hermetically sealed DO-13 metal package.
- Upscreening in reference to MIL-PRF-19500 is available.
- RoHS compliant versions available.

### APPLICATIONS / BENEFITS

- Designed to protect bipolar and MOS microprocessor based systems
- Protection from switching transients and induced RF.
- Protection from ESD & EFT per IEC 61000-4-2 and IEC 61000-4-4.
- Secondary lightning protection per IEC61000-4-5 with 42 ohms source impedance:  
Class 1, 2 & 3: 1N6358 to 1N6372  
Class 4: 1N6358 to 1N6362 and 1N6366 to 1N6370
- Secondary lightning protection per IEC61000-4-5 with 12 ohms source impedance:  
Class 1 & 2: 1N6358 to 1N6372  
Class 3: 1N6358 to 1N6362 and 1N6366 to 1N6370  
Class 4: 1N6358 and 1N6366
- Secondary lightning protection per IEC61000-4-5 with 2 ohms source impedance:  
Class 2: 1N6358 to 1N6361 and 1N6366 to 1N6369  
Class 3: 1N6358 and 1N6366
- Inherently radiation hard as described in Microsemi "[MicroNote 050](#)".

### MAXIMUM RATINGS

Parameters/Test Conditions	Symbol	Value	Unit
Junction and Storage Temperature	$T_J$ and $T_{STG}$	-65 to +175	$^{\circ}$ C
Thermal Resistance, Junction to Lead @ 0.375 inch (10 mm) from body	$R_{\theta JL}$	50	$^{\circ}$ C/W
Thermal Resistance, Junction to Ambient <sup>(1)</sup>	$R_{\theta JA}$	110	$^{\circ}$ C/W
Peak Pulse Power @ $T_L = +25$ $^{\circ}$ C <sup>(2)</sup>	$P_{PP}$	1500	W
Rated Average Power Dissipation @ $T_L \leq +125$ $^{\circ}$ C <sup>(3)</sup>	$P_{M(AV)}$	1	W
Solder Temperature @ 10 s	$T_{SP}$	260	$^{\circ}$ C

- Notes:**
1. When mounted on FR4 PC board with 4 mm<sup>2</sup> copper pads (1 oz) and track width 1 mm, length 25 mm.
  2. At 10/1000  $\mu$ s with repetition rate of 0.01% or less (see [figures 1, 2, & 4](#)).
  3. At 3/8 inch (10 mm) from body (see derating in [figure 5](#)). TVS devices are not typically used for dc power dissipation and are instead operated at or less than their rated standoff voltage ( $V_{WM}$ ) except for transients that briefly drive the device into avalanche breakdown ( $V_{BR}$  to  $V_C$  region).

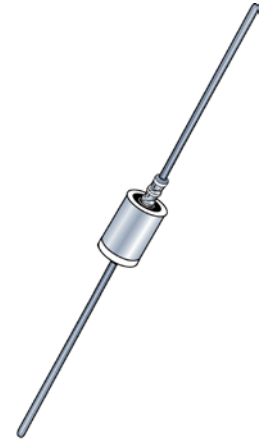

DO-13 (DO-202AA)  
Package

#### MSC – Lawrence

6 Lake Street,  
Lawrence, MA 01841  
Tel: 1-800-446-1158 or  
(978) 620-2600  
Fax: (978) 689-0803

#### MSC – Ireland

Gort Road Business Park,  
Ennis, Co. Clare, Ireland  
Tel: +353 (0) 65 6840044  
Fax: +353 (0) 65 6822298

#### Website:

[www.microsemi.com](http://www.microsemi.com)

**MECHANICAL and PACKAGING**

- CASE: DO-13 (DO-202AA), welded, hermetically sealed metal and glass.
- TERMINALS: All external metal surfaces are tin-lead plated or RoHS compliant annealed matte-tin plating solderable per MIL-STD-750 method 2026.
- MARKING: Part number and polarity diode symbol.
- POLARITY: Cathode connected to case and polarity indicated by diode symbol.
- TAPE & REEL option: Standard per EIA-296 (add "TR" suffix to part number). Consult factory for quantities.
- WEIGHT: Approximately 1.4 grams.
- See [package dimensions](#) on last page.

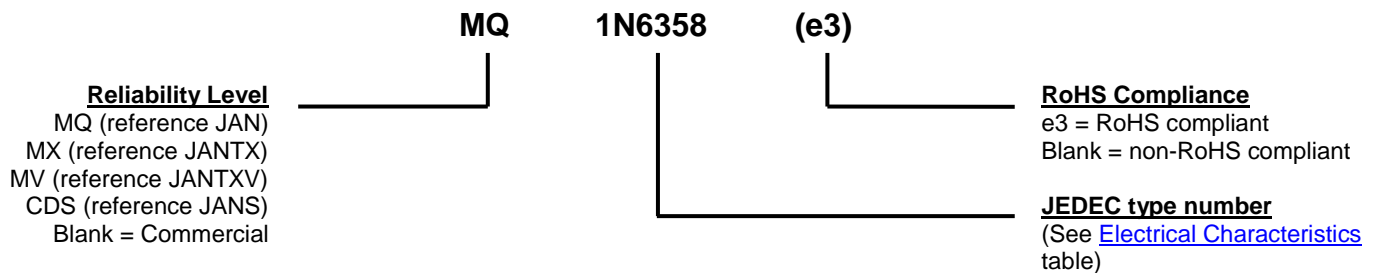
**PART NOMENCLATURE**

**SYMBOLS & DEFINITIONS**

Symbol	Definition
$V_{WM}$	Standoff Voltage: Applied Reverse Voltage to assure a nonconductive condition.
$V_{(BR)}$	Breakdown Voltage: This is the Breakdown Voltage the device will exhibit at 25 °C.
$V_C$	Maximum Clamping Voltage: The maximum peak voltage appearing across the TVS when subjected to the peak pulse current in a one millisecond time interval. The peak pulse voltage is the combination of voltage rise due to both the series resistance and thermal rise and positive temperature coefficient ( $\alpha_{V(BR)}$ ).
$I_{PP}$	Peak Pulse Current: The peak current during the impulse. (See <a href="#">figure 2</a> )
$P_{PP}$	Peak Pulse Power: The pulse power as determined by the product of $V_C$ and $I_{PP}$ .
$I_D$	Standby Current: The current at the standoff voltage ( $V_{WM}$ ).

**ELECTRICAL CHARACTERISTICS @ 25 °C (Both Polarities)**
**Unidirectional**

MICROSEMI PART NUMBER		STANDOFF VOLTAGE (NOTE 1) $V_{WM}$  Volts	MAXIMUM REVERSE LEAKAGE @ $V_{WM}$ $I_D$  $\mu A$	MINIMUM* BREAKDOWN VOLTAGE @ 1.0 mA $V_{(BR)}$ (min)  Volts	MAXIMUM CLAMPING VOLTAGE (Fig. 2) $I_{PP1} = 1A$ $V_C$  Volts	MAXIMUM CLAMPING VOLTAGE (Fig. 2) @ $I_{PP2} = 10A$ $V_C$  Volts	MAXIMUM PEAK PULSE CURRENT $I_{PP3}$  A
1N6358	MPT-10	10.0	2	11.7	13.7	14.1	90
1N6359	MPT-12	12.0	2	14.1	16.1	16.5	70
1N6360	MPT-15	15.0	2	17.6	20.1	20.6	60
1N6361	MPT-18	18.0	2	21.2	24.2	25.2	50
1N6362	MPT-22	22.0	2	25.9	29.8	32.0	40
1N6363	MPT-36	36.0	2	42.4	50.6	54.3	23
1N6364	MPT-45	45.0	2	52.9	63.3	70.0	19

$V_F$  at 100 amps peak is 3.5 volts maximum at 8.3 ms half-sine wave.

**Bidirectional**

MICROSEMI PART NUMBER		STANDOFF VOLTAGE (NOTE 1) $V_{WM}$  Volts	MAXIMUM REVERSE LEAKAGE @ $V_{WM}$ $I_D$  $\mu A$	MINIMUM* BREAKDOWN VOLTAGE @ 1.0 mA $V_{(BR)}$ (min)  Volts	MAXIMUM CLAMPING VOLTAGE (Fig. 2) $I_{PP1} = 1A$ $V_C$  Volts	MAXIMUM CLAMPING VOLTAGE (Fig. 2) @ $I_{PP2} = 10A$ $V_C$  Volts	MAXIMUM PEAK PULSE CURRENT $I_{PP3}$  A
1N6366	MPT-10C	10.0	2	11.7	14.1	14.5	90
1N6367	MPT-12C	12.0	2	14.1	16.7	17.1	70
1N6368	MPT-15C	15.0	2	17.6	20.8	21.4	60
1N6369	MPT-18C	18.0	2	21.2	24.8	25.5	50
1N6370	MPT-22C	22.0	2	25.9	30.8	32.0	40
1N6371	MPT-36C	36.0	2	42.4	50.6	54.3	23
1N6372	MPT-45C	45.0	2	52.9	63.3	70.0	19

"C" suffix indicates bidirectional

**NOTE 1:** TVS devices are normally selected according to the reverse "standoff voltage" ( $V_{WM}$ ) which should be equal to or greater than the DC or continuous peak operating voltage level.

\* The minimum breakdown voltage as shown takes into consideration the  $\pm$  volt tolerance normally specified for power supply regulation on most integrated circuit manufacturers data sheets. Similar devices are available with reduced clamping voltages where tighter regulated power supply voltages are employed.

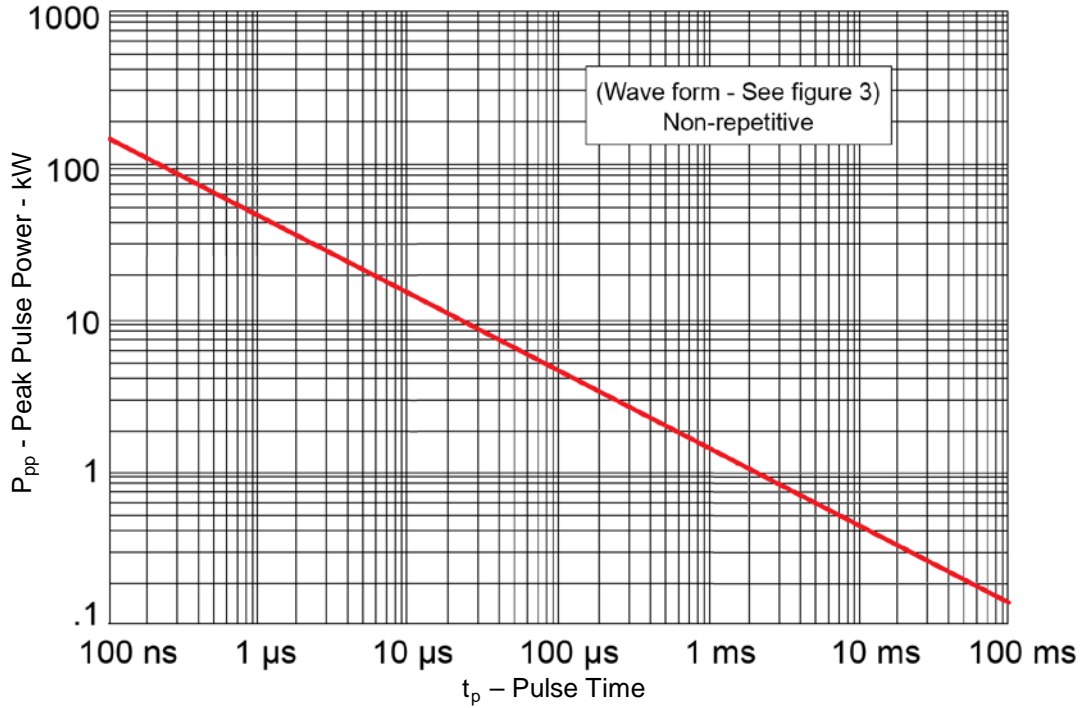
**GRAPHS**

**FIGURE 1**  
Peak Pulse Power vs Pulse Time

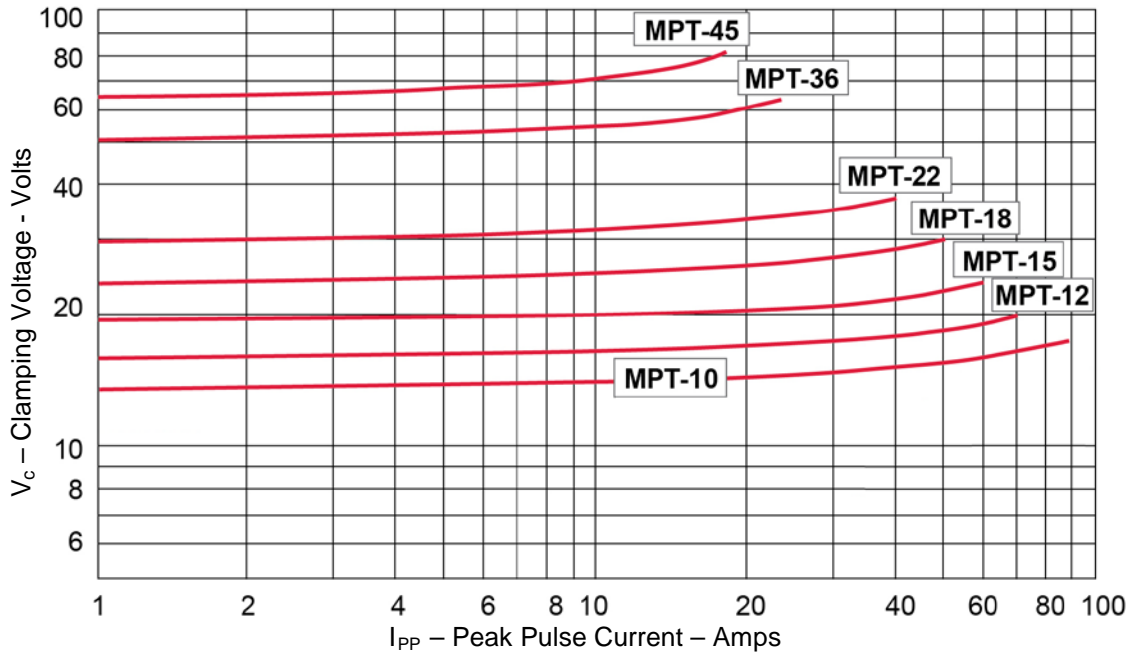

**FIGURE 2**  
Typical Characteristic Clamping Voltage vs. Peak Pulse Current

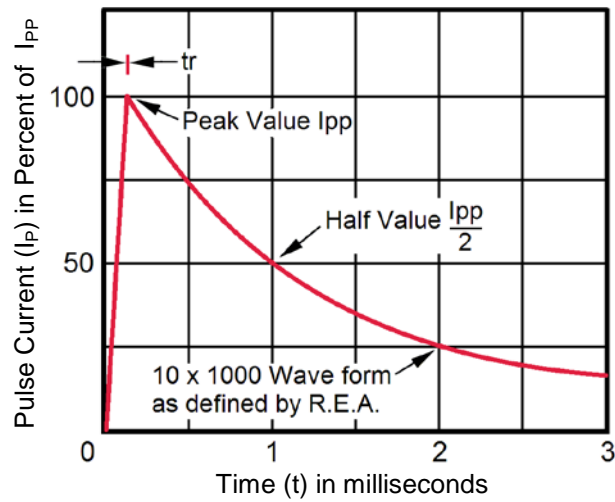
**GRAPHS**

**FIGURE 3**  
Pulse Wave Form for Exponential Surge

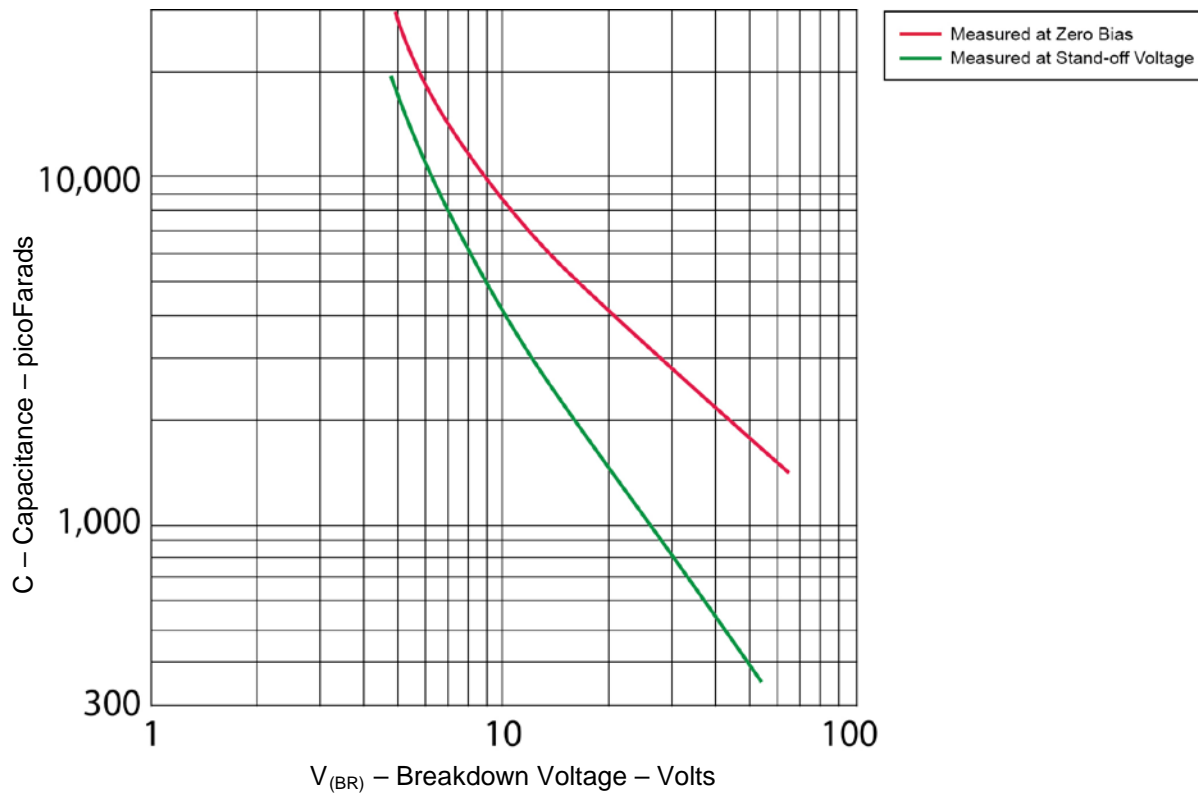

**FIGURE 4**  
Typical Capacitance vs. Breakdown Voltage (Unidirectional Types)

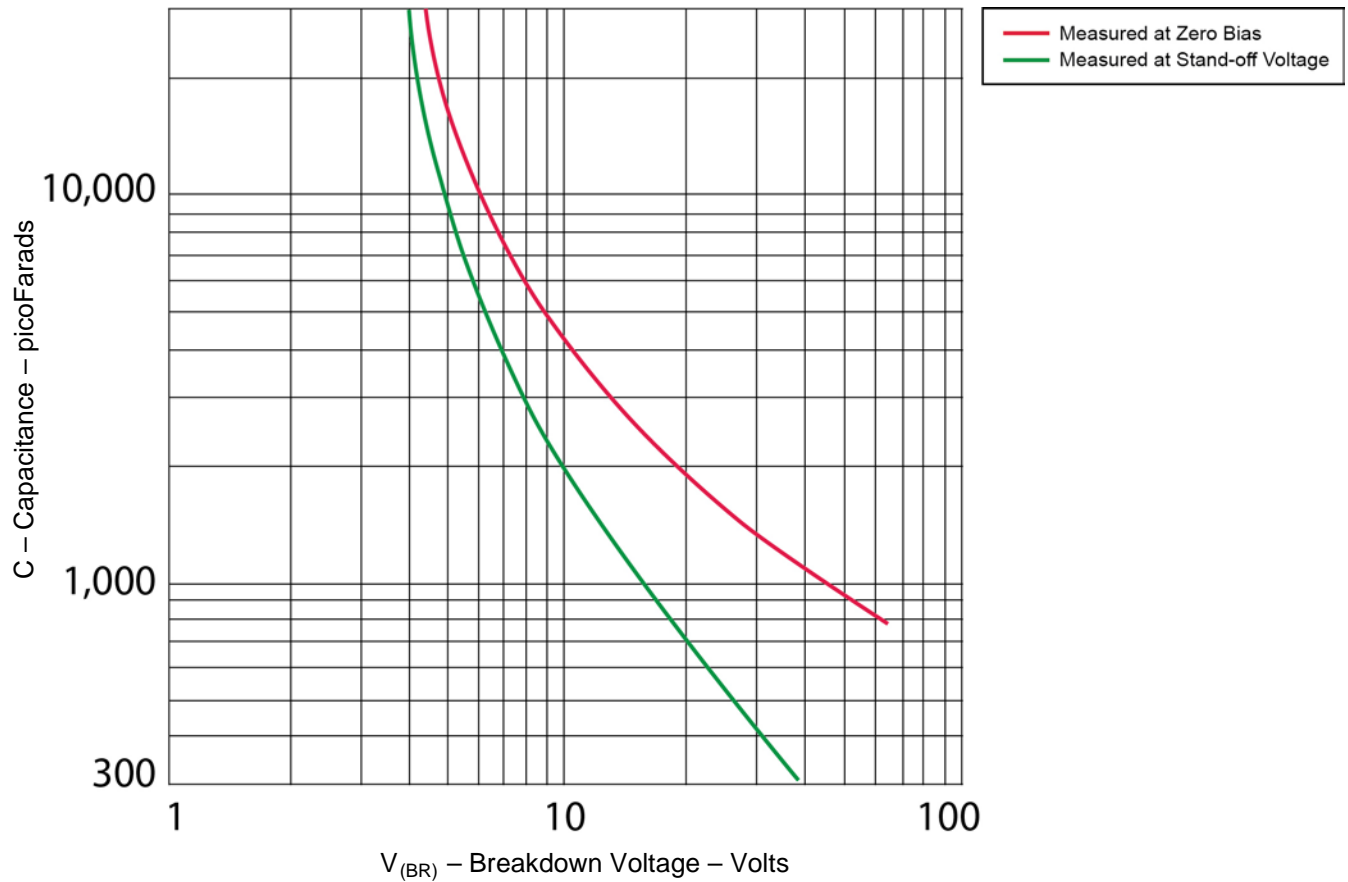
**GRAPHS**

**FIGURE 5**  
Typical Capacitance vs. Breakdown Voltage (Bidirectional Types)

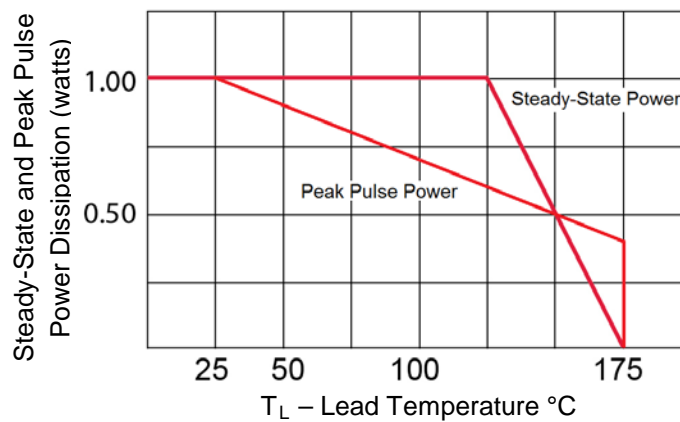

**FIGURE 6**  
Steady-State and Peak Pulse Power Derating Curve

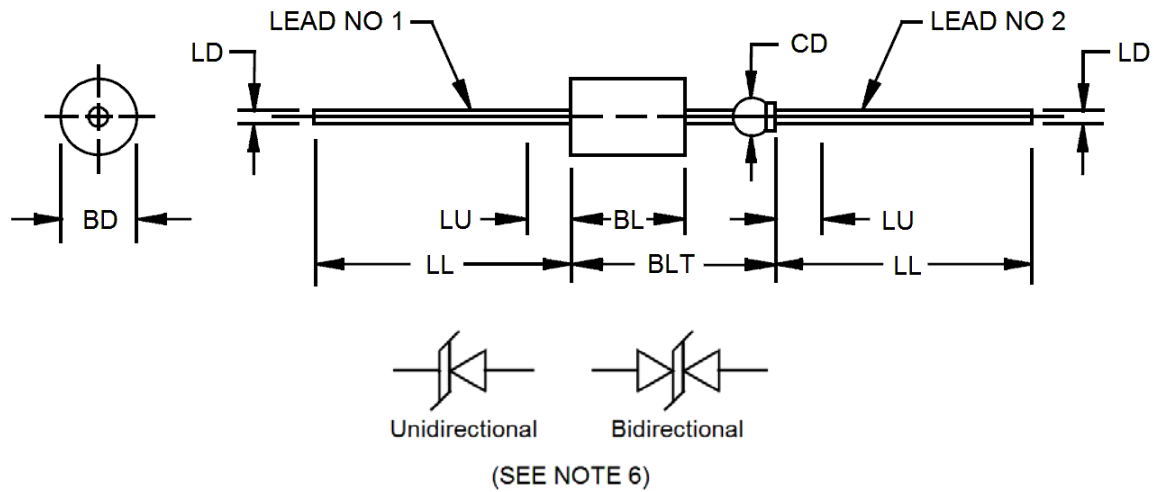
**PACKAGE DIMENSIONS**

**NOTES:**

1. Dimensions are in inches.
2. Millimeter equivalents are given for general information only.
3. The major diameter is essentially constant along its length.
4. Within this zone, diameter may vary to allow for lead finishes and irregularities.
5. Dimension to allow for pinch or seal deformation anywhere along tubulation.
6. Polarity symbol for transient suppressor.
7. Lead 1 shall be electrically connected to the case.
8. In accordance with ASME Y14.5M, diameters are equivalent to  $\Phi x$  symbology.

Symbol	Dimensions				Notes
	Inches		Millimeters		
	Min	Max	Min	Max	
<b>BD</b>	0.215	0.235	5.46	5.97	
<b>BL</b>	0.293	0.357	7.44	9.07	3
<b>BLT</b>	-	0.570	-	14.48	
<b>CD</b>	0.045	0.100	1.14	2.54	5
<b>LD</b>	0.025	0.035	0.64	0.89	
<b>LL</b>	1.000	1.625	25.40	41.28	
<b>LU</b>	-	0.188	-	4.78	4