

Small Signal Product

Features

- ◇ Fast switching device($T_{rr}<4.0ns$)
- ◇ Surface device type mounting
- ◇ Moisture sensitivity level 1
- ◇ Matte Tin(Sn) lead finish with Nickel(Ni) underplate
- ◇ Pb free version and RoHS compliant
- ◇ Green compound (Halogen free) with suffix "G" on packing code and prefix "G" on date code

SOD-323F



Mechanical Data

- ◇ Case : Flat lead SOD-323F small outline plastic package
- ◇ Terminal : Matte tin plated, solderable per MIL-STD-202, method 208 guaranteed
- ◇ High temperature soldering guaranteed : 260°C/10s
- ◇ Polarity : Indicated by cathode band
- ◇ Weight : 4.85 ± 0.5 mg
- ◇ Marking Code : S1, S2, S3



Ordering Information (example)

Part No.	Package	Packing	Packing code	Packing code (Green)	Manufacture code
1N4148WS	SOD-323F	3K / 7" Reel	RR	RRG	

Note : Detail please see "Ordering Information(detail, example)" below.

Maximum Ratings and Electrical Characteristics

Rating at 25°C ambient temperature unless otherwise specified.

Maximum Ratings

Parameter	Symbol	Value	Units
Power Dissipation	P_D	200	mW
Non-Repetitive Peak Reverse Voltage	V_{RM}	100	V
Repetitive Peak Reverse Voltage	V_{RRM}	75	V
Reverse Voltage	V_R	100	V
Non-Repetitive Peak Forward Current	I_{FRM}	300	mA
Mean Forward Current	I_O	150	mA
Thermal Resistance (Junction to Ambient)	$R_{\theta JA}$	625	°C/W
Junction and Storage Temperature Range	T_J, T_{STG}	-65 to + 150	°C

Electrical Characteristics

Parameter	Symbol	Min	Max	Units	
Reverse Breakdown Voltage	$V_{(BR)}$	$I_R=100\mu A$	100	-	V
		$I_R=5\mu A$	75	-	
Forward Voltage	V_F	1N4448WS, 1N914BWS $I_F=5.0mA$	0.62	0.72	V
		1N4148WS $I_F=10.0mA$	-	1.0	
		1N4448WS, 1N914BWS $I_F=100.0mA$	-	1.0	
Reverse Leakage Current	I_R	$V_R=20V$	-	25	nA
		$V_R=75V$	-	5.0	μA
Junction Capacitance	C_J	-	4.0	pF	
Reverse Recovery Time	T_{rr}	-	4.0	ns	

Small Signal Product

RATINGS AND CHARACTERISTIC CURVES

Fig. 1 Forward Voltage VS. Forward Current

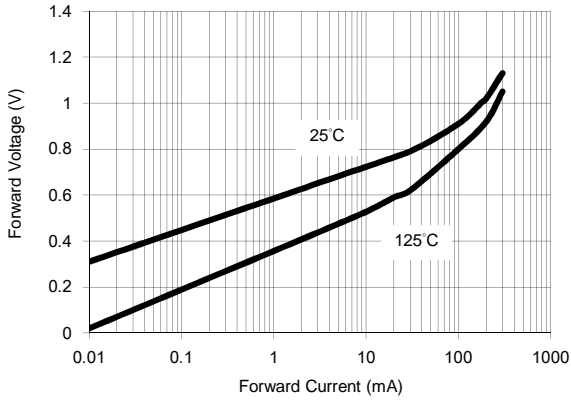

Fig. 2 Reverse Current vs Reverse Voltage

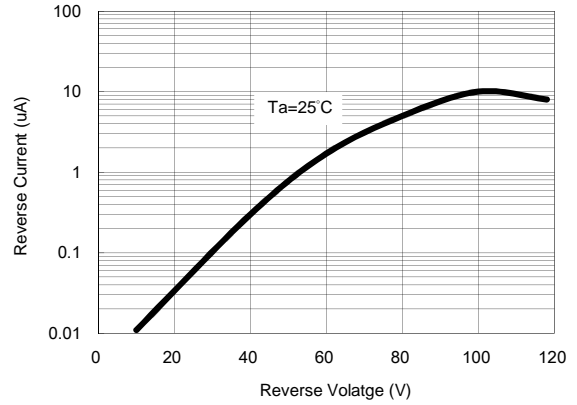

Fig. 3 Admissible Power Dissipation Curve

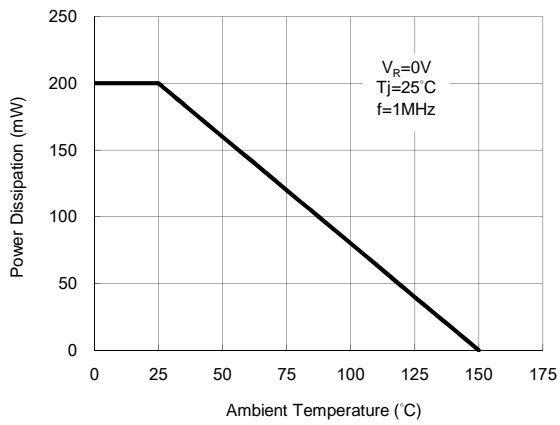
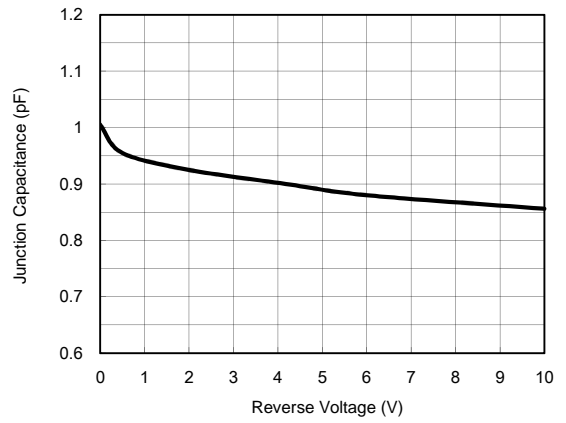

Fig. 4 Typical Junction Capacitance



Small Signal Product

Ordering information (Detail, example)

Part No.	Package	Packing	Packing code	Packing code (Green)	Manufacture code
1NxxxxWS (Note 1)	SOD-323	3K / 7" Reel	RR	RRG	(Note 2)
		3K / 7" Reel	RQ	RQG	
1N4148WS	SOD-323	3K / 7" Reel	RR	RRG	
1N4148WS	SOD-323	3K / 7" Reel	RR	RRG	

Note 1 : "xxxx" is Device Code from "4148" to "914B".

Note 2 : Manufacture special control, if empty means no special control requirement.

Tape & Reel specification

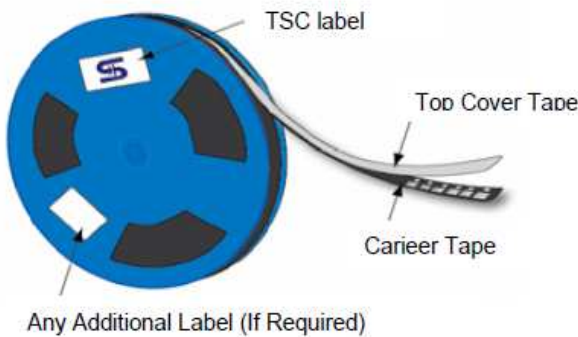

Item	Symbol	Dimension(mm)
Carrier depth	K	2.40 Max.
Sprocket hole	D	1.5 ± 0.1
Reel outside diameter	A	178 ± 1
Reel inner diameter	D1	50 Min.
Feed hole width	D2	13.0 ± 0.5
Sprocket hole position	E	1.75 ± 0.10
Punch hole position	F	3.50 ± 0.05
Sprocket hole pitch	P0	4.00 ± 0.10
Embossment center	P1	2.00 ± 0.10
Overall tape thickness	T	0.6 Max.
Tape width	W	8.30 Max.
Reel width	W1	14.4 Max

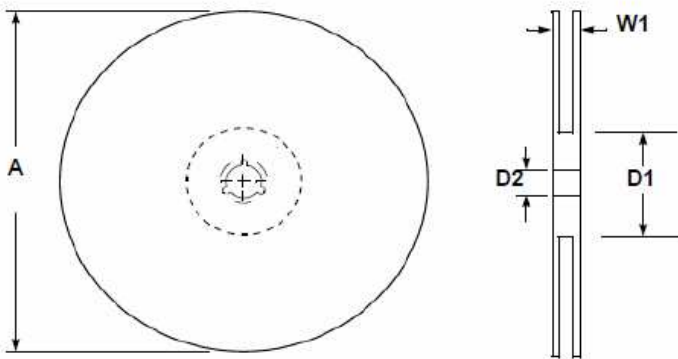
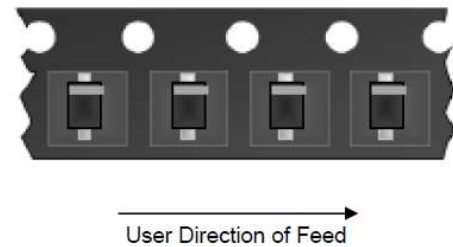
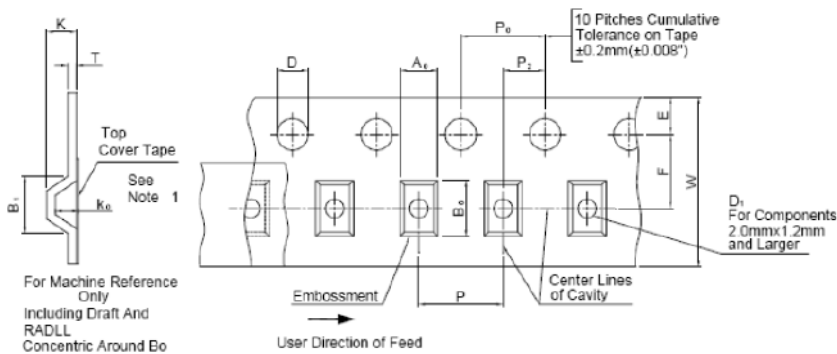

Note 1 : A_0 , B_0 , and K_0 are determined by component size. The clearance between the components and the cavity must be within 0.05 mm min. to 0.5 mm max. The component cannot rotate more than 10° within the determined cavity.

Note 2 : If B_1 exceeds 4.2mm(0.165") for 8 mm embossed tape, the tape may not feed through all tape feeders.

Dimensions

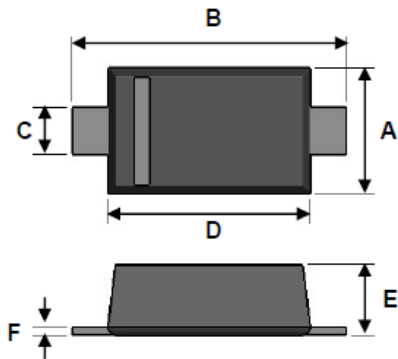

DIM.	Unit (mm)		Unit (inch)	
	Min	Max	Min	Max
A	1.15	1.35	0.045	0.053
B	2.30	2.80	0.091	0.110
C	0.25	0.40	0.010	0.016
D	1.60	1.80	0.063	0.071
E	0.80	1.10	0.031	0.043
F	0.05	0.25	0.002	0.010

Suggested PAD Layout

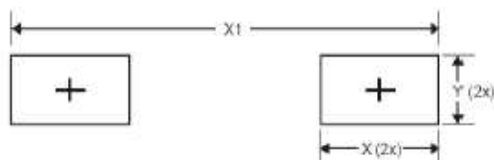

DIM.	Unit(mm)	Unit(inch)
	Typ.	Typ.
X	0.710	0.028
X1	2.900	0.114
Y	0.403	0.016

Marking

Part No.	Marking
1N4148WS	S1
1N4448WS	S2
1N914BWS	S3

Note : 1. The suggested land pattern dimensions have been provided for reference only, as actual pad layouts may vary depending on application.