

Single P-Channel, -20V, -2.4A, Power MOSFET

V _{DS} (V)	R _{ds(on)} (Ω)
-20	0.081@ V _{GS} =-4.5V
	0.103@ V _{GS} =-2.5V

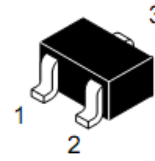

Descriptions

The 2015 is P-Channel enhancement MOS Field Effect Transistor. Uses advanced trench technology and design to provide excellent R_{DS(ON)} with low gate charge. This device is suitable for use in DC-DC conversion, power switch and charging circuit. Standard Product 2015 is Pb-free and Halogen-free.

SOT-23

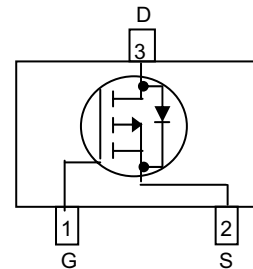

Pin configuration (Top view)

Features

- Trench Technology
- Supper high density cell design
- Excellent ON resistance for higher DC current
- Extremely Low Threshold Voltage
- Small package SOT-23

Applications

- Driver for Relay, Solenoid, Motor, LED etc.
- DC-DC converter circuit
- Power Switch
- Load Switch
- Charging

**Absolute Maximum ratings**

Parameter		Symbol	10 S	Steady State	Unit
Drain-Source Voltage		V_{DS}	-20		V
Gate-Source Voltage		V_{GS}	± 8		
Continuous Drain Current ^a	$T_A=25^\circ\text{C}$	I_D	-2.4	-2.2	A
	$T_A=70^\circ\text{C}$		-1.9	-1.7	
Maximum Power Dissipation ^a	$T_A=25^\circ\text{C}$	P_D	0.9	0.8	W
	$T_A=70^\circ\text{C}$		0.5	0.5	
Continuous Drain Current ^b	$T_A=25^\circ\text{C}$	I_D	-2.2	-2.0	A
	$T_A=70^\circ\text{C}$		-1.7	-1.6	
Maximum Power Dissipation ^b	$T_A=25^\circ\text{C}$	P_D	0.7	0.6	W
	$T_A=70^\circ\text{C}$		0.5	0.4	
Pulsed Drain Current ^c		I_{DM}	-10		A
Operating Junction Temperature		T_J	150		$^\circ\text{C}$
Lead Temperature		T_L	260		$^\circ\text{C}$
Storage Temperature Range		T_{stg}	-55 to 150		$^\circ\text{C}$

Thermal resistance ratings

Parameter		Symbol	Typical	Maximum	Unit
Junction-to-Ambient Thermal Resistance ^a	$t \leq 10 \text{ s}$	$R_{\theta JA}$	105	135	$^\circ\text{C/W}$
	Steady State		120	155	
Junction-to-Ambient Thermal Resistance ^b	$t \leq 10 \text{ s}$	$R_{\theta JA}$	130	160	
	Steady State		145	190	
Junction-to-Case Thermal Resistance		$R_{\theta JC}$	60	75	

a Surface mounted on FR-4 Board using 1 square inch pad size, 1oz copper

b Surface mounted on FR-4 board using minimum pad size, 1oz copper

c Pulse width $<380\mu\text{s}$, Duty Cycle $<2\%$

d Maximum junction temperature $T_J=150^\circ\text{C}$.



Electronics Characteristics (Ta=25°C, unless otherwise noted)

Parameter	Symbol	Test Conditions	Min	Typ	Max	Unit
OFF CHARACTERISTICS						
Drain-to-Source Breakdown Voltage	BV _{DSS}	V _{GS} = 0 V, I _D = -250uA	-20			V
Zero Gate Voltage Drain Current	I _{DSS}	V _{DS} = -16V, V _{GS} = 0V			-1	uA
Gate-to-source Leakage Current	I _{GSS}	V _{DS} = 0 V, V _{GS} = ±8V			±100	nA
ON CHARACTERISTICS						
Gate Threshold Voltage	V _{GS(TH)}	V _{GS} = V _{DS} , I _D = -250uA	-0.40	-0.62	-0.81	V
Drain-to-source On-resistance ^{b, c}	R _{DS(on)}	V _{GS} = -4.5V, I _D = -2.7A		81	110	mΩ
		V _{GS} = -2.5V, I _D = -2.2A		103	150	
CAPACITANCES, CHARGES						
Input Capacitance	C _{ISS}	V _{GS} = 0 V, f = 1.0 MHz, V _{DS} = -10 V		534		pF
Output Capacitance	C _{OSS}			62		
Reverse Transfer Capacitance	C _{RSS}			54		
Total Gate Charge	Q _{G(TOT)}	V _{GS} = -4.5 V, V _{DS} = -10 V, I _D = -2.7A		7.3		nC
Threshold Gate Charge	Q _{G(TH)}			0.5		
Gate-to-Source Charge	Q _{GS}			1.25		
Gate-to-Drain Charge	Q _{GD}			1.15		
SWITCHING CHARACTERISTICS						
Turn-On Delay Time	td(ON)	V _{GS} = -4.5 V, V _{DS} = -10 V, I _D = -1.2A, R _G = 6 Ω		8.0		ns
Rise Time	tr			6.4		
Turn-Off Delay Time	td(OFF)			41.0		
Fall Time	tf			7.0		
BODY DIODE CHARACTERISTICS						
Forward Voltage	V _{SD}	V _{GS} = 0 V, I _S = -0.9A		-0.74	-1.5	V

Typical Characteristics (Ta=25°C, unless otherwise noted)

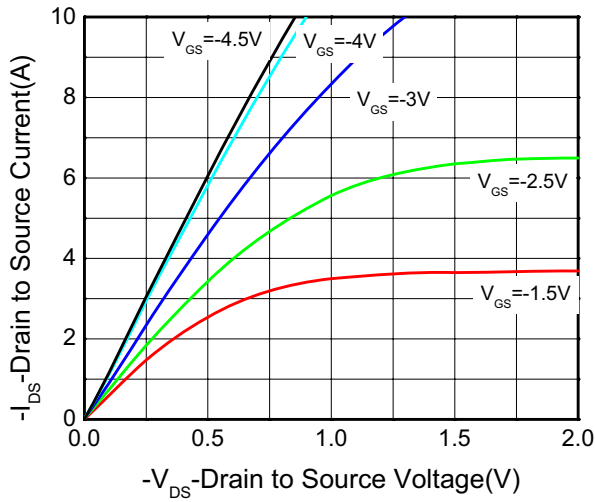

Output characteristics

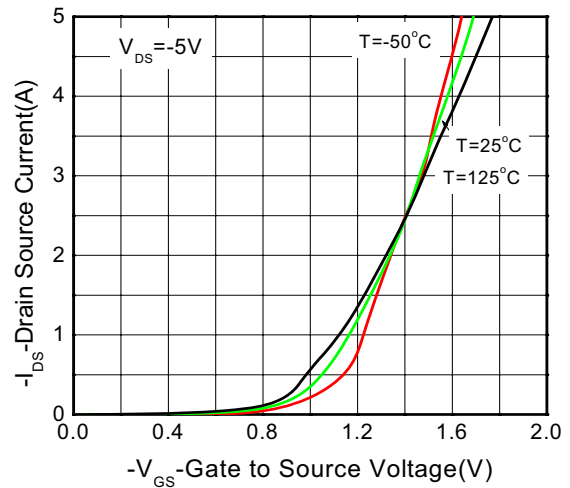

Transfer characteristics

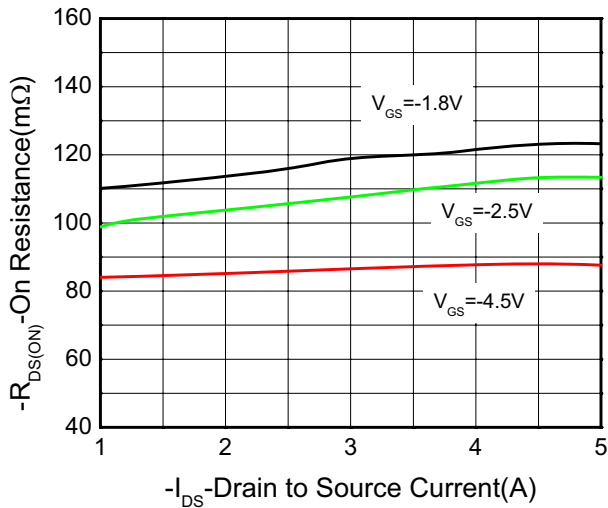

On-Resistance vs. Drain current

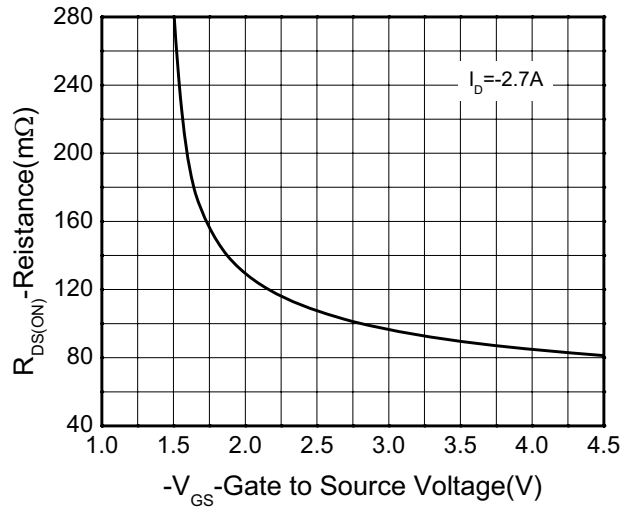

On-Resistance vs. Gate-to-Source voltage

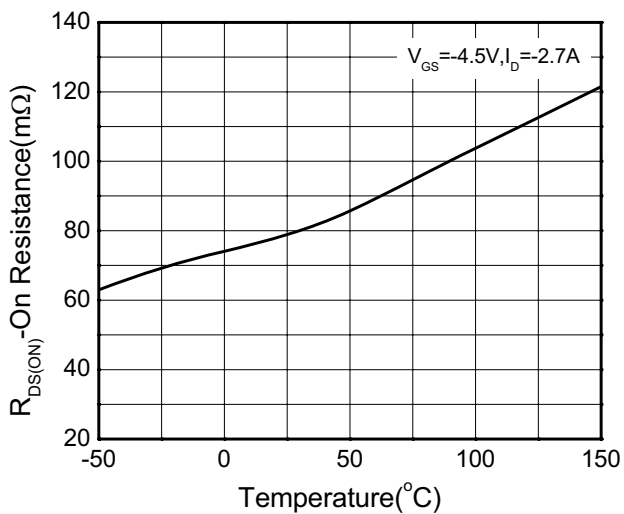

On-Resistance vs. Junction temperature

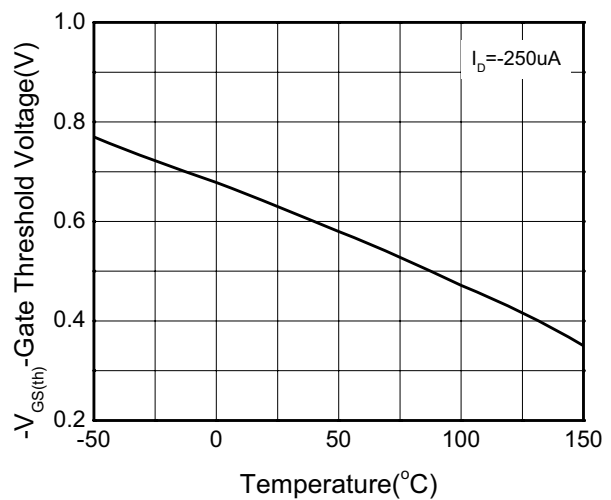

Threshold voltage vs. Temperature

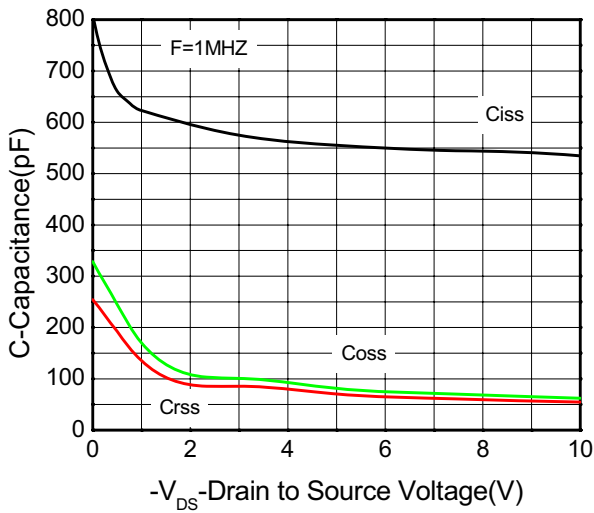

Capacitance

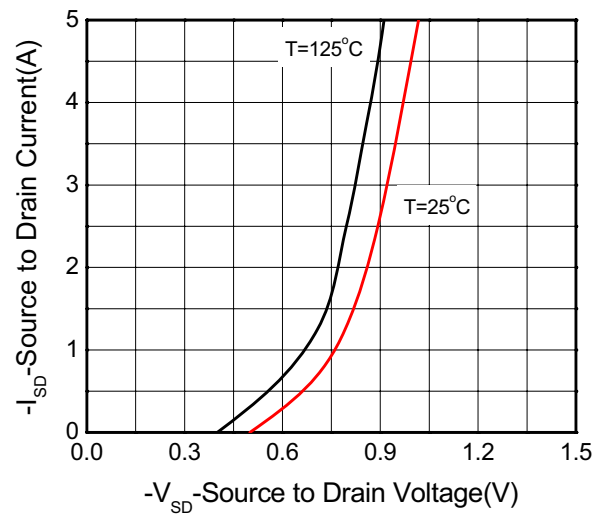

Body diode forward voltage

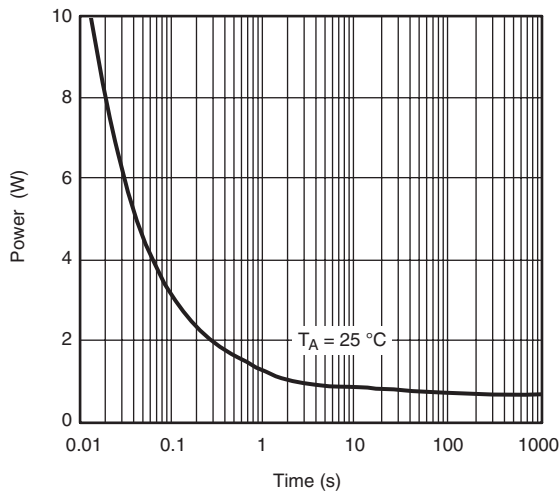

Single pulse power

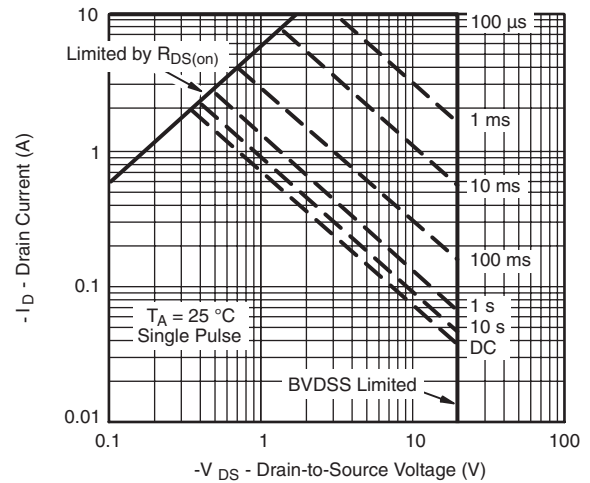

Safe operating power

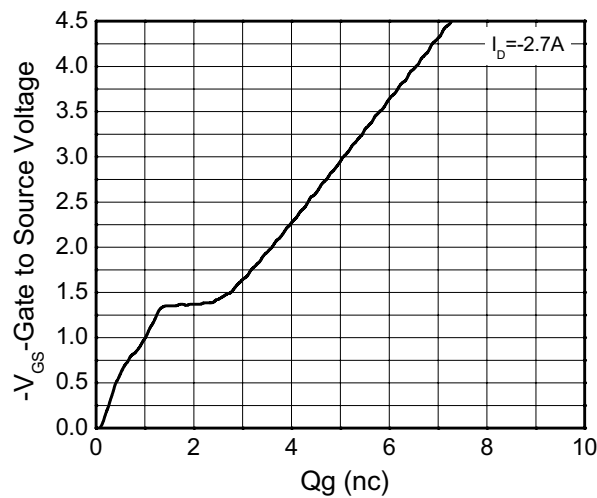

Gate Charge Characteristics

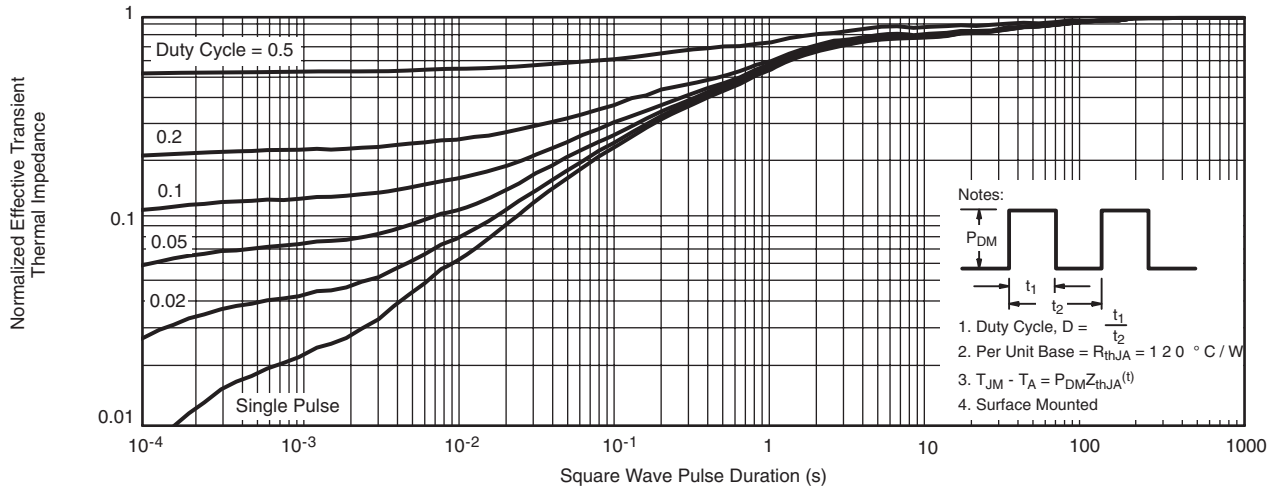

Transient thermal response (Junction-to-Ambient)

Package outline dimensions

SOT-23

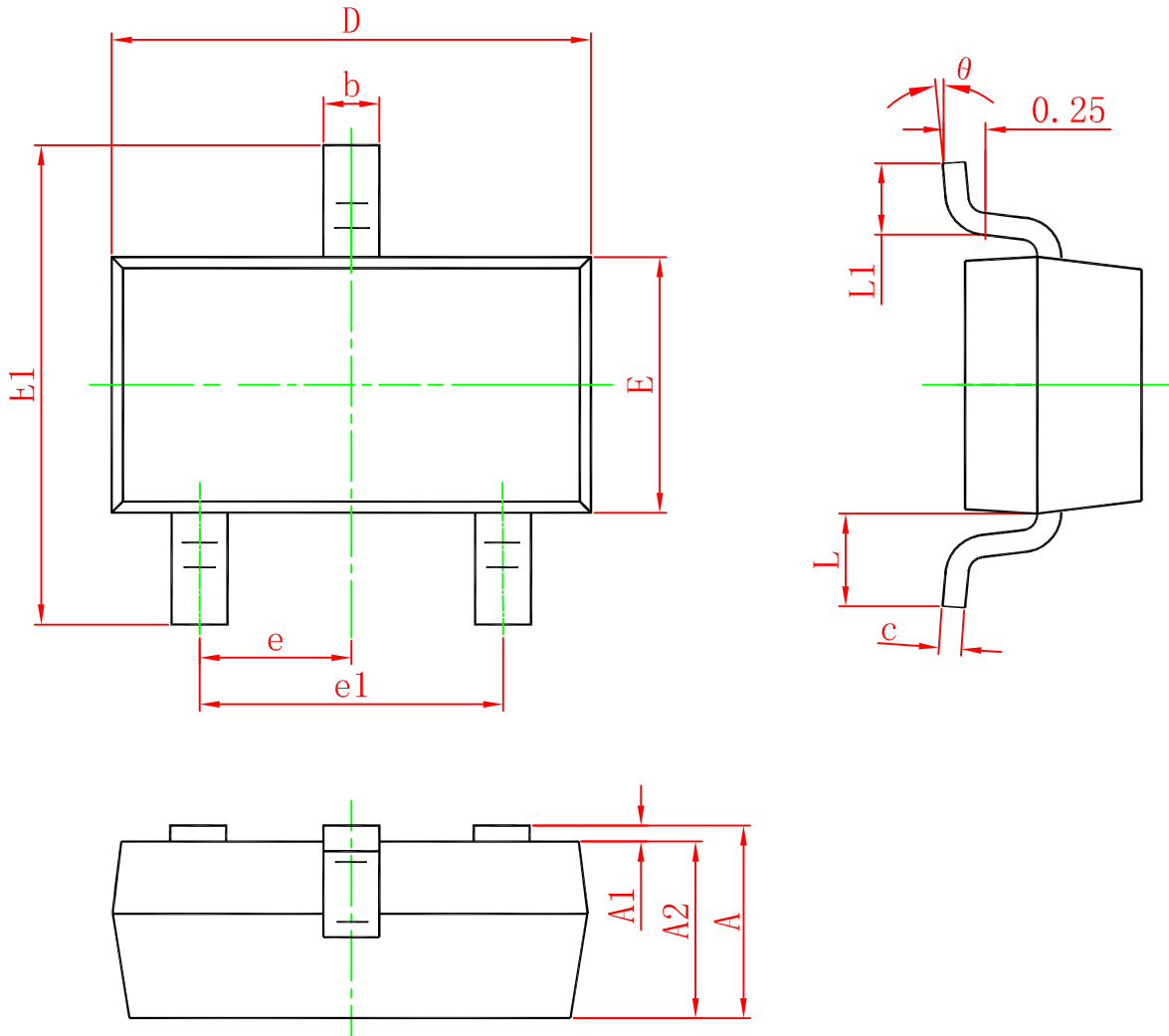

Symbol	Dimensions in millimeter		
	Min.	Typ.	Max.
A	0.900	1.025	1.150
A1	0.000	0.050	0.100
A2	0.900	0.975	1.050
b	0.300	0.400	0.500
c	0.080	0.115	0.150
D	2.800	2.900	3.000
E	1.200	1.300	1.400
E1	2.250	2.400	2.550
e	0.950TYP		
e1	1.800	1.900	2.000
L	0.550REF		
L1	0.300		0.500
θ	0°		8°