

# International IOR Rectifier

## 20CTQ... 20CTQ...S 20CTQ... -1

SCHOTTKY RECTIFIER

20 Amp

$I_{F(AV)} = 20\text{Amp}$   
 $V_R = 35/ 45\text{V}$

### Major Ratings and Characteristics



Characteristics	Values	Units
$I_{F(AV)}$ Rectangular waveform	20	A
$V_{RRM}$ range	35 / 45	V
$I_{FSM}$ @ $t_p = 5 \mu\text{s}$ sine	1060	A
$V_F$ @ $10\text{Apk}$ , $T_J = 125^\circ\text{C}$ (per leg)	0.57	V
$T_J$ range	-55 to 175	$^\circ\text{C}$

### Description/Features

The 20CTQ center tap Schottky rectifier series has been optimized for low reverse leakage at high temperature. The proprietary barrier technology allows for reliable operation up to  $175^\circ\text{C}$  junction temperature. Typical applications are in switching power supplies, converters, free-wheeling diodes, and reverse battery protection.

- $175^\circ\text{C}$   $T_J$  operation
- Center tap TO-220 package
- Low forward voltage drop
- High purity, high temperature epoxy encapsulation for enhanced mechanical strength and moisture resistance
- High frequency operation
- Guard ring for enhanced ruggedness and long term reliability

### Case Styles

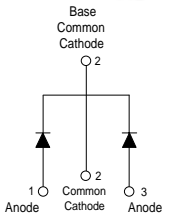
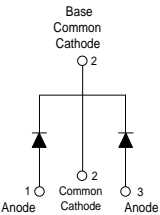
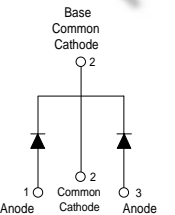
20CTQ...	20CTQ... S	20CTQ... -1
		
<p>Base Common Cathode</p>  <p>1 Anode    2 Common Cathode    3 Anode</p> <p>TO-220</p>	<p>Base Common Cathode</p>  <p>1 Anode    2 Common Cathode    3 Anode</p> <p>D²PAK</p>	<p>Base Common Cathode</p>  <p>1 Anode    2 Common Cathode    3 Anode</p> <p>TO-262</p>

## Voltage Ratings

Part number	20CTQ035	20CTQ040	20CTQ045
$V_R$ Max. DC Reverse Voltage (V)	35	40	45
$V_{RWM}$ Max. Working Peak Reverse Voltage (V)			

## Absolute Maximum Ratings

Parameters	20CTQ	Units	Conditions
$I_{F(AV)}$ Max. Average Forward Current * See Fig. 5	20	A	50% duty cycle @ $T_C = 145^\circ\text{C}$ , rectangular wave form
$I_{FSM}$ Max. Peak One Cycle Non-Repetitive Surge Current (Per Leg) * See Fig. 7	1060	A	5 $\mu\text{s}$ Sine or 3 $\mu\text{s}$ Rect. pulse 10ms Sine or 6ms Rect. pulse
	265		
$E_{AS}$ Non-Repetitive Avalanche Energy (Per Leg)	13	mJ	$T_J = 25^\circ\text{C}$ , $I_{AS} = 2.0$ Amps, $L = 6.5$ mH
$I_{AR}$ Repetitive Avalanche Current (Per Leg)	2.0	A	Current decaying linearly to zero in 1 $\mu\text{sec}$ Frequency limited by $T_J$ max. $V_A = 1.5 \times V_R$ typical

## Electrical Specifications

Parameters	20CTQ	Units	Conditions
$V_{FM}$ Max. Forward Voltage Drop (Per Leg) * See Fig. 1 (1)	0.64	V	@ 10A
	0.76	V	@ 20A
	0.57	V	@ 10A
	0.68	V	@ 20A
$I_{RM}$ Max. Reverse Leakage Current (Per Leg) * See Fig. 2 (1)	2	mA	$T_J = 25^\circ\text{C}$
	15	mA	$T_J = 125^\circ\text{C}$
$C_T$ Max. Junction Capacitance (Per Leg)	900	pF	$V_R = 5V_{DC}$ (test signal range 100Khz to 1Mhz) $25^\circ\text{C}$
$L_S$ Typical Series Inductance (Per Leg)	8.0	nH	Measured lead to lead 5mm from package body
$dv/dt$ Max. Voltage Rate of Change (Rated $V_R$ )	10000	V/ $\mu\text{s}$	

(1) Pulse Width < 300 $\mu\text{s}$ , Duty Cycle <2%

## Thermal-Mechanical Specifications

Parameters	20CTQ	Units	Conditions
$T_J$ Max. Junction Temperature Range	-55 to 175	$^\circ\text{C}$	
$T_{stg}$ Max. Storage Temperature Range	-55 to 175	$^\circ\text{C}$	
$R_{thJC}$ Max. Thermal Resistance Junction to Case (Per Leg)	3.25	$^\circ\text{C}/\text{W}$	DC operation * See Fig. 4
$R_{thJC}$ Max. Thermal Resistance Junction to Case (Per Package)	1.63	$^\circ\text{C}/\text{W}$	DC operation
$R_{thCS}$ Typical Thermal Resistance, Case to Heatsink	0.50	$^\circ\text{C}/\text{W}$	Mounting surface, smooth and greased
wt Approximate Weight	2 (0.07)	g (oz.)	
T Mounting Torque	Min.	6 (5)	Kg-cm (lbf-in)
	Max.	12 (10)	

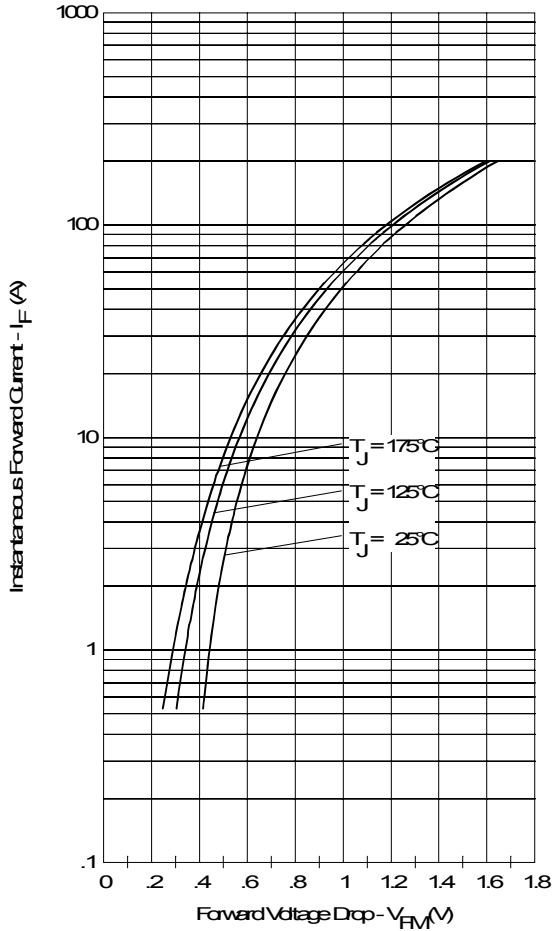

Fig. 1 - Max. Forward Voltage Drop Characteristics (Per Leg)

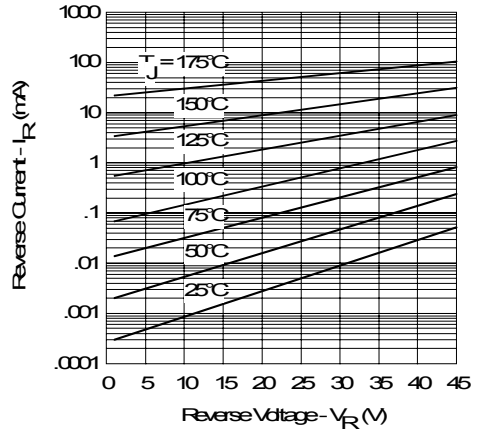

Fig. 2 - Typical Values Of Reverse Current Vs. Reverse Voltage (Per Leg)

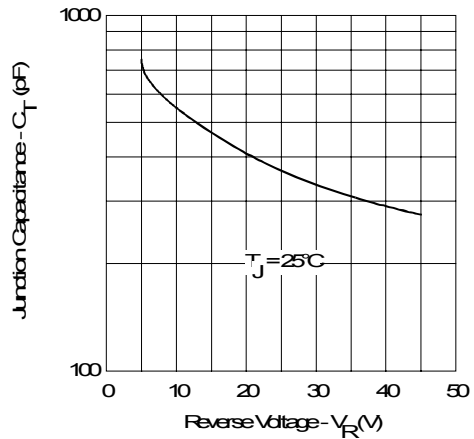

Fig. 3 - Typical Junction Capacitance Vs. Reverse Voltage (Per Leg)

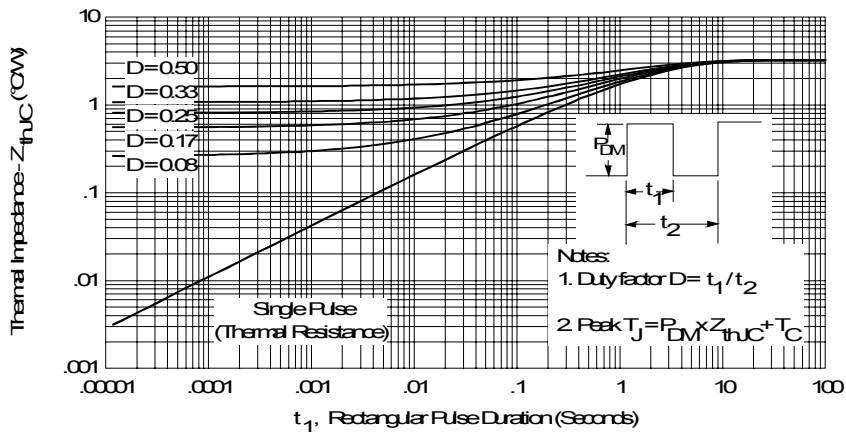

Fig. 4 - Max. Thermal Impedance  $Z_{thJC}$  Characteristics (Per Leg)

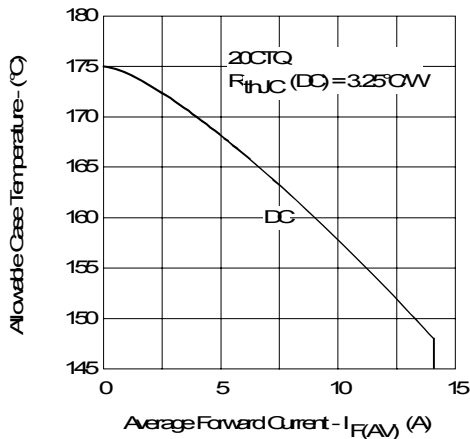

Fig. 5 - Max. Allowable Case Temperature Vs. Average Forward Current (Per Leg)

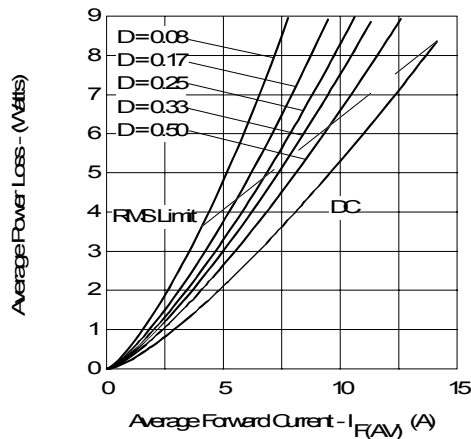

Fig. 6 - Forward Power Loss Characteristics (Per Leg)

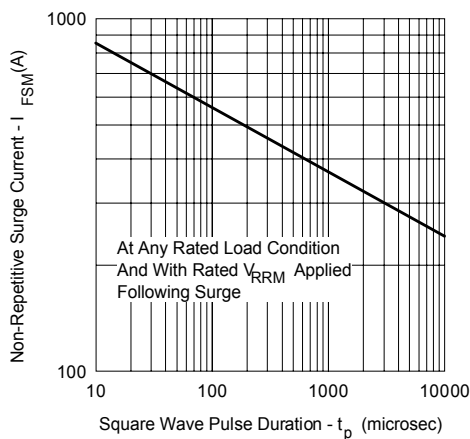

Fig. 7 - Max. Non-Repetitive Surge Current (Per Leg)

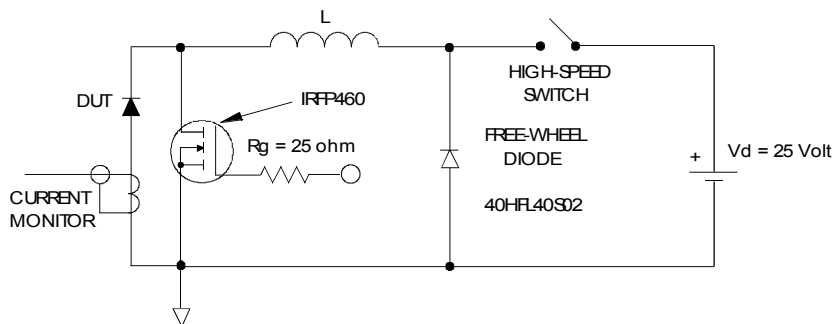
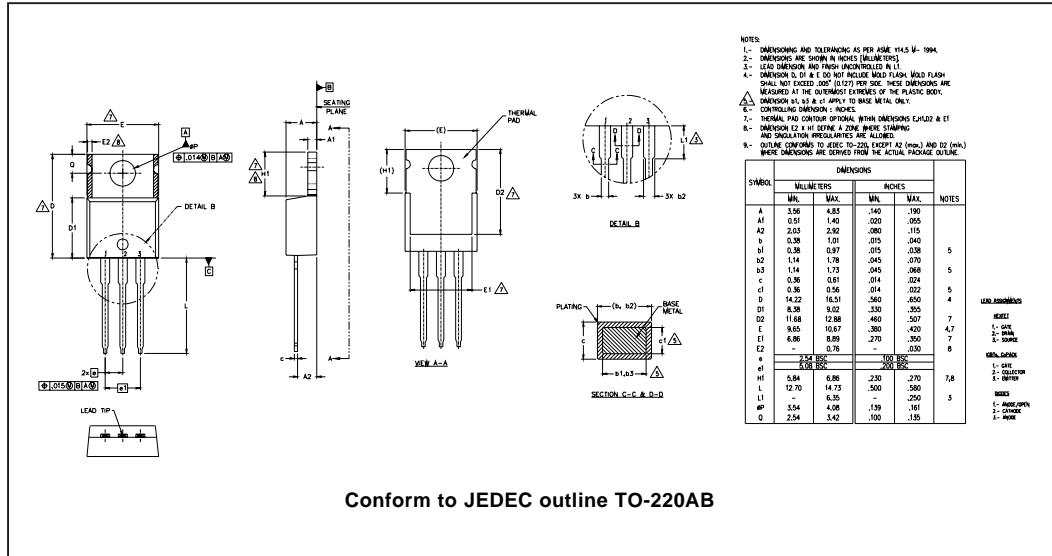
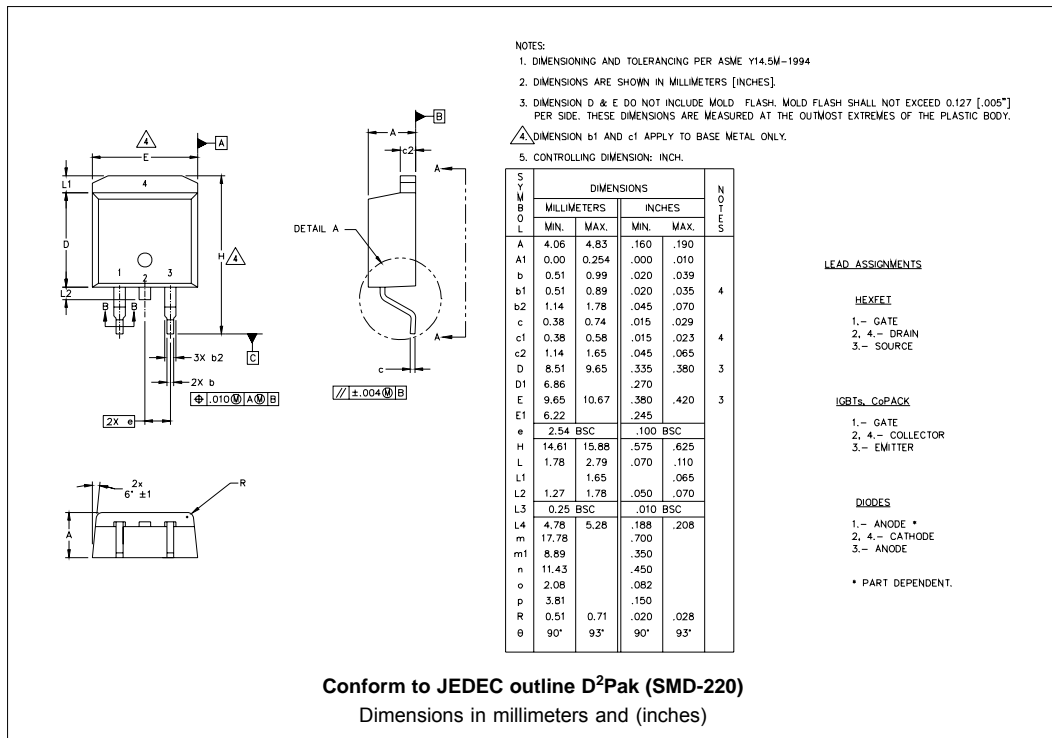

Fig. 8 - Unclamped Inductive Test Circuit

Outline Table



Conform to JEDEC outline TO-220AB



Conform to JEDEC outline D<sup>2</sup>Pak (SMD-220)  
 Dimensions in millimeters and (inches)

Outline Table

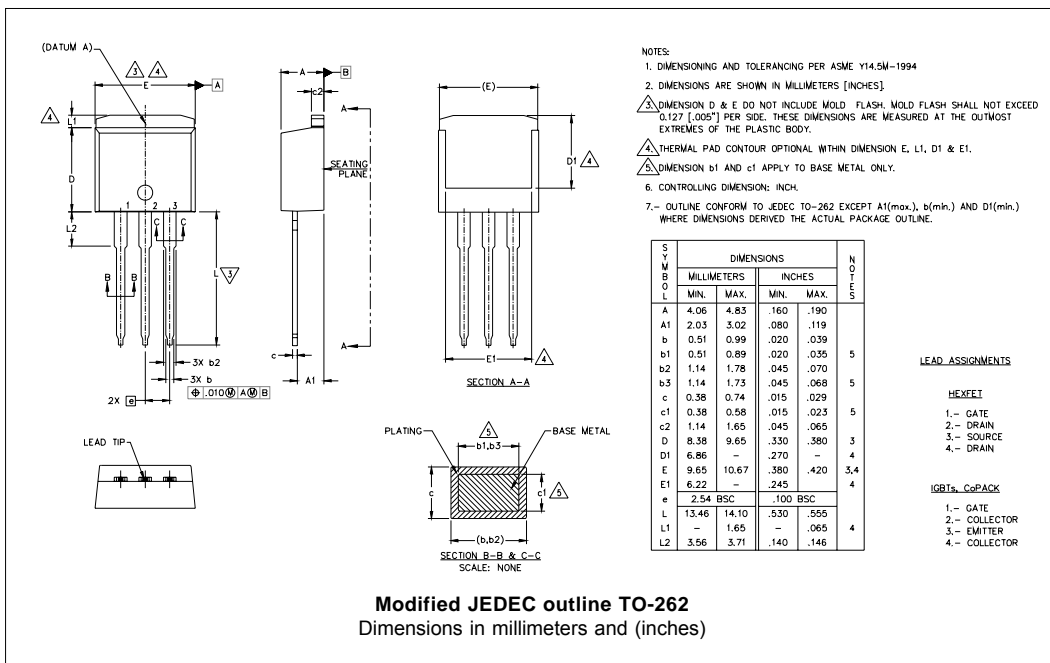

Tape & Reel Information

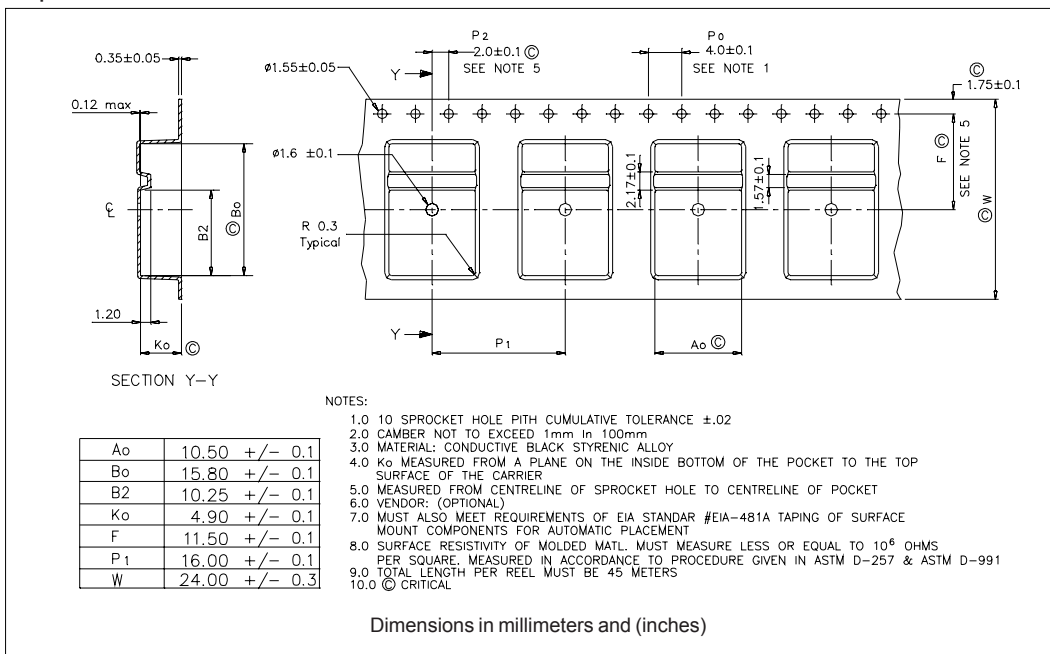

Part Marking Information

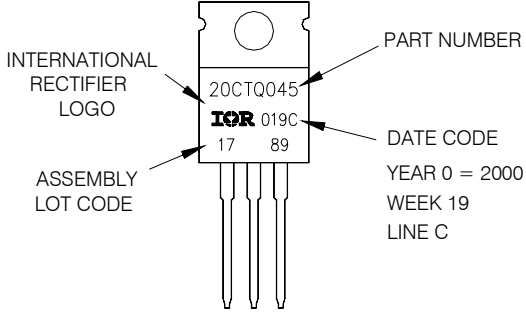
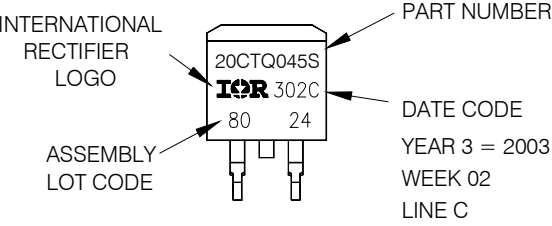
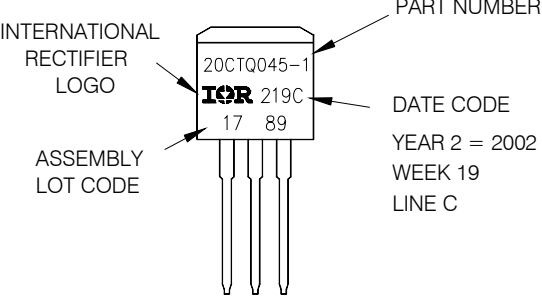
<p><b>TO-220</b></p> <p>EXAMPLE: THIS IS A 20CTQ045                  LOT CODE 1789                  ASSEMBLED ON WW 19, 2000                  IN THE ASSEMBLY LINE "C"</p>	 <p>INTERNATIONAL RECTIFIER LOGO</p> <p>ASSEMBLY LOT CODE</p> <p>PART NUMBER</p> <p>DATE CODE                  YEAR 0 = 2000                  WEEK 19                  LINE C</p>
<p><b>D<sup>2</sup>PAK</b></p> <p>EXAMPLE: THIS IS A 20CTQ045S                  LOT CODE 8024                  ASSEMBLED ON WW 02, 2003                  IN ASSEMBLY LINE "C"</p>	 <p>INTERNATIONAL RECTIFIER LOGO</p> <p>ASSEMBLY LOT CODE</p> <p>PART NUMBER</p> <p>DATE CODE                  YEAR 3 = 2003                  WEEK 02                  LINE C</p>
<p><b>TO-262</b></p> <p>EXAMPLE: THIS IS A 20CTQ045-1                  LOT CODE 1789                  ASSEMBLED ON WW 19, 2002                  IN ASSEMBLY LINE "C"</p>	 <p>INTERNATIONAL RECTIFIER LOGO</p> <p>ASSEMBLY LOT CODE</p> <p>PART NUMBER</p> <p>DATE CODE                  YEAR 2 = 2002                  WEEK 19                  LINE C</p>

Ordering Information Table

Device Code							
20	C	T	Q	045	S	TRL	-
①	②	③	④	⑤	⑥	⑦	⑧
<b>1</b>	- Current Rating (20A)						
<b>2</b>	- Circuit Configuration C = Common Cathode						
<b>3</b>	- T = TO-220						
<b>4</b>	- Schottky "Q" Series						
<b>5</b>	- Voltage Ratings						
<b>6</b>	<ul style="list-style-type: none"> <li>• S = D<sup>2</sup>Pak</li> <li>• -1= TO-262</li> </ul>						
<b>7</b>	<ul style="list-style-type: none"> <li>• none = Tube (50 pieces)</li> <li>• TRL = Tape &amp; Reel (Left Oriented - for D<sup>2</sup>Pak only)</li> <li>• TRR = Tape &amp; Reel (Right Oriented - for D<sup>2</sup>Pak only)</li> </ul>						
<b>8</b>	<ul style="list-style-type: none"> <li>• none = Standard Production</li> <li>• PbF = Lead-Free</li> </ul>						

035 = 35V  
 040 = 40V  
 045 = 45V

Data and specifications subject to change without notice.  
 This product has been designed and qualified for Industrial Level.  
 Qualification Standards can be found on IR's Web site.