

# Power MOSFET

## P20F50HP2

### 500V 20A

#### 特長

- 高耐圧
- 低オン抵抗
- 高速スイッチング
- 高アバランシェ耐量、高 di/dt 耐量

#### Feature

- High Voltage
- Low R<sub>ON</sub>
- Fast Switching
- High Avalanche durability, High di/dt durability

#### ■外観図 OUTLINE

Package : FTO-220AG (3pin)

Unit : mm

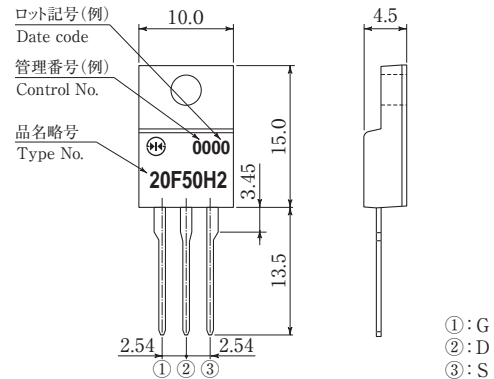

外形図については新電元 Web サイトをご参照下さい。捺印表示については捺印仕様をご確認下さい。

For details of the outline dimensions, refer to our web site. As for the marking, refer to the specification "Marking, Terminal Connection".

#### ■定格表 RATINGS

##### ●絶対最大定格 Absolute Maximum Ratings (指定のない場合 T<sub>c</sub> = 25°C / unless otherwise specified)

項目 Item	記号 Symbol	条件 Conditions	規格値 Ratings	単位 Unit
保存温度 Storage Temperature	T <sub>stg</sub>		-55~150	°C
チャネル温度 Channel Temperature	T <sub>ch</sub>		150	
ドレイン・ソース間電圧 Drain-Source Voltage	V <sub>DSS</sub>		500	V
ゲート・ソース間電圧 Gate Source Voltage	V <sub>GSS</sub>		±30	
ドレイン電流 (直流) Continuous Drain Current (DC)	I <sub>D</sub>		20	A
ドレイン電流 (ピーク) Continuous Drain Current (Peak)	I <sub>DP</sub>	パルス幅 10 μs, duty = 1/100 Pulse width 10 μs, duty = 1/100	80	
ソース電流 (直流) Continuous Source Current (DC)	I <sub>S</sub>		20	W
全損失 Total Power Dissipation	P <sub>T</sub>		95	
繰り返しアバランシェ電流 Repetitive Avalanche Current	I <sub>AR</sub>	Starting T <sub>ch</sub> = 25°C, T <sub>ch</sub> ≤ 150°C	20	A
単発アバランシェエネルギー Single Avalanche Energy	E <sub>AS</sub>	Starting T <sub>ch</sub> = 25°C, T <sub>ch</sub> ≤ 150°C	90	
繰り返しアバランシェエネルギー Repetitive Avalanche Energy	E <sub>AR</sub>	Starting T <sub>ch</sub> = 25°C, T <sub>ch</sub> ≤ 150°C	9	mJ
ドレイン・ソースダイオード耐量 Drain-Source Diode di/dt	di/dt	I <sub>S</sub> = 20A, T <sub>c</sub> = 25°C	350	
絶縁耐圧 Dielectric Strength	V <sub>dis</sub>	一括端子・ケース間, AC 1 分間印加 Terminals to case, AC 1 minute (推奨値: 0.3N・m)	2	kV
締め付けトルク Mounting Torque	TOR	(推奨値: 0.3N・m)	0.5	N・m

##### ●電氣的・熱的特性 Electrical Characteristics (指定のない場合 T<sub>c</sub> = 25°C / unless otherwise specified)

項目 Item	記号 Symbol	条件 Conditions	規格値 Ratings			単位 Unit
			MIN	TYP	MAX	
ドレイン・ソース間降伏電圧 Drain-Source Breakdown Voltage	V <sub>(BR)DSS</sub>	I <sub>D</sub> = 1mA, V <sub>GS</sub> = 0V	500	—	—	V
ドレイン遮断電流 Zero Gate Voltage Drain Current	I <sub>DSS</sub>	V <sub>DS</sub> = 500V, V <sub>GS</sub> = 0V	—	—	100	μA
ゲート漏れ電流 Gate-Source Leakage Current	I <sub>GSS</sub>	V <sub>GS</sub> = ±30V, V <sub>DS</sub> = 0V	—	—	±0.1	
順伝達コンダクタンス Forward Transconductance	g <sub>fs</sub>	I <sub>D</sub> = 10A, V <sub>DS</sub> = 10V	10	20.5	—	S
ドレイン・ソース間オン抵抗 Static Drain-Source On-state Resistance	R <sub>(DS)ON</sub>	I <sub>D</sub> = 10A, V <sub>GS</sub> = 10V	—	0.29	0.36	Ω
ゲートしきい値電圧 Gate Threshold Voltage	V <sub>TH</sub>	I <sub>D</sub> = 1mA, V <sub>DS</sub> = 10V	3.0	3.75	4.5	
ソース・ドレイン間ダイオード順電圧 Source-Drain Diode Forward Voltage	V <sub>SD</sub>	I <sub>S</sub> = 10A, V <sub>GS</sub> = 0V	—	—	1.5	V
熱抵抗 Thermal Resistance	θ <sub>jc</sub>	接合部・ケース間 Junction to case	—	—	1.32	
ゲート全電荷量 Total Gate Charge	Q <sub>g</sub>	V <sub>DD</sub> = 400V, V <sub>GS</sub> = 10V, I <sub>D</sub> = 20A	—	40	—	nC
入力容量 Input Capacitance	C <sub>iss</sub>	V <sub>DS</sub> = 50V, V <sub>GS</sub> = 0V, f = 1MHz	—	1735	—	
帰還容量 Reverse Transfer Capacitance	C <sub>rss</sub>		—	10	—	pF
出力容量 Output Capacitance	C <sub>oss</sub>		—	176	—	
ターンオン遅延時間 Turn-on delay time	t <sub>d(on)</sub>	I <sub>D</sub> = 10A, R <sub>L</sub> = 15Ω, V <sub>DD</sub> = 150V, R <sub>g</sub> = 50Ω, V <sub>GS(+)</sub> = 10V, V <sub>GS(-)</sub> = 0V	—	35	—	ns
上昇時間 Rise time	t <sub>r</sub>		—	63	—	
ターンオフ遅延時間 Turn-off delay time	t <sub>d(off)</sub>		—	140	—	
降下時間 Fall time	t <sub>f</sub>		—	50	—	

■特性図 CHARACTERISTIC DIAGRAMS

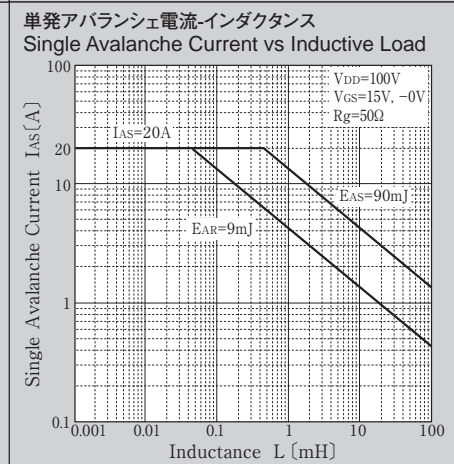
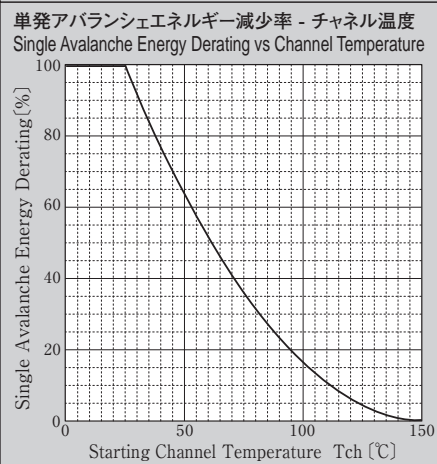
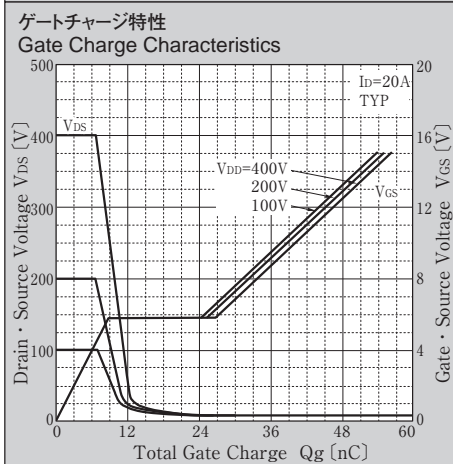
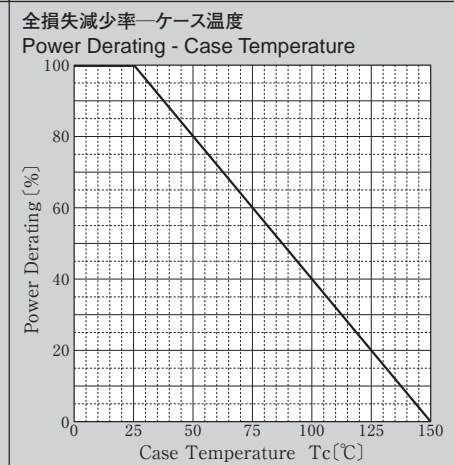
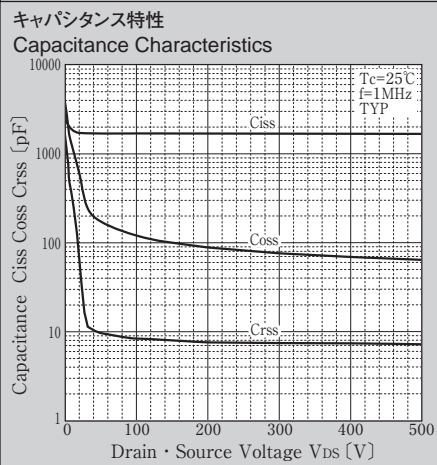
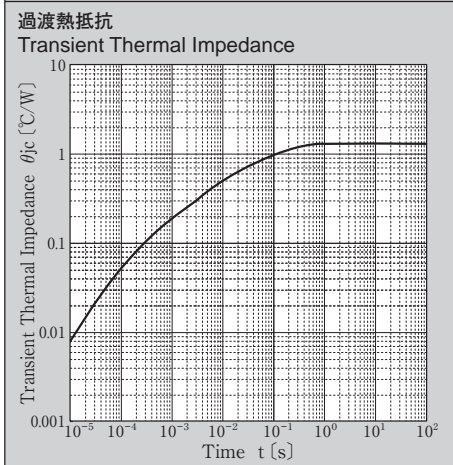
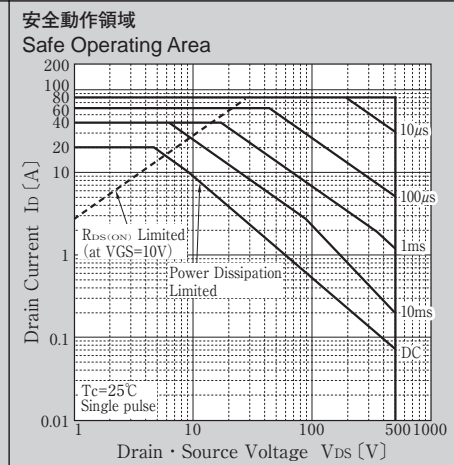
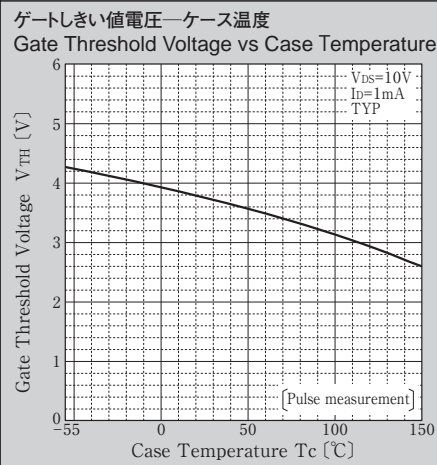
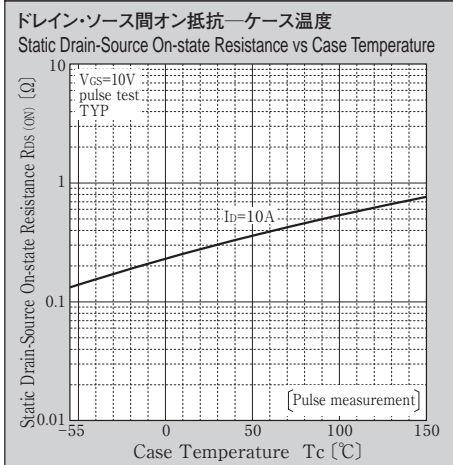
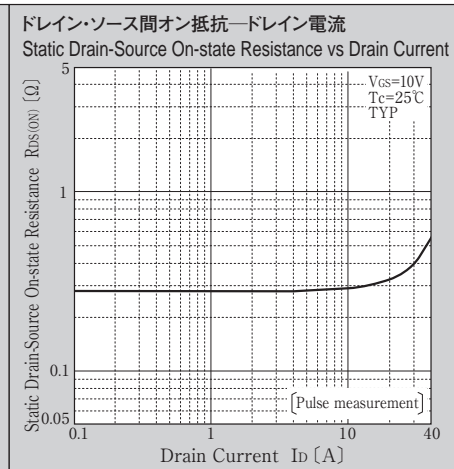
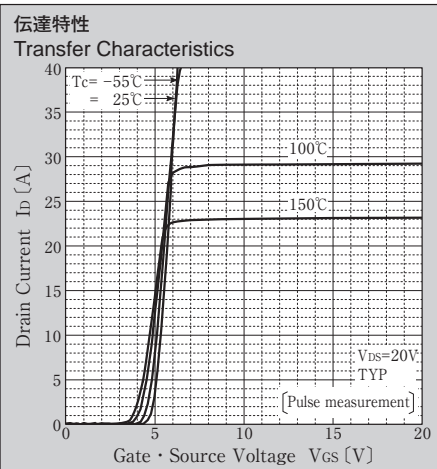
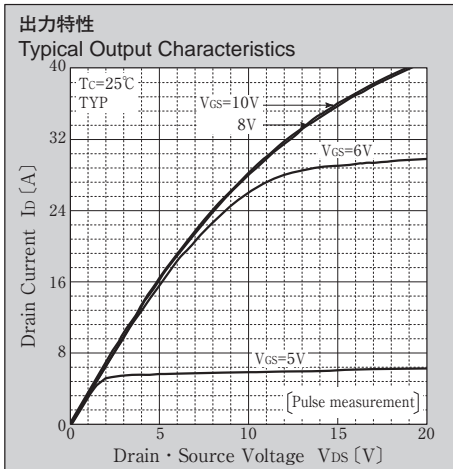

\* Sine wave は 50Hz で測定しています。  
\* 50Hz sine wave is used for measurements.