

# 20DL2CZ47A, 20FL2CZ47A

SWITCHING MODE POWER SUPPLY APPLICATION  
 CONVERTER & CHOPPER APPLICATION

- Repetitive Peak Reverse Voltage :  $V_{RRM} = 200\text{ V}, 300\text{ V}$
- Average Output Rectified Current :  $I_O = 20\text{ A}$
- Ultra Fast Reverse-Recovery Time :  $t_{rr} = 35\text{ ns (Max)}$
- Low Switching Losses and Low Output Noise

## MAXIMUM RATINGS (Ta = 25°C)

CHARACTERISTIC		SYMBOL	RATING	UNIT
Repetitive Peak Reverse Voltage	20DL2CZ47A	$V_{RRM}$	200	V
	20FL2CZ47A		300	
Average Output Rectified Current (Full Sine Waveform)		$I_O$	20	A
Peak One Cycle Surge Forward Current (Non-Repetitive)		$I_{FSM}$	100 (50Hz)	A
			110 (60Hz)	
Junction Temperature		$T_j$	-40~150	°C
Storage Temperature Range		$T_{stg}$	-40~150	°C
Screw Torque		—	0.6	N·m

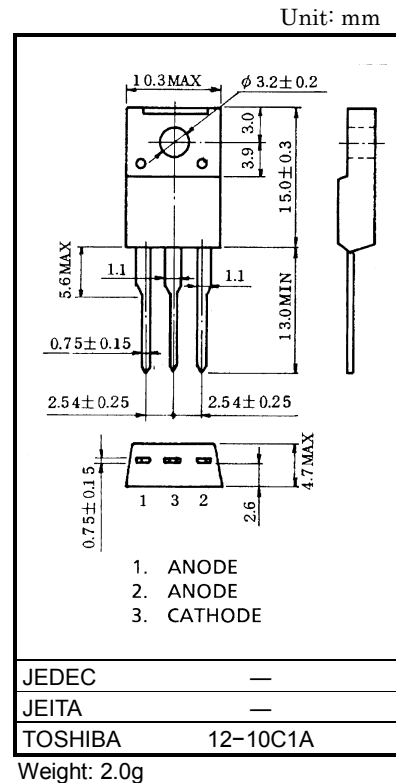

## ELECTRICAL CHARACTERISTICS (Ta = 25°C)

CHARACTERISTIC		SYMBOL	TEST CONDITION	MIN	TYP.	MAX	UNIT
Peak Forward Voltage (Note 1)	20DL2CZ47A	$V_{FM}$	$I_{FM} = 10\text{ A}$	—	—	0.98	V
	20FL2CZ47A			—	—	1.3	
Repetitive Peak Reverse Current (Note 1)		$I_{RRM}$	$V_{RRM} = \text{Rated}$	—	—	50	μA
Reverse Recovery Time (Note 1)		$t_{rr}$	$I_F = 2.0\text{ A}, di / dt = -50\text{ A} / \mu\text{s}$	—	—	35	ns
Forward Recovery Time (Note 1)		$t_{fr}$	$I_F = 1.0\text{ A}$	—	—	100	ns
Thermal Resistance		$R_{th(j-c)}$	DC Total, Junction to Case	—	—	3.0	°C / W

Note 1: A value applied to one cell.

## POLARITY

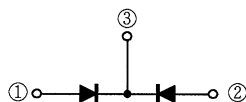

## MARKING

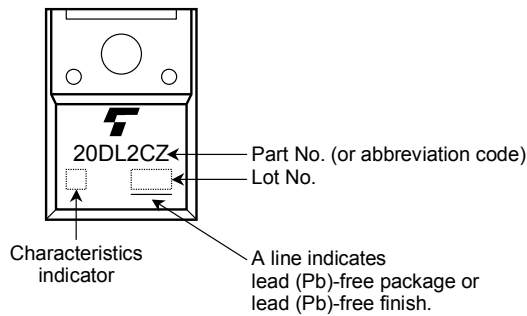

Abbreviation Code	Part No.
20DL2CZ	20DL2CZ47A
20FL2CZ	20FL2CZ47A

## Handling Precaution

The maximum ratings denote the absolute maximum ratings, which are rated values and must not be exceeded during operation, even for an instant. The following are the general derating methods that we recommend when you design a circuit with a device.

**VRRM:** We recommend that the worst case voltage, including surge voltage, be no greater than 80% of the maximum rating of VRRM for a DC circuit and be no greater than 50% of that of VRRM for an AC circuit. VRRM has a temperature coefficient of 0.1%/°C. Take this temperature coefficient into account designing a device at low temperature.

**IO:** We recommend that the worst case current be no greater than 80% of the maximum rating of IO. Carry out adequate heat design. If you can't design a circuit with excellent heat radiation, set the margin by using an allowable Tamax-IO curve.

This rating specifies the non-repetitive peak current in one cycle of a 50-Hz sine wave, condition angle 180. Therefore, this is only applied for an abnormal operation, which seldom occurs during the lifespan of the device.

We recommend that a device be used at a Tj of below 120°C under the worst load and heat radiation conditions.

Please refer to the Rectifiers databook for further information.

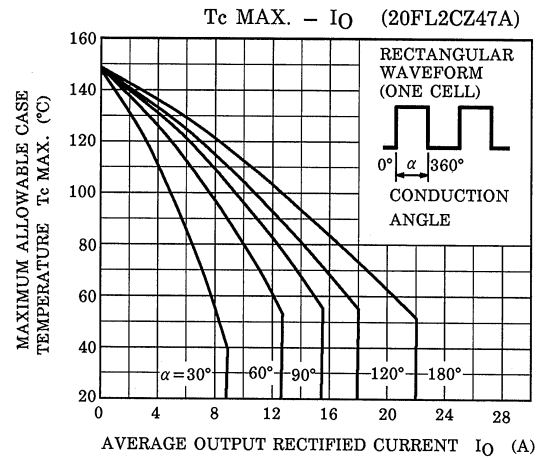
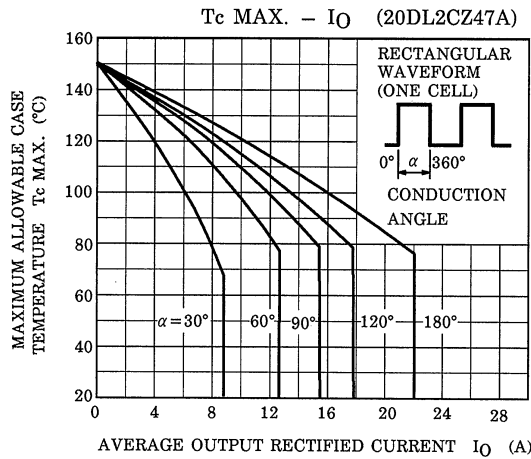
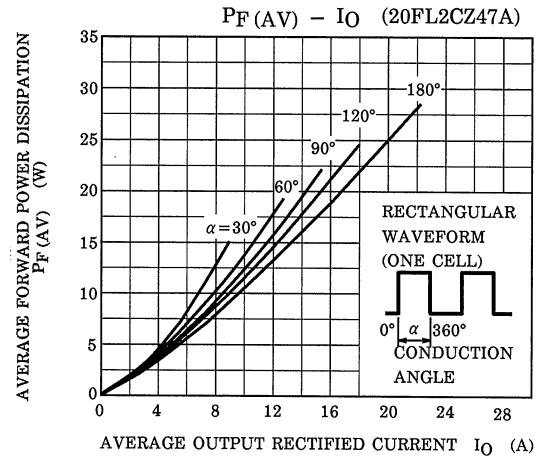
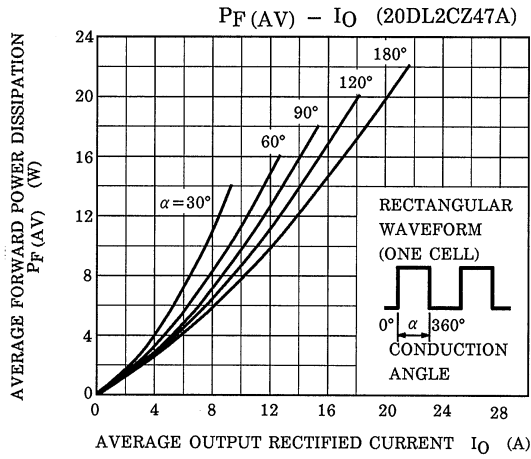
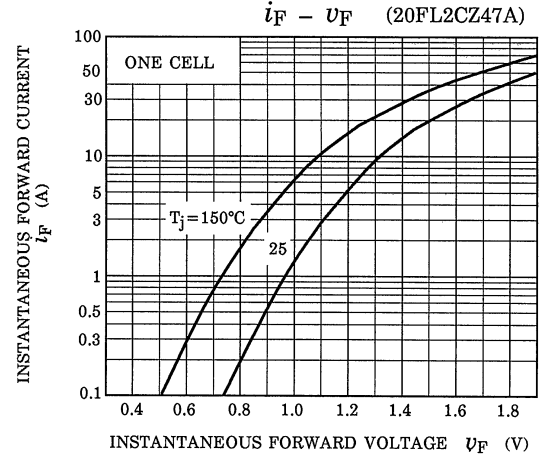
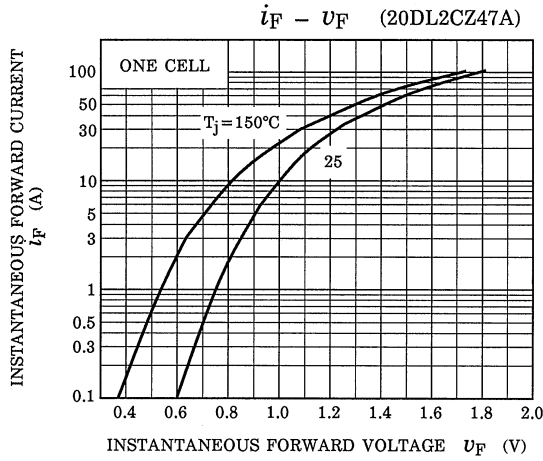

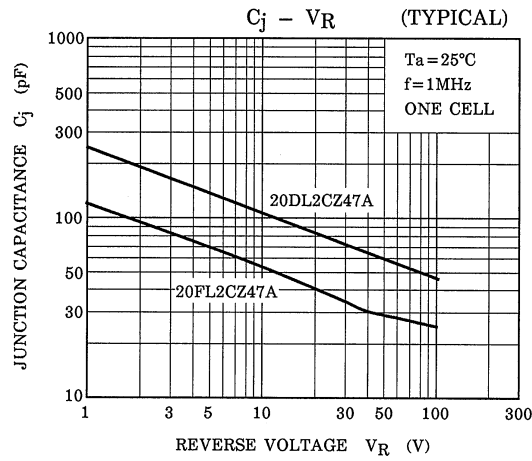
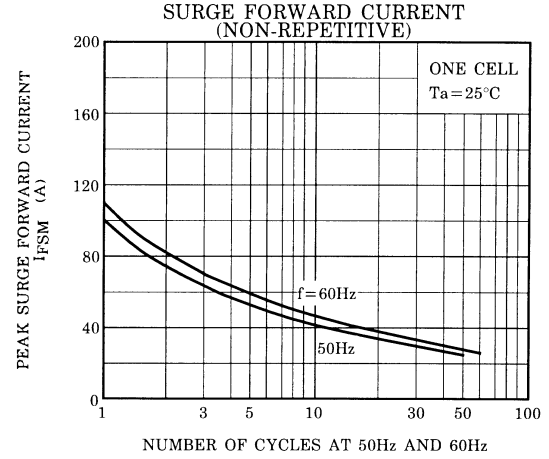
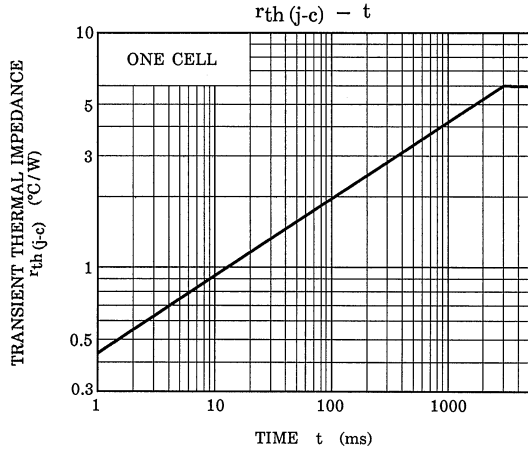

**RESTRICTIONS ON PRODUCT USE**

030619EAA

- The information contained herein is subject to change without notice.
- The information contained herein is presented only as a guide for the applications of our products. No responsibility is assumed by TOSHIBA for any infringements of patents or other rights of the third parties which may result from its use. No license is granted by implication or otherwise under any patent or patent rights of TOSHIBA or others.
- TOSHIBA is continually working to improve the quality and reliability of its products. Nevertheless, semiconductor devices in general can malfunction or fail due to their inherent electrical sensitivity and vulnerability to physical stress. It is the responsibility of the buyer, when utilizing TOSHIBA products, to comply with the standards of safety in making a safe design for the entire system, and to avoid situations in which a malfunction or failure of such TOSHIBA products could cause loss of human life, bodily injury or damage to property.  
In developing your designs, please ensure that TOSHIBA products are used within specified operating ranges as set forth in the most recent TOSHIBA products specifications. Also, please keep in mind the precautions and conditions set forth in the "Handling Guide for Semiconductor Devices," or "TOSHIBA Semiconductor Reliability Handbook" etc..
- The TOSHIBA products listed in this document are intended for usage in general electronics applications (computer, personal equipment, office equipment, measuring equipment, industrial robotics, domestic appliances, etc.). These TOSHIBA products are neither intended nor warranted for usage in equipment that requires extraordinarily high quality and/or reliability or a malfunction or failure of which may cause loss of human life or bodily injury ("Unintended Usage"). Unintended Usage include atomic energy control instruments, airplane or spaceship instruments, transportation instruments, traffic signal instruments, combustion control instruments, medical instruments, all types of safety devices, etc.. Unintended Usage of TOSHIBA products listed in this document shall be made at the customer's own risk.
- TOSHIBA products should not be embedded to the downstream products which are prohibited to be produced and sold, under any law and regulations.