

# CoolMOS™ 1) Power MOSFET

N-Channel Enhancement Mode  
 Low  $R_{DS(on)}$ , High  $V_{DSS}$  MOSFET  
 Ultra low gate charge

$I_{D25}$  = 20 A  
 $V_{DSS}$  = 600 V  
 $R_{DS(on)max}$  = 0.2  $\Omega$

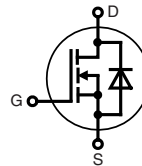

TO-247 AD (IXKH)

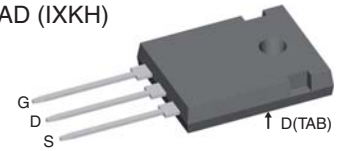

TO-220 AB (IXKP)

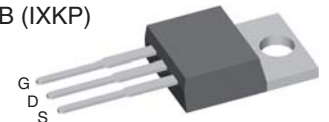

MOSFET			
Symbol	Conditions	Maximum Ratings	
$V_{DSS}$	$T_{VJ} = 25^{\circ}\text{C}$	600	V
$V_{GS}$		$\pm 20$	V
$I_{D25}$	$T_C = 25^{\circ}\text{C}$	20	A
$I_{D90}$	$T_C = 90^{\circ}\text{C}$	13	A
$E_{AS}$ $E_{AR}$	single pulse repetitive } $I_D = 6.6 \text{ A}; T_C = 25^{\circ}\text{C}$	435 0.66	mJ mJ
$dV/dt$	MOSFET $dV/dt$ ruggedness $V_{DS} = 0 \dots 480 \text{ V}$	50	V/ns

## Features

- fast CoolMOS™ 1) power MOSFET
- 4th generation
- High blocking capability
- Lowest resistance
- Avalanche rated for unclamped inductive switching (UIS)
- Low thermal resistance due to reduced chip thickness
- Enhanced total power density

## Applications

- Switched mode power supplies (SMPS)
- Uninterruptible power supplies (UPS)
- Power factor correction (PFC)
- Welding
- Inductive heating
- PDP and LCD adapter

Symbol	Conditions	Characteristic Values			
		$(T_{VJ} = 25^{\circ}\text{C}, \text{ unless otherwise specified})$			
		min.	typ.	max.	
$R_{DS(on)}$	$V_{GS} = 10 \text{ V}; I_D = 10 \text{ A}$		180	200	m $\Omega$
$V_{GS(th)}$	$V_{DS} = V_{GS}; I_D = 1.1 \text{ mA}$	2.5	3	3.5	V
$I_{DSS}$	$V_{DS} = 600 \text{ V}; V_{GS} = 0 \text{ V}$			1	$\mu\text{A}$
			10		$\mu\text{A}$
$I_{GSS}$	$V_{GS} = \pm 20 \text{ V}; V_{DS} = 0 \text{ V}$			100	nA
$C_{iss}$ $C_{oss}$	$V_{GS} = 0 \text{ V}; V_{DS} = 100 \text{ V}$ $f = 1 \text{ MHz}$		1520 72		pF pF
$Q_g$ $Q_{gs}$ $Q_{gd}$	$V_{GS} = 0 \text{ to } 10 \text{ V}; V_{DS} = 400 \text{ V}; I_D = 10 \text{ A}$		32 8 11	45	nC nC nC
$t_{d(on)}$ $t_r$ $t_{d(off)}$ $t_f$	$V_{GS} = 10 \text{ V}; V_{DS} = 400 \text{ V}$ $I_D = 10 \text{ A}; R_G = 3.3 \Omega$		10 5 50 5		ns ns ns ns
$R_{thJC}$				0.60	K/W

<sup>1)</sup> CoolMOS™ is a trademark of Infineon Technologies AG.

**Source-Drain Diode**

Symbol	Conditions	Characteristic Values			
		min.	typ.	max.	
( $T_{VJ} = 25^{\circ}\text{C}$ , unless otherwise specified)					
$I_S$	$V_{GS} = 0\text{ V}$			10	A
$V_{SD}$	$I_F = 10\text{ A}; V_{GS} = 0\text{ V}$		0.9	1.2	V
$t_{rr}$	} $I_F = 10\text{ A}; -di_F/dt = 100\text{ A}/\mu\text{s}; V_R = 400\text{ V}$		340		ns
$Q_{RM}$			5.5		$\mu\text{C}$
$I_{RM}$			33		A

**Component**

Symbol	Conditions	Maximum Ratings		
$T_{VJ}$	operating		-55...+150	$^{\circ}\text{C}$
$T_{stg}$			-55...+150	$^{\circ}\text{C}$
$M_d$	mounting torque	TO-247	0.8 ... 1.2	Nm
		TO-220	0.4 ... 0.6	Nm

Symbol	Conditions	Characteristic Values			
		min.	typ.	max.	
$R_{thCH}$	with heatsink compound	TO-247	0.25		K/W
		TO-220	0.50		K/W
Weight	TO-247		6		g
	TO-220		2		g

### TO-247 AD Outline

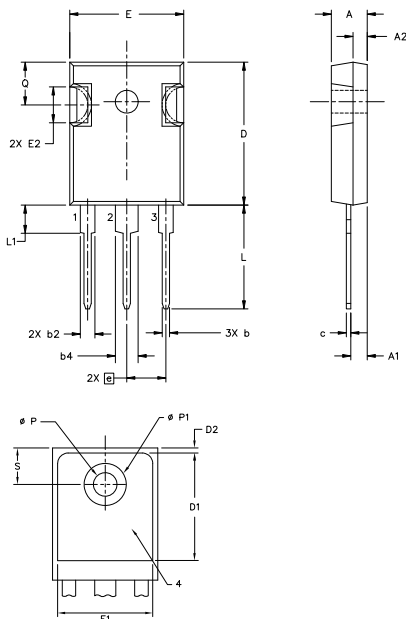

Symbol	Inches		Millimeters	
	min	max	min	max
A	0.185	0.209	4.70	5.30
A1	0.087	0.102	2.21	2.59
A2	0.059	0.098	1.50	2.49
D	0.819	0.845	20.79	21.45
E	0.610	0.640	15.48	16.24
E2	0.170	0.216	4.31	5.48
e	0.215 BSC		5.46 BSC	
L	0.780	0.800	19.80	20.30
L1	-	0.177	-	4.49
ØP	0.140	0.144	3.55	3.65
Q	0.212	0.244	5.38	6.19
S	0.242 BSC		6.14 BSC	
b	0.039	0.055	0.99	1.40
b2	0.065	0.094	1.65	2.39
b4	0.102	0.135	2.59	3.43
c	0.015	0.035	0.38	0.89
D1	0.515	-	13.07	-
D2	0.020	0.053	0.51	1.35
E1	0.530	-	13.45	-
ØP1	-	0.291	-	7.39

### TO-220 AB Outline

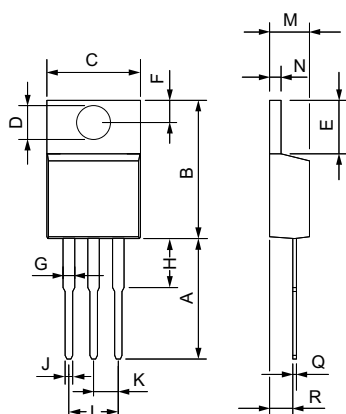

Dim.	Millimeter		Inches	
	Min.	Max.	Min.	Max.
A	12.70	13.97	0.500	0.550
B	14.73	16.00	0.580	0.630
C	9.91	10.66	0.390	0.420
D	3.54	4.08	0.139	0.161
E	5.85	6.85	0.230	0.270
F	2.54	3.18	0.100	0.125
G	1.15	1.65	0.045	0.065
H	2.79	5.84	0.110	0.230
J	0.64	1.01	0.025	0.040
K	2.54	BSC	0.100	BSC
M	4.32	4.82	0.170	0.190
N	1.14	1.39	0.045	0.055
Q	0.35	0.56	0.014	0.022
R	2.29	2.79	0.090	0.110

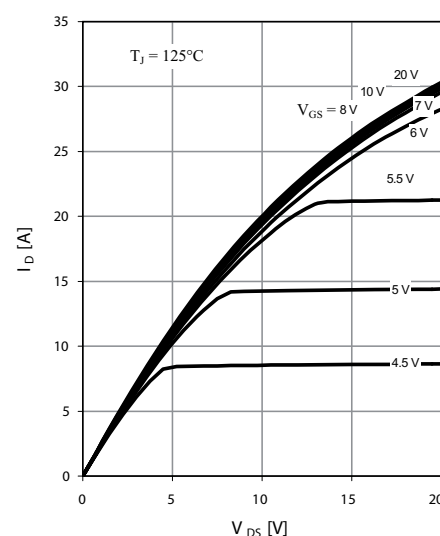
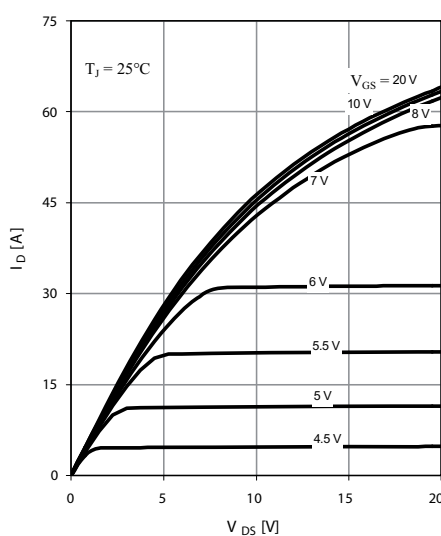
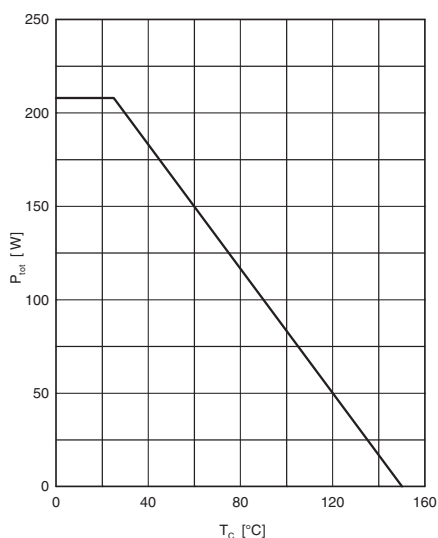

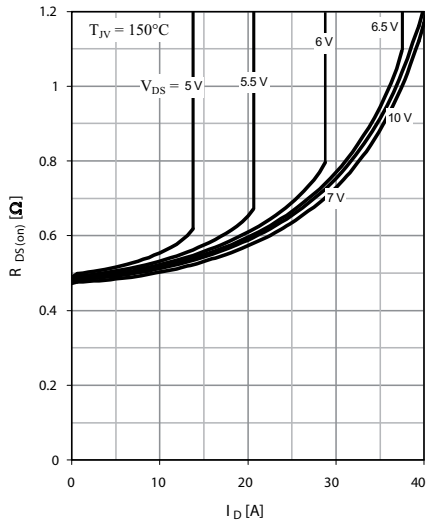

Fig. 4 Typ. drain-source on-state resistance characteristics of IGBT

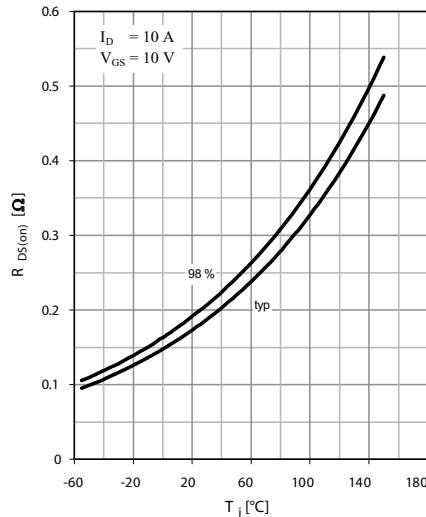

Fig. 5 Drain-source on-state resistance

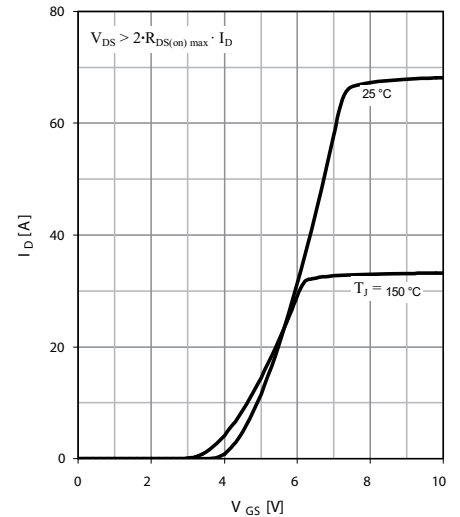

Fig. 6 Typ. transfer characteristics

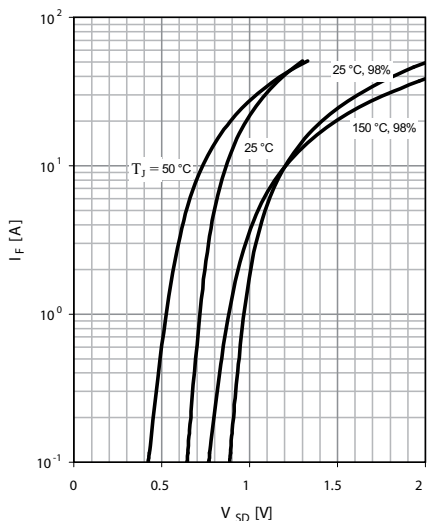

Fig. 7 Forward characteristic of reverse diode

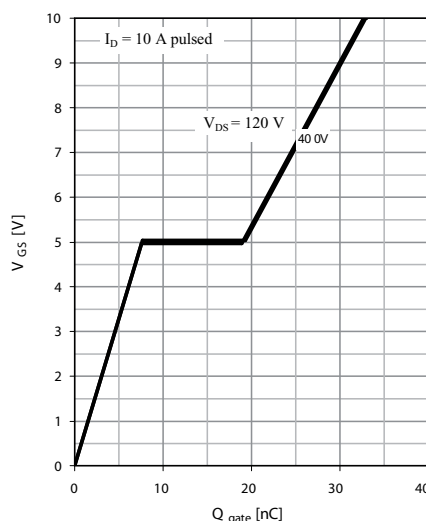

Fig. 8 Typ. gate charge

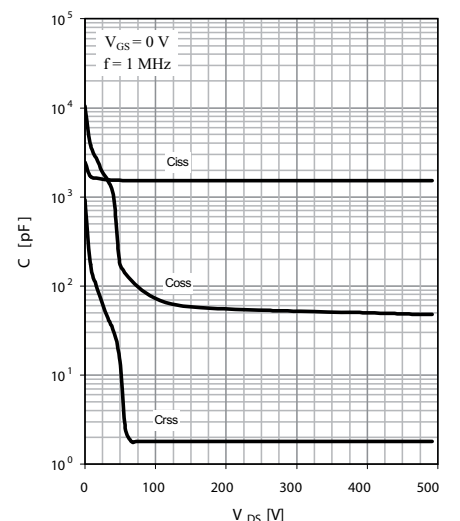

Fig. 9 Typ. capacitances

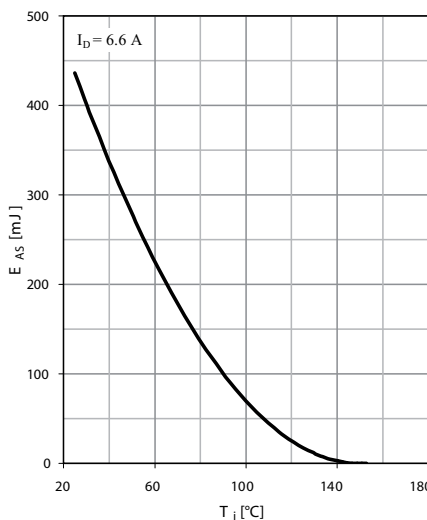

Fig. 10 Avalanche energy

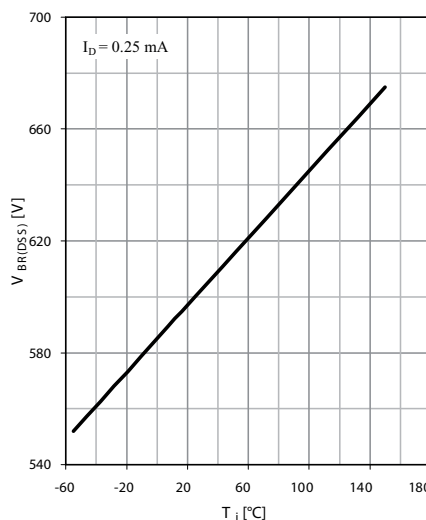

Fig. 11 Drain-source breakdown voltage

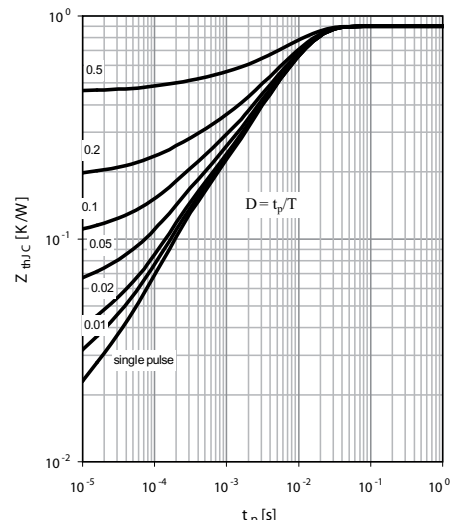

Fig. 12 Max. transient thermal impedance

IXYS reserves the right to change limits, test conditions and dimensions.

20080523d