

4855452 INTERNATIONAL RECTIFIER

55C 04931 0

Data Sheet No. PD-2.085

7-61-19

INTERNATIONAL RECTIFIER 

21PT SERIES

20 Amp Encapsulated Rectifier Diodes

Major Ratings and Characteristics

	21PT	Units
$I_F(AV)$	20	A
@ T_{tab}	110	°C
I_{FSM}	50Hz	300 A
	60Hz	314 A
I^2t	50Hz	450 A^2s
	60Hz	411 A^2s
$I^2\sqrt{t}$	6 365	$A^2\sqrt{s}$
V_{RRM} Range	50 to 600	V
T_J Range	-40 to 150	°C

Features

- High current, small physical size
- Substantial surge current
- Heatsink or printed circuit mounting
- High moisture resistance

B

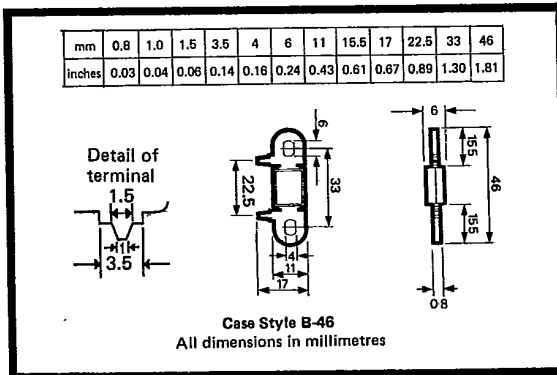
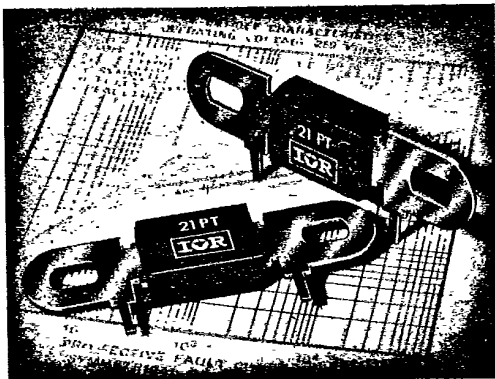

4855452 INTERNATIONAL RECTIFIER

55C 04932 D



21PT Series

T-01-19

ELECTRICAL SPECIFICATIONS

Reverse voltage ratings

Part number	V_{RRM} - Maximum peak repetitive reverse voltage $T_J = T_{J\ max}$	V_{RSM} - Maximum peak non-repetitive reverse voltage $T_J = T_{J\ max}$	I_{RM} - Maximum peak reverse leakage current at rated V_{RRM} $T_J = T_{J\ max}$
	(V)	(V)	(mA)
21PT5	50	75	8
21PT10	100	150	8
21PT20	200	275	8
21PT40	400	600	6
21PT60	600	725	4

Forward conduction

		21PT..	Units	Conditions
$I_{F(AV)}$	Maximum average forward current	20	A	$T_{tab} = 110^\circ C$, 180° sine wave conduction
I_{FSM}	Maximum peak, one cycle non-repetitive forward current	357	A	$t = 10ms$ Sinusoidal half wave 100% rated V_{RRM} reapplied initial $T_J = 150^\circ C$
		373	A	$t = 8.3ms$
		300	A	$t = 10ms$ Sinusoidal half wave no voltage reapplied Initial $T_J = 150^\circ C$
		314	A	$t = 8.3ms$
I^2t	Maximum I^2t for fusing	636	A^2s	$t = 10ms$ 100% rated V_{RRM} reapplied Initial $T_J = 150^\circ C$
		581	A^2s	$t = 8.3ms$
		450	A^2s	$t = 10ms$ No voltage reapplied Initial $T_J = 150^\circ C$
		411	A^2s	$t = 8.3ms$
$I^2\sqrt{t}$	Maximum $I^2\sqrt{t}$ for individual device fusing. ①	6365	$A^2\sqrt{s}$	$t = 0.1$ to 10ms, no voltage reapplied
$V_{F(TO)}$	Maximum value of threshold voltage	0.84	V	$T_J = 150^\circ C$
r_F	Maximum value of forward slope resistance	4.333	$m\Omega$	
V_{FM}	Maximum peak forward voltage	1.20	V	$I_{FM} = \pi \times$ rated $I_{F(AV)}$, $T_J = 25^\circ C$.

① I^2t for time $t_x = I^2\sqrt{t} \cdot \sqrt{t_x}$.

THERMAL AND MECHANICAL SPECIFICATIONS

		21PT..	Units	Conditions
T_{stg}	Maximum operating junction and storage temperature ranges.	-40 to 150	$^\circ C$	
R_{thJT}	Maximum thermal resistance, junction to tabs	2	K/W	Both tabs cooled.
wt	Approximate weight	4	g	

4855452 INTERNATIONAL RECTIFIER

55C 04933 D

21PT Series

INTERNATIONAL RECTIFIER 

T-01-19

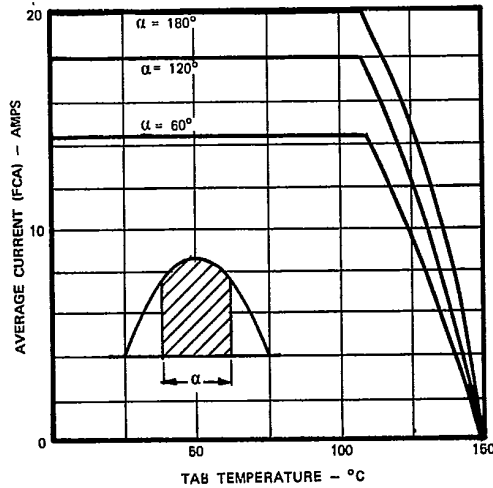

Fig. 1 - Forward Current Vs. Tab Temperature

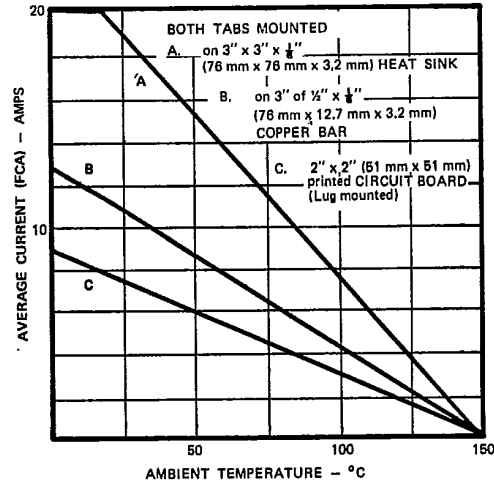

Fig. 2 - Forward Current Vs. Ambient Temperature

B

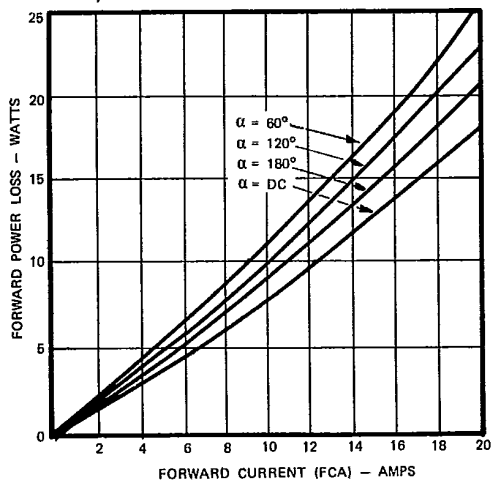

Fig. 3 - Power Loss Vs. Forward Current

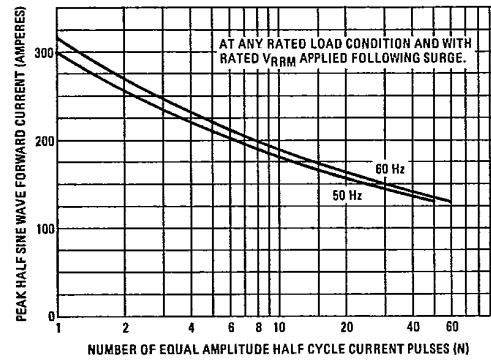

Fig. 4 - Maximum Non-Repetitive Surge Current Vs. Number of Current Pulses

4855452 INTERNATIONAL RECTIFIER

55C 04934 D

Data Sheet No. PD-2.086

T-01-19 T-01-21

INTERNATIONAL RECTIFIER 

4AF, 8AF SERIES

25 and 50 Amp Pressfit Rectifier Diodes

Major Ratings and Characteristics

	4AF...	8AF...	Units
$I_F(AV)$	25	50	A
@ Max T_C	150	150	°C
$I_F(RMS)$	39	79	A
I_{FSM}	50Hz	300	A
	60Hz	314	A
I^2_t	50Hz	450	A ² s
	60Hz	411	A ² s
$I^2\sqrt{t}$	6 365	25 455	A ² √s
V_{RRM} range	50 to 600	50 to 400	V
T_J range	-65 to 175	-65 to 195	°C

Features and Descriptions

- Convenient pressfit package.
- Available with or without leads.
- High surge capabilities.
- Fully characterised bulletin.

B

CASE STYLE AND DIMENSIONS



"PP" outline code

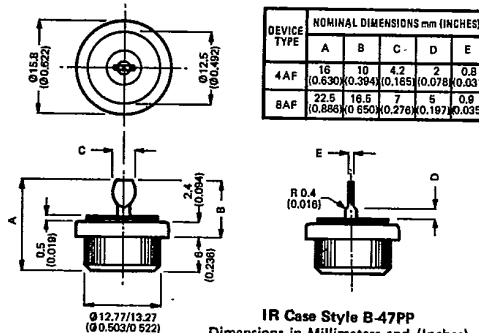

4855452 INTERNATIONAL RECTIFIER

55C 04935 D

4AF, 8AF Series

INTERNATIONAL RECTIFIER 

ELECTRICAL SPECIFICATIONS

Reverse voltage ratings

Part number*		V_{RRM} , Maximum peak repetitive reverse voltage, $T_J = T_J \text{ max}$	V_{RSM} , Maximum peak non-repetitive reverse voltage, $T_J = T_J \text{ max}$	I_{FM} Maximum peak reverse leakage current at rated V_{RRM} , $T_J = T_J \text{ max}$	
		V	V	mA (4AF)	mA (8AF)
4AF05...	8AF05...	50	75	6	7
4AF1...	8AF1...	100	150	6	7
4AF2...	8AF2...	200	300	6	5
4AF4...	8AF4...	400	500	4	5
4AF6...		600	700	4	

* To complete part number add polarity coding and outline code. For polarity add "N" for case cathode or "R" for case anode. For outline coding refer to outline drawings. I.e. 4AF4... with case cathode and flat lug complete code is 4AF4NPP.

Forward conduction

		4AF....	8AF....	Units	Conditions
I_{FRM}	Maximum peak repetitive forward current	137	277	A	180° conduction, half sine wave max. $T_C = 150^\circ\text{C}$
I_{FSM}	Maximum peak, one cycle non-repetitive forward current	357	714	A	$t = 10\text{ms}$ Sinusoidal half-wave 100% rated V_{RRM} reapplied, initial $T_J = T_J \text{ max}$.
		373	747	A	$t = 8.3\text{ms}$
		300	600	A	$t = 10\text{ms}$ Sinusoidal half-wave no voltage reapplied, initial $T_J = T_J \text{ max}$
		314	628	A	$t = 8.3\text{ms}$
I^2t	Maximum I^2t for fusing	636	2546	A^2s	$t = 10\text{ms}$ 100% rated V_{RRM} reapplied initial $T_J = T_J \text{ max}$
		581	2324	A^2s	$t = 8.3\text{ms}$
		450	1800	A^2s	$t = 10\text{ms}$ No voltage reapplied initial $T_J = T_J \text{ max}$
	Maximum I^2t for individual device fusing.	411	1643	A^2s	$t = 8.3\text{ms}$
$I^2\sqrt{t}$	Maximum $I^2\sqrt{t}$ for, individual device fusing $\text{\textcircled{1}}$	6365	25455	$\text{A}^2/\sqrt{\text{s}}$	$t = 0.1$ to 10ms , no voltage reapplied
$V_{F(TO)}$	Maximum value of threshold voltage	0.84	0.75	V	$T_J = 175^\circ\text{C}$ (4AF)
r_F	Maximum value of forward slope resistance	4.333	5.148	$\text{m}\Omega$	$T_J = 195^\circ\text{C}$ (8AF)
V_{FM}	Maximum peak forward voltage	1.25	1.45	V	$T_J = 25^\circ\text{C}$, $I_{FM} = \pi \times \text{rated } I_{F(AV)}$

$\text{\textcircled{1}} I^2t$ for time $t_x = I^2\sqrt{t} \cdot \sqrt{t_x}$.

THERMAL AND MECHANICAL SPECIFICATIONS

		4AF....	8AF....	Units	Conditions
T_J	Junction operating temperature range	-65 to 175	-65 to 195	$^\circ\text{C}$	
T_{stg}	Storage temperature range	-65 to 190	-65 to 195	$^\circ\text{C}$	
R_{thJC}	Maximum internal thermal resistance, junction to case	0.80	0.60	K/W	DC operation
R_{thCS}	Maximum thermal resistance, case to heatsink	0.60	0.50	K/W	As per mounting details
wt.	Approximate weight	10 (0.36)	10 (0.36)	g (oz)	
	Outline (.... PP types only)	B-47	B-47		

MOUNTING

A $12.6 \pm 0.02\text{mm}$ (0.496 to 0.497 inch) diameter hole should be drilled in heatsink, the leading edge chamfered to 0.038mm (0.015 inch) $\times 45^\circ$. The autodiode should then be press fitted, ensuring that the sides of the autodiode are kept parallel to the sides of the hole.

4855452 INTERNATIONAL RECTIFIER

55C 04936 D



4AF, 8AF Series

T-01-19

T-01-21

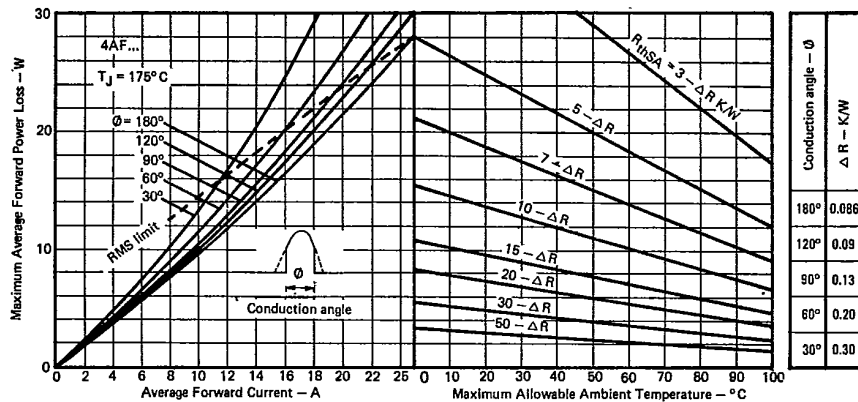
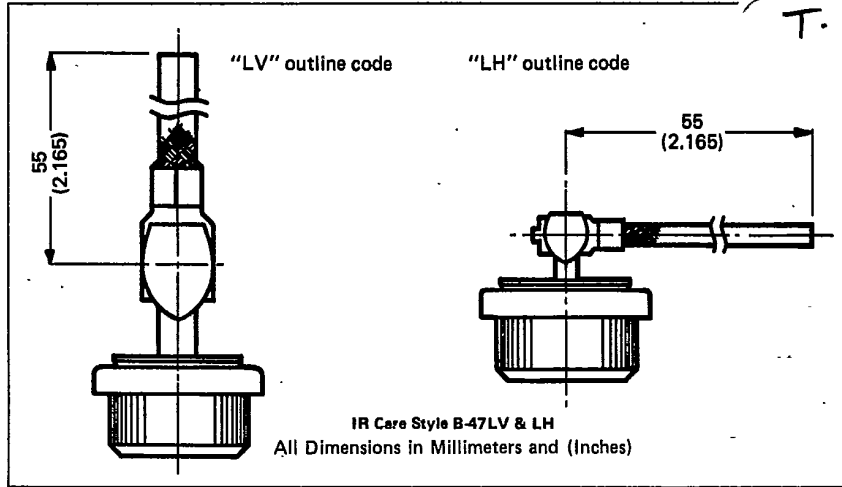

Fig. 1 - Current Rating Nomogram (Sinusoidal Waveforms 50-400 Hz), 4AF Series.

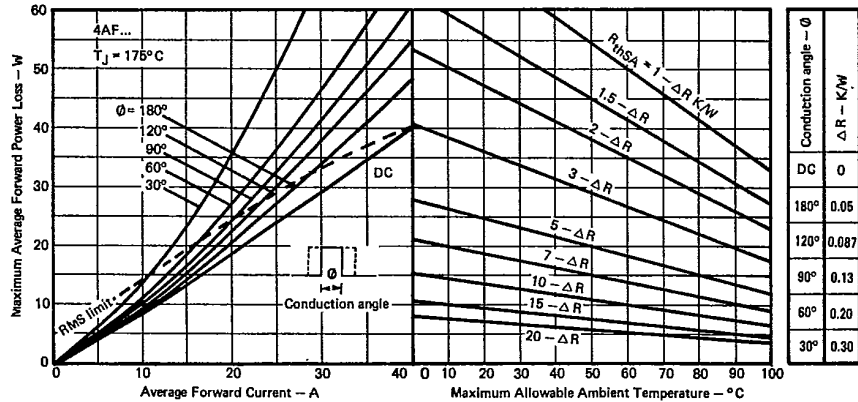

Fig. 2 - Current Rating Nomogram (Rectangular Waveforms 50-400 Hz), 4AF Series.

B

4855452 INTERNATIONAL RECTIFIER
4AF, 8AF Series

4AF Series

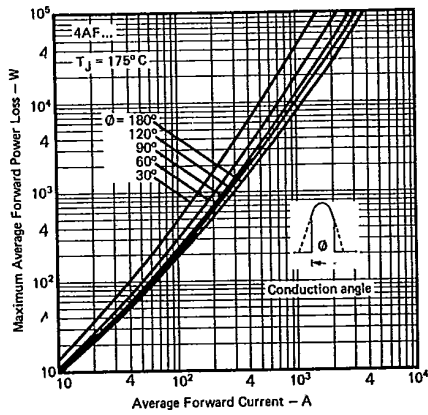

Fig. 3 - Maximum Forward Power Loss Vs. Forward Current (Sinusoidal Current Waveform), 4AF Series

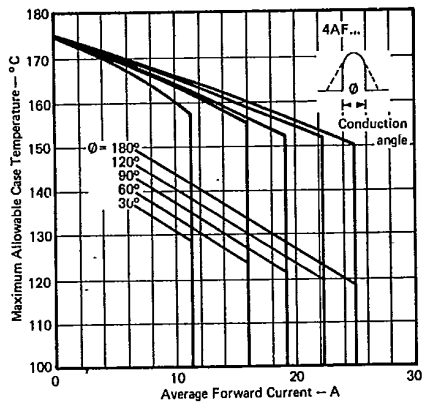

Fig. 5 - Average Forward Current Vs. Maximum Allowable Case Temperature (Sinusoidal Current Waveform), 4AF Series



55C 04937 D

INTERNATIONAL RECTIFIER **IR**

T-01-19

T-01-21

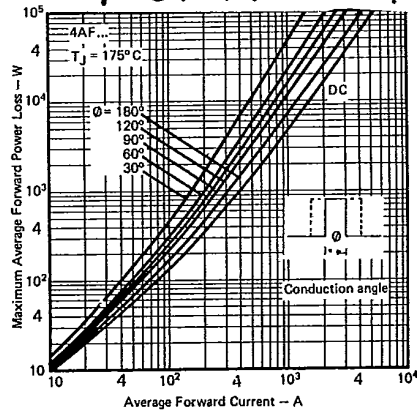

Fig. 4 - Maximum Forward Power Loss Vs. Forward Current (Rectangular Current Waveform), 4AF Series

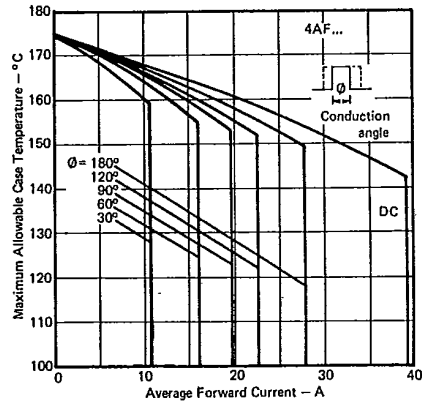

Fig. 6 - Average Forward Current Vs. Maximum Allowable Case Temperature (Rectangular Current Waveform), 4AF Series



4855452 INTERNATIONAL RECTIFIER

55C 04938 D



T-01-19

4AF, 8AF Series

T-01-21

4AF and 8AF Series

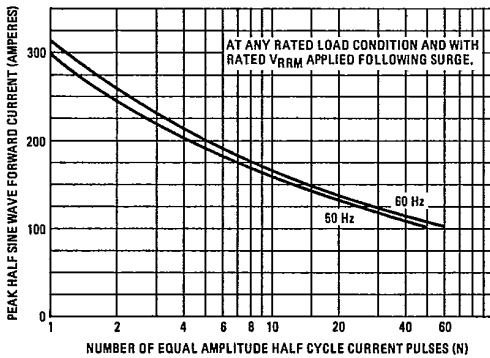

Fig. 9 - Maximum Non-Repetitive Surge Current Vs. Number of Current Pulses, 4AF Series

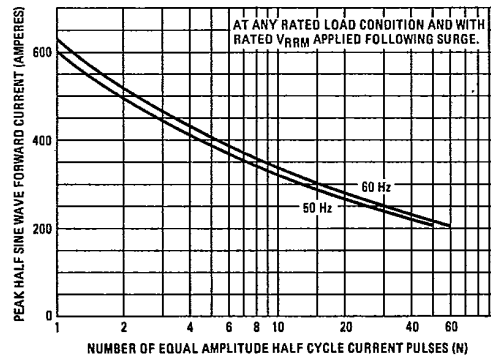

Fig. 10 - Maximum Non-Repetitive Surge Current Vs. Number of Current Pulses, 8AF Series

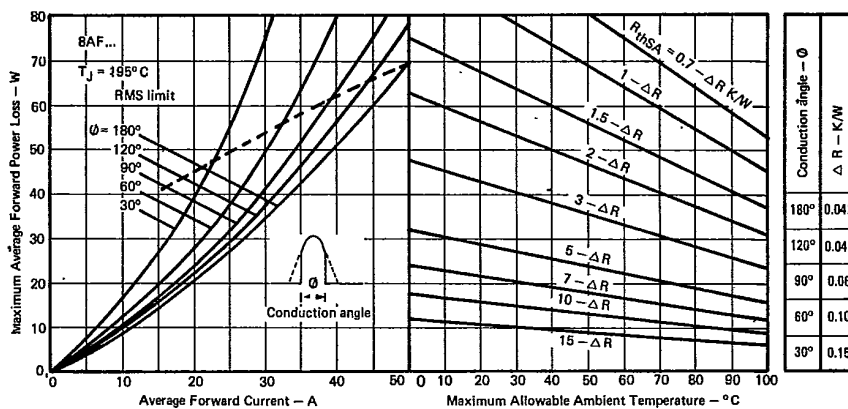

Fig. 11 - Current Rating Nomogram (Sinusoidal Waveforms 50-400 Hz), 8AF Series.

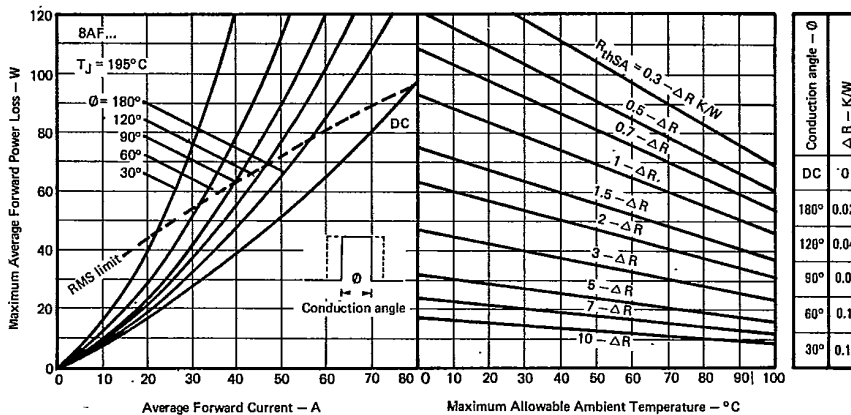

Fig. 12 - Current Rating Nomogram (Rectangular Waveforms 50-400 Hz), 8AF Series.

B

4855452 INTERNATIONAL RECTIFIER

4AF, 8AF Series

8AF Series

55C 04939 D

INTERNATIONAL RECTIFIER IOR

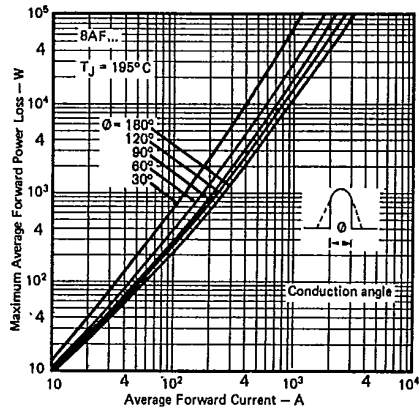

Fig. 13 — Maximum Power Loss Vs. Forward Current (Sinusoidal Current Waveform), 8AF Series

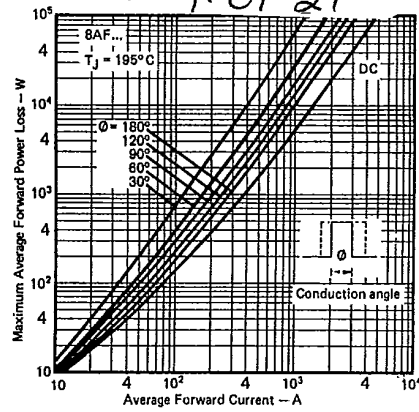

Fig. 14 — Maximum Power Loss Vs. Forward Current (Rectangular Current Waveform), 8AF Series

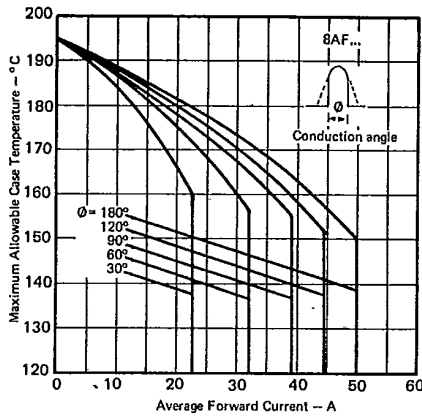

Fig. 15 — Average Forward Current Vs. Maximum Allowable Case Temperature (Sinusoidal Current Waveform), 8AF Series

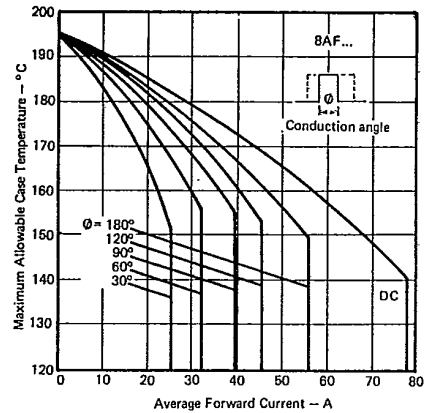

Fig. 16 — Average Forward Current Vs. Maximum Allowable Case Temperature (Rectangular Current Waveform), 8AF Series

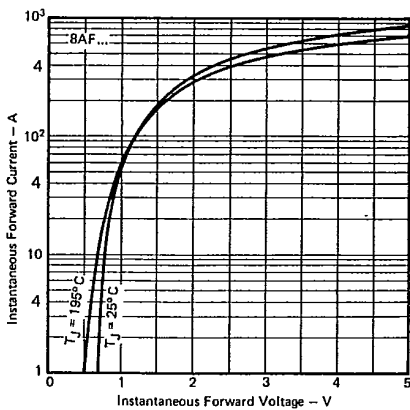

Fig. 17 — Maximum Forward Voltage Vs. Forward Current, 8AF Series

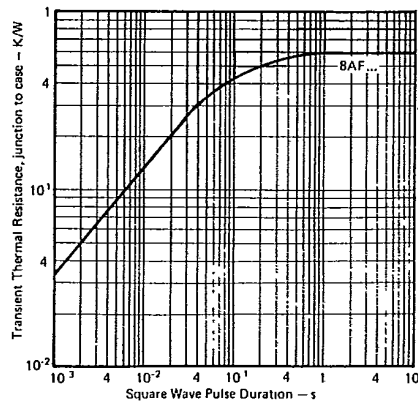

Fig. 18 — Maximum Transient Thermal Impedance, Junction-to-Case Vs. Pulse Duration, 8AF Series