

## DESCRIPTION

The 2301H uses advanced trench technology to provide excellent  $R_{DS(ON)}$ , low gate charge and operation with gate voltages as low as 2.5V. This device is suitable for use as a load switch or in PWM applications.

## GENERAL FEATURES

- | $V_{DSS}$ | $R_{DS(ON)}$<br>@-4.5V(Typ) | $R_{DS(ON)}$<br>@-10V(Typ) | $I_D$ |
|-----------|-----------------------------|----------------------------|-------|
| -30V      | 105m $\Omega$               | 65m $\Omega$               | -2 A  |

- High Power and current handing capability
- RoHS Compliant
- Surface Mount Package

## Application

- PWM applications
- Load switch
- Power management

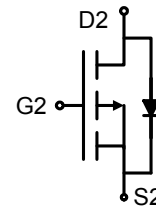

Schematic diagram

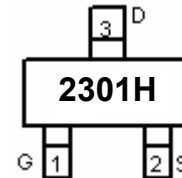

Marking and pin Assignment

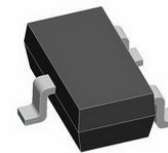

SOT-23

## Ordering Information

Part Number	Marking	Case	Packaging
2301H	2301H	SOT-23	3000pcs/Reel

## Absolute Maximum Ratings (TA=25°C unless otherwise noted)

Parameter	Symbol	Limit	Unit
Drain-Source Voltage	$V_{DS}$	-30	V
Gate-Source Voltage	$V_{GS}$	$\pm 12$	V
Drain Current-Continuous	$I_D$	-2	A
Drain Current -Pulsed (Note 1)	$I_{DM}$	-10	A
Maximum Power Dissipation	$P_D$	1	W
Operating Junction and Storage Temperature Range	$T_J, T_{STG}$	-55 To 150	$^{\circ}C$

## Thermal Characteristic

Thermal Resistance, Junction-to-Ambient (Note 2)	$R_{\theta JA}$	125	$^{\circ}C/W$
--	-----------------	-----	---------------

## Electrical Characteristics (TA=25°C unless otherwise noted)

Parameter	Symbol	Condition	Min	Typ	Max	Unit
<b>Off Characteristics</b>						
Drain-Source Breakdown Voltage	$BV_{DSS}$	$V_{GS}=0V, I_D=-250\mu A$	-20	-24	-	V
Zero Gate Voltage Drain Current	$I_{DSS}$	$V_{DS}=-20V, V_{GS}=0V$	-	-	-1	$\mu A$

Gate-Body Leakage Current	$I_{GSS}$	$V_{GS}=\pm 12V, V_{DS}=0V$	-	-	$\pm 100$	nA
<b>On Characteristics (Note 3)</b>						
Gate Threshold Voltage	$V_{GS(th)}$	$V_{DS}=V_{GS}, I_D=-250\mu A$	-0.4	-1.6	-2	V
Drain-Source On-State Resistance	$R_{DS(ON)}$	$V_{GS}=-4.5V, I_D=-2A$	-	105	130	m $\Omega$
		$V_{GS}=-10V, I_D=-3A$	-	65	125	m $\Omega$
Forward Transconductance	$g_{FS}$	$V_{DS}=-5V, I_D=-2.8A$	-	9.5	-	S
<b>Dynamic Characteristics (Note4)</b>						
Input Capacitance	$C_{iss}$	$V_{DS}=-10V, V_{GS}=0V,$ $F=1.0MHz$	-	405	-	PF
Output Capacitance	$C_{oss}$		-	75	-	PF
Reverse Transfer Capacitance	$C_{rss}$		-	55	-	PF
<b>Switching Characteristics (Note 4)</b>						
Turn-on Delay Time	$t_{d(on)}$	$V_{DD}=-10V, I_D=-1A$ $V_{GS}=-4.5V, R_{GEN}=10\Omega$	-	11	-	nS
Turn-on Rise Time	$t_r$		-	35	-	nS
Turn-Off Delay Time	$t_{d(off)}$		-	30	-	nS
Turn-Off Fall Time	$t_f$		-	10	-	nS
Total Gate Charge	$Q_g$	$V_{DS}=-10V, I_D=-3A,$ $V_{GS}=-2.5V$	-	3.3	12	nC
Gate-Source Charge	$Q_{gs}$		-	0.7	-	nC
Gate-Drain Charge	$Q_{gd}$		-	1.3	-	nC
<b>Drain-Source Diode Characteristics</b>						
Diode Forward Voltage (Note 3)	$V_{SD}$	$V_{GS}=0V, I_S=1.3A$	-	-	-1.2	V
Diode Forward Current (Note 2)	$I_S$		-	-	-1.3	A

### Notes:

1. Repetitive Rating: Pulse width limited by maximum junction temperature.
2. Surface Mounted on FR4 Board,  $t \leq 10$  sec.
3. Pulse Test: Pulse Width  $\leq 300\mu s$ , Duty Cycle  $\leq 2\%$ .
4. Guaranteed by design, not subject to production

TYPICAL ELECTRICAL AND THERMAL CHARACTERISTICS

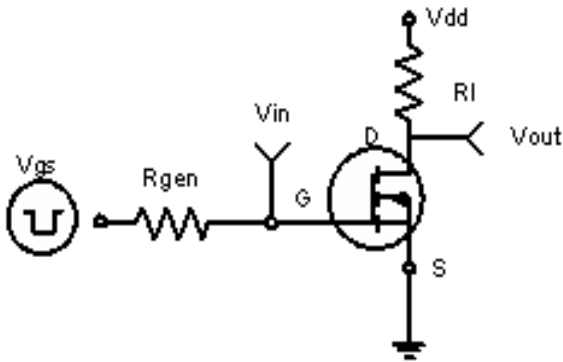

Figure 1: Switching Test Circuit

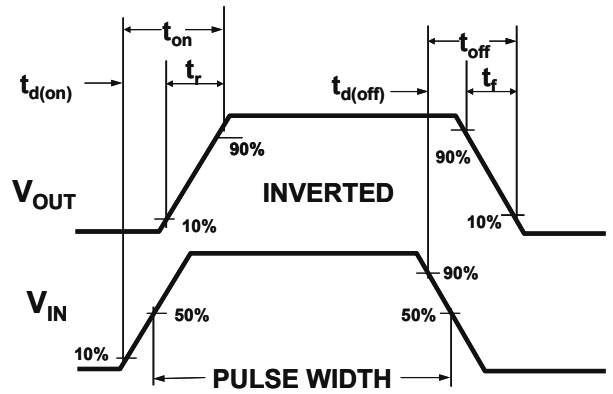

Figure 2: Switching Waveforms

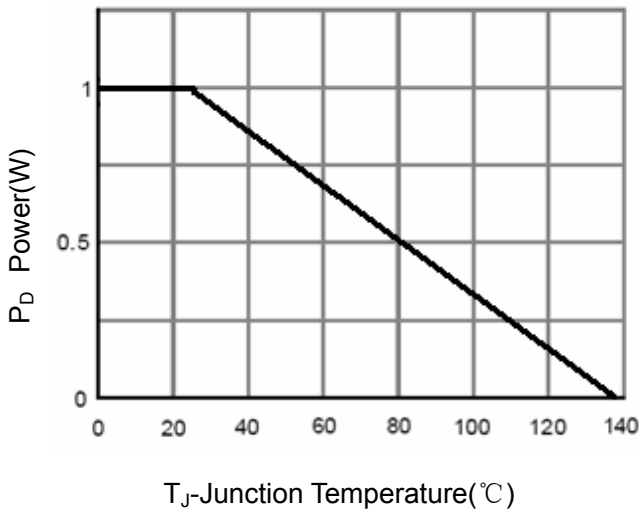

Figure 3 Power Dissipation

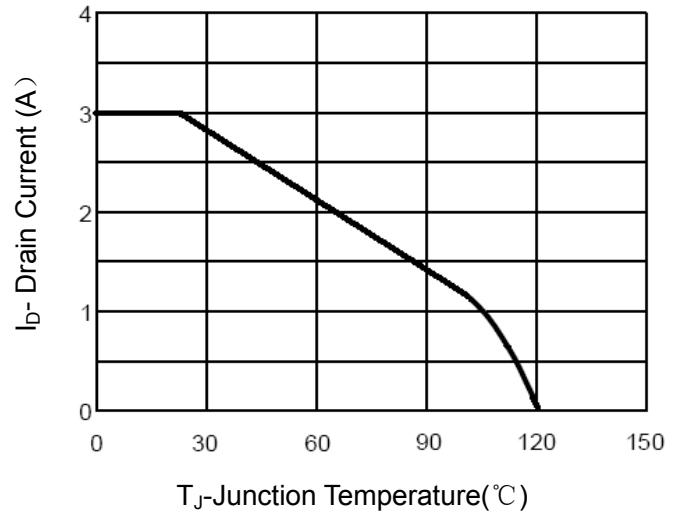

Figure 4 Drain Current

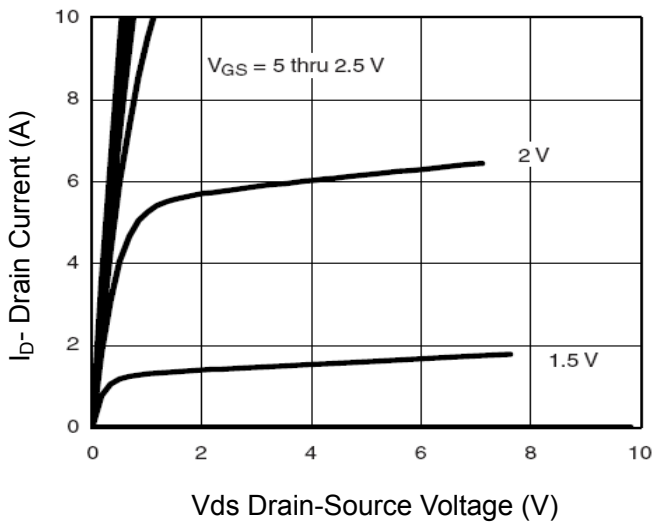

Figure 5 Output CHARACTERISTICS

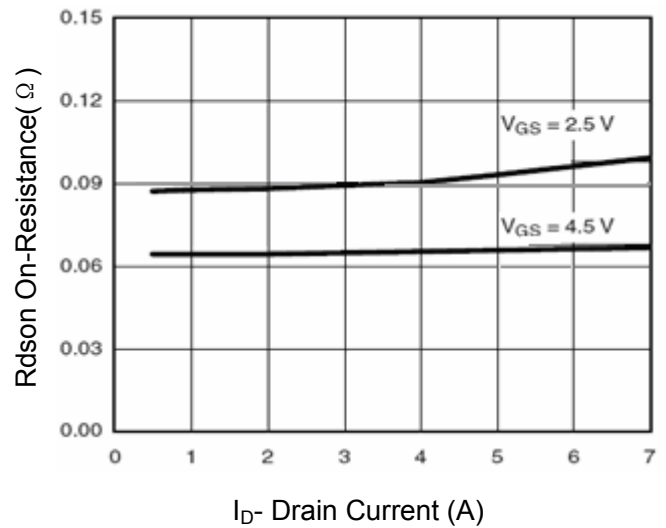
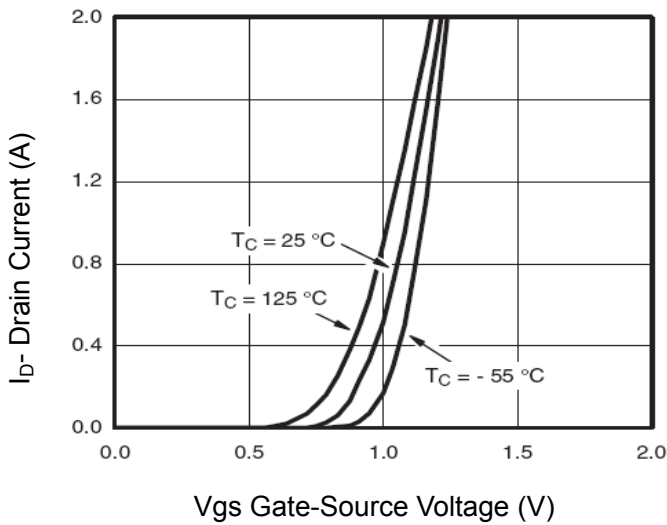
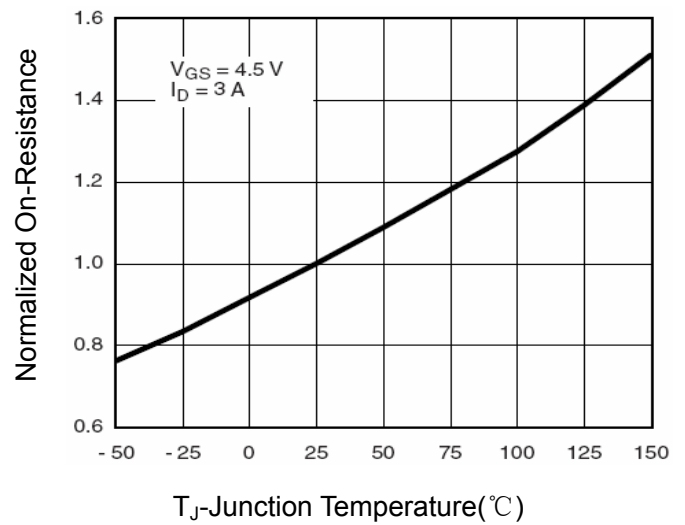

Figure 6 Drain-Source On-Resistance



Vgs Gate-Source Voltage (V)  
**Figure 7 Transfer Characteristics**



$T_J$ -Junction Temperature( $^\circ\text{C}$ )  
**Figure 8 Drain-Source On-Resistance**

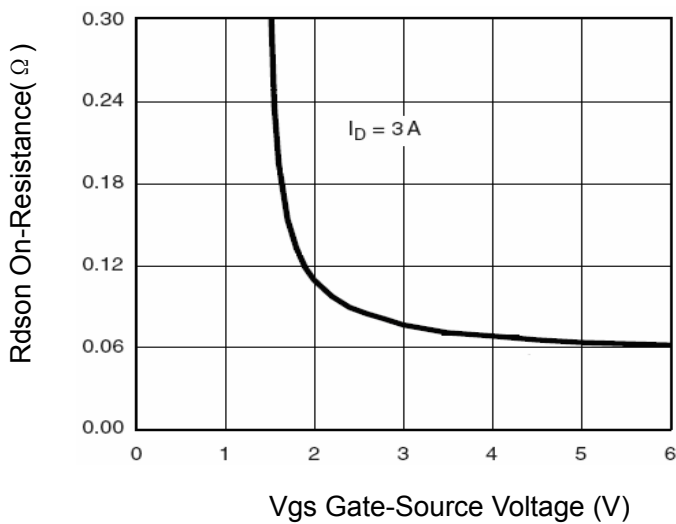

Vgs Gate-Source Voltage (V)  
**Figure 9 Rdson vs Vgs**

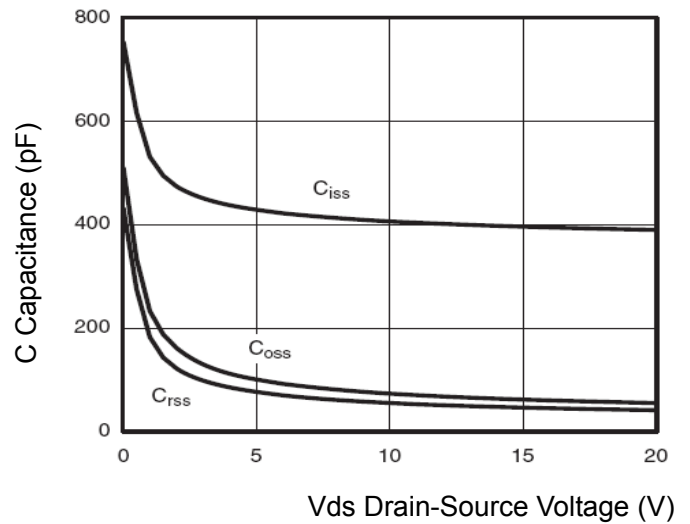

Vds Drain-Source Voltage (V)  
**Figure 10 Capacitance vs Vds**

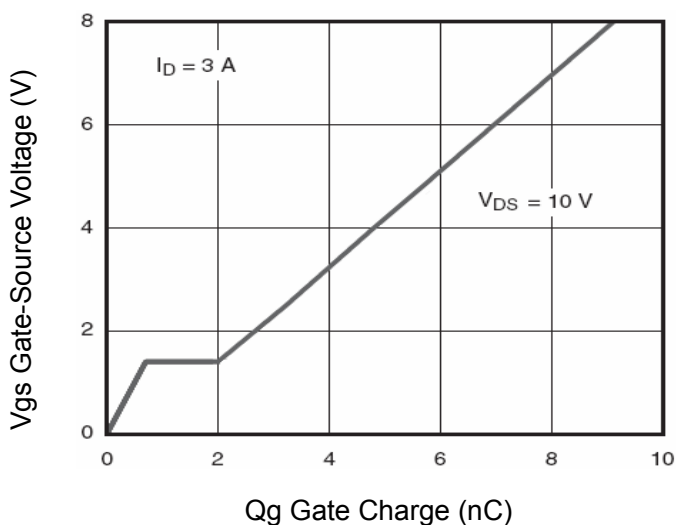

Qg Gate Charge (nC)  
**Figure 11 Gate Charge**

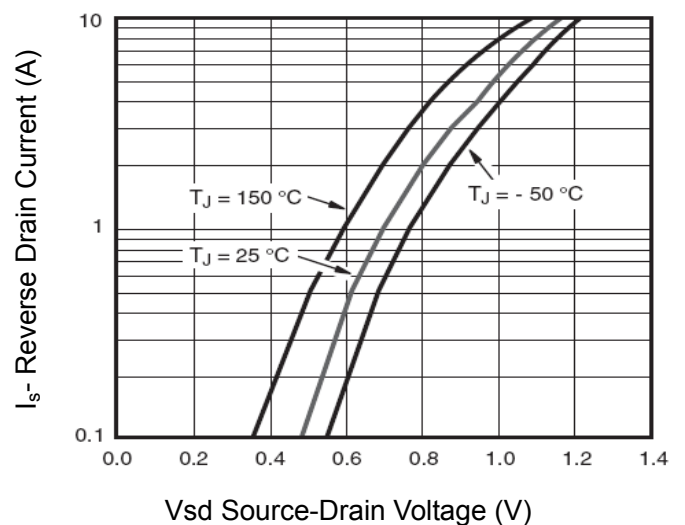

Vsd Source-Drain Voltage (V)  
**Figure 12 Source- Drain Diode Forward**

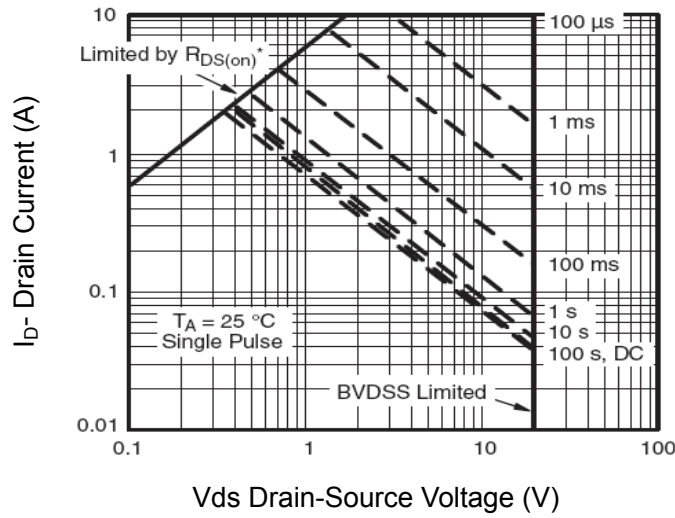

Figure 13 Safe Operation Area

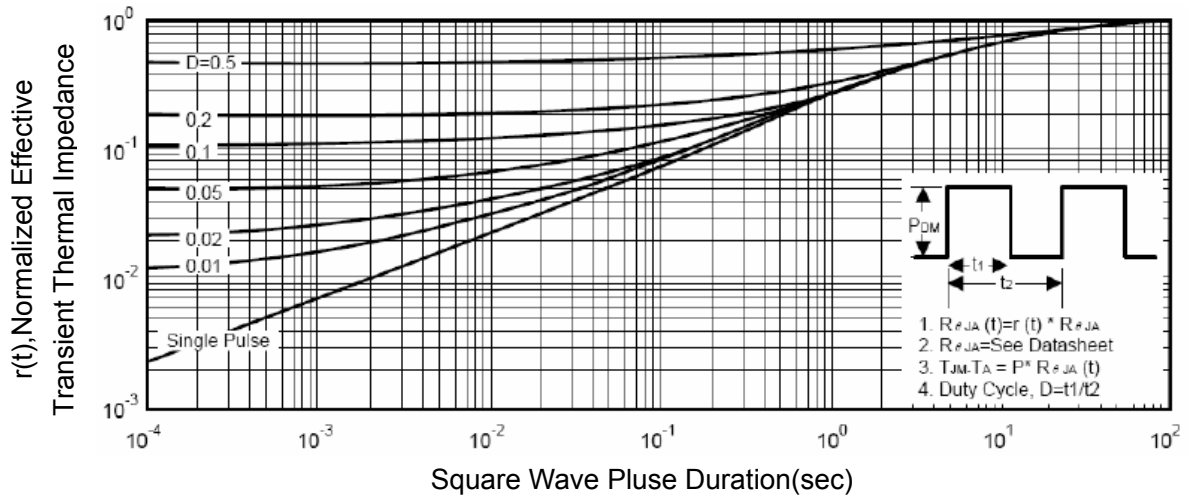
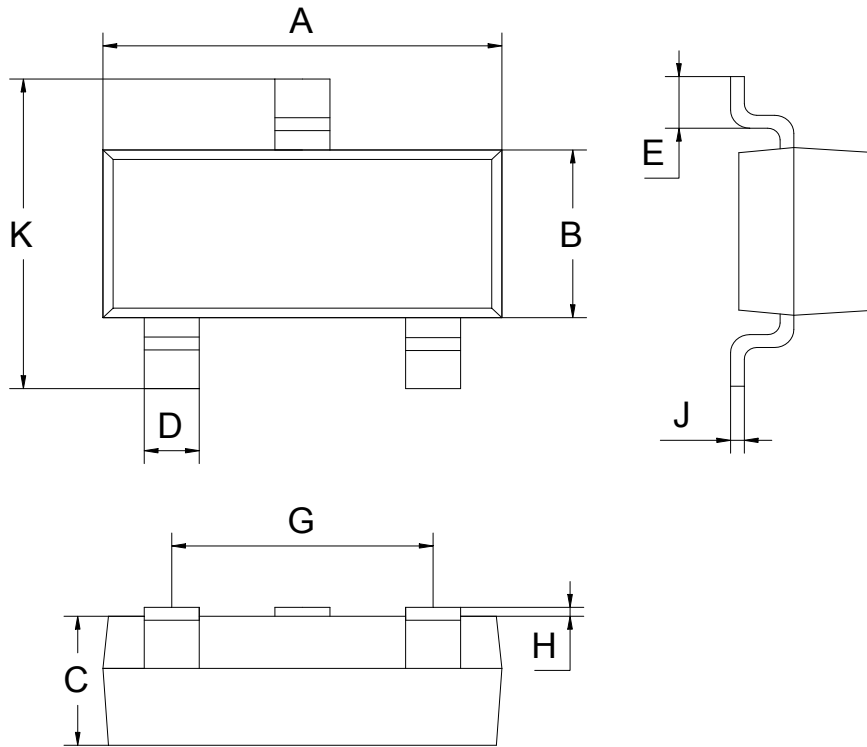

Figure 14 Normalized Maximum Transient Thermal Impedance

**SOT-23 Package information**



SOT-23			
Dim	MIN	NOM	MAX
A	2.80	2.90	3.00
B	1.20	1.30	1.40
C	0.90	1.00	1.10
D	0.39	0.40	0.45
E	0.20MIN		
G	1.90REF		
H	0.00	-	0.10
J	0.05	0.10	0.15
K	2.30	2.40	2.50
All Dimensions in mm			