

High Frequency Ceramic Solutions

Ultra Miniature 2.45GHz Impedance Matched FCC / ETSI Compliant Low Pass Filter for Nordic's Chipset nRF52832-QFAA, nRF52832-QFAB, nRF52810-QFAA, nRF52810-QCAA

P/N 2450FM07A0029

Detail Specification: 11/6/2017

Page 1 of 4

General Specifications

Part Number	2450FM07A0029
Frequency (MHz)	2400 - 2500
Insertion loss (dB)	0.8 max.
Return Loss (dB)	10 min.
Input Impedance (Terminal Towards Chipset)	Impedance matched to nRF52832-QFAA, nRF52832-QFAB, nRF52810-QFAA, nRF52810-QCAA
Output Impedance	50Ω
Power Capacity	2W max. (CW)
Attenuation (dB)	
4800~5000MHz	23 typ. @25°C 20 min.
7200~7500MHz	12 typ. @25°C 18 min.

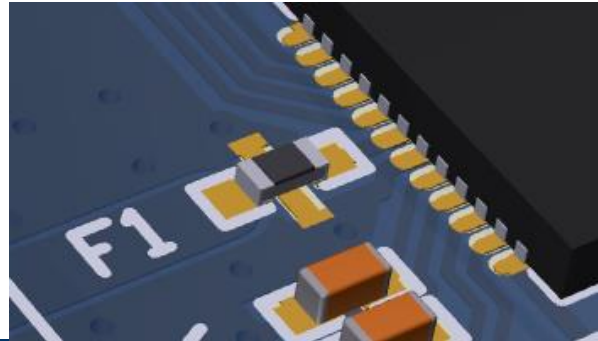

Reel Quantity	10,000 pcs
Operating Temperature	-40 to +85°C
Recommended Storage Conditions for unused T&R product	+5 to +35°C, Humidity: 45-75%RH, 18 mo. Max.

You can download measured s-parameters of this component at: www.johansontechnology.com/nordic

Part Number Explanation

P/N Suffix	Packaging Style	Bulk	Suffix = S	e.g. 2450FM07A0029S
		T & R	Suffix = T	e.g. 2450FM07A0029T
	Termination Style	100% Tin	Suffix = None	e.g. 2450FM07A0029(T or S)

For the Full App Note and Layout Files, go to: www.johansontechnology.com/nordic

Mechanical Dimensions

	In	mm
L	0.039 ± 0.002	1.00 ± 0.05
W	0.020 ± 0.002	0.50 ± 0.05
T	0.016 max.	0.40 max.
a	0.007 ± 0.004	0.18 ± 0.10
b	0.010 ± 0.004	0.25 ± 0.10

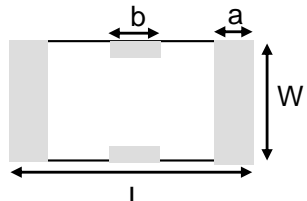
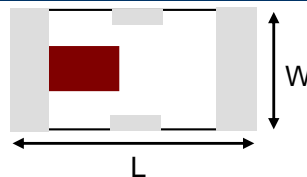
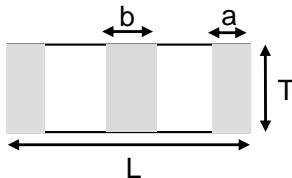

Terminal Configuration

No.	Function
1	IN (To RFIC)
2	GND
3	OUT (To Antenna)
4	GND

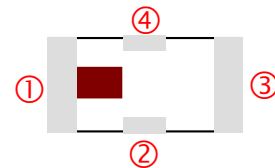

Johanson Technology, Inc. reserves the right to make design changes without notice.

All sales are subject to Johanson Technology, Inc. terms and conditions.



Ver. 1.3

www.johansontechnology.com

4001 Calle Tecate • Camarillo, CA 93012, USA • TEL +1.805.389.1166

2017 Johanson Technology, Inc. All Rights Reserved

High Frequency Ceramic Solutions

Ultra Miniature 2.45GHz Impedance Matched FCC / ETSI Compliant Low Pass Filter for
Nordic's Chipset nRF52832-QFAA, nRF52832-QFAB, nRF52810-QFAA, nRF52810-QCAA



P/N 2450FM07A0029

Detail Specification: 11/6/2017

Page 2 of 4

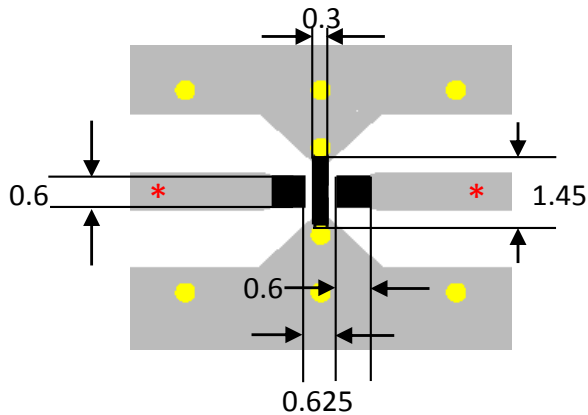
Mounting Pad Dimensions



-  Solder Resist
-  Land
-  Through-hole (ϕ 0.35)

*Line width should be designed to match 50 Ω characteristic impedance, depending on PCB material and thickness.

Do you need the layout files of the above? Go to: www.johansontechnology.com/nordic or send us a message to review your layout at: www.johansontechnology.com/ask-a-question

Measurement Schematic

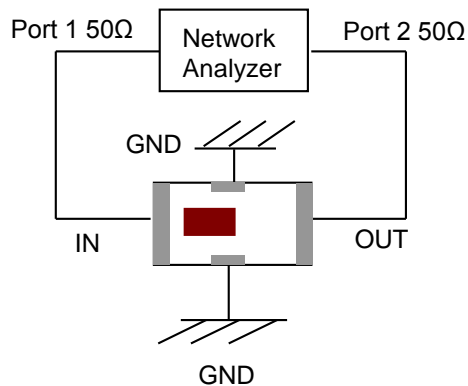

Port 1: Filter IN (marking side)
Port 2: Filter OUT

Johanson Technology, Inc. reserves the right to make design changes without notice.
All sales are subject to Johanson Technology, Inc. terms and conditions.



Ver. 1.3

www.johansontechnology.com

4001 Calle Tecate • Camarillo, CA 93012, USA • TEL +1.805.389.1166

2017 Johanson Technology, Inc. All Rights Reserved

High Frequency Ceramic Solutions

Ultra Miniature 2.45GHz Impedance Matched FCC / ETSI Compliant Low Pass Filter for Nordic's Chipset nRF52832-QFAA, nRF52832-QFAB, nRF52810-QFAA, nRF52810-QCAA

P/N 2450FM07A0029

Detail Specification: 11/6/2017

Page 3 of 4

Typical Electrical Characteristics (T=25°C)

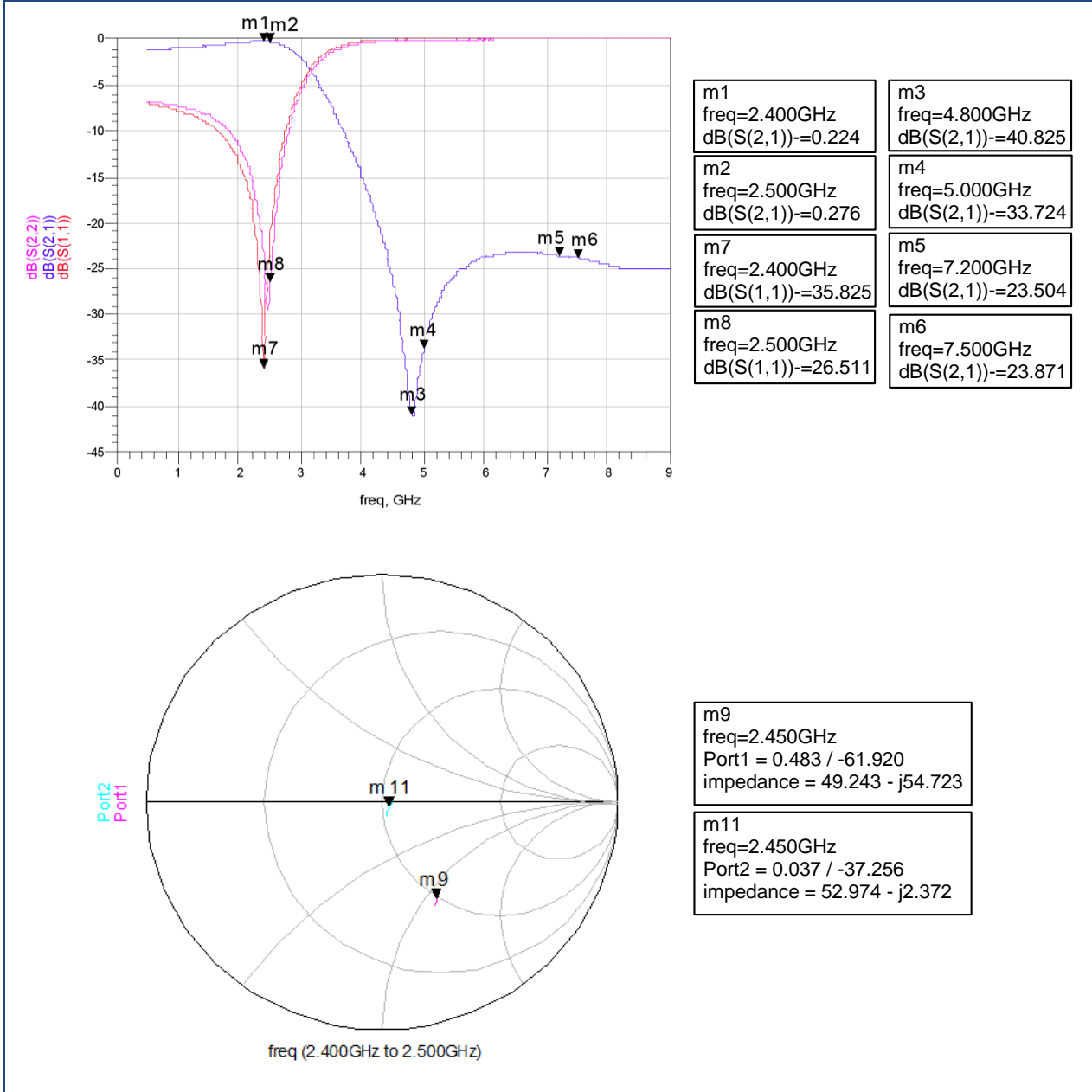

Johanson Technology, Inc. reserves the right to make design changes without notice.
All sales are subject to Johanson Technology, Inc. terms and conditions.



www.johansontechnology.com

4001 Calle Tecate • Camarillo, CA 93012, USA • TEL +1.805.389.1166

Ver. 1.3 2017 Johanson Technology, Inc. All Rights Reserved

High Frequency Ceramic Solutions

Ultra Miniature 2.45GHz Impedance Matched FCC / ETSI Compliant Low Pass Filter for
Nordic's Chipset nRF52832-QFAA, nRF52832-QFAB, nRF52810-QFAA, nRF52810-QCAA

P/N 2450FM07A0029

Detail Specification: 11/6/2017

Page 4 of 4

Application Notes, Layout Files, and more

www.johansontechnology.com/nordic

Packaging information

www.johansontechnology.com/tape-reel-packaging

Soldering Information

www.johansontechnology.com/ipcsoldering-profile

MSL Info

www.johansontechnology.com/msl-rating

Recommended Storage Condition and Max Shelf Life

www.johansontechnology.com/recommended-storage-conditions

RoHS Compliance

www.johansontechnology.com/technical-notes/rohs-compliance

Antenna layout and tuning techniques

www.johansontechnology.com/tuning

Antenna layout review, tuning, and characterization services

www.johansontechnology.com/ipc-antenna-services

Johanson uses 6/6 RoHS Green Low-Temperature-Co-fired-Ceramic (LTCC) integrated passive technology in a 4-pin (Sn plated) monolithic structure. This component is 100% RF Tested, making it a more reliable system, impedance controlled environment, consistent-guaranteed RF performance in a very small RF front end-solution compared to the L/C discrete solution.



Johanson Technology, Inc. reserves the right to make design changes without notice.
All sales are subject to Johanson Technology, Inc. terms and conditions.



Ver. 1.3

www.johansontechnology.com

4001 Calle Tecate • Camarillo, CA 93012, USA • TEL +1.805.389.1166

2017 Johanson Technology, Inc. All Rights Reserved