

# TOSHIBA

COLOUR TELEVISION

# 2806XH

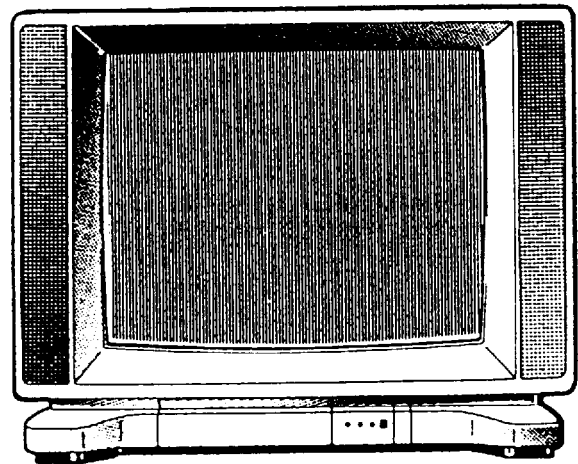

## SPECIFICATIONS

<b>Input Power Rating:</b>	143 watts (nominal), AC 110~245 volts, 50 / 60 Hz
<b>Aerial Input Impedance:</b>	75 ohm unbalanced type VHF and UHF
<b>Receiving Channels:</b>	<p><b>PAL B / G, SECAM B / G system</b></p> <p>VHF channels ..... channels 2 to 12</p> <p>UHF channels ..... channels 21 to 69</p> <p><b>PAL D / K, SECAM D / K, K1 system</b></p> <p>VHF channels ..... channels 1 to 12</p> <p>UHF channels ..... channels 21 to 69</p> <p><b>PAL I system</b></p> <p>UHF channels ..... channels 21 to 69</p> <p><b>NTSC standard (US M, JAPAN M) system</b></p> <p>VHF channels ..... channels 2 to 13 / 1 to 12</p> <p>UHF channels ..... channels 14 to 78 / 13 to 62</p> <p><b>CATV BAND</b></p> <p>PAL B/G, SECAM B/G ..... <input type="checkbox"/> X ~ Z (S1 ~ S3)</p> <p><input type="checkbox"/> M1 ~ M10 (S1 ~ S10)</p> <p><input type="checkbox"/> U1 ~ U10 (S11 ~ S20)</p> <p><input type="checkbox"/> A-6 ~ A-1</p> <p><input type="checkbox"/> A ~ I</p> <p><input type="checkbox"/> J ~ W</p> <p>NTSC-M ..... <input type="checkbox"/></p>
<b>Intermediate Frequencies:</b>	<p>Picture I-F carrier frequency ..... 38.0 MHz</p> <p>Sound I-F carrier frequency ..... 33.5 / 32.5 / 32.0 / 31.5 MHz</p>
<b>Picture Tube:</b>	28 inches, A66KHP96X (66 cm measured on diagonal of viewable picture area), 110' Deflection
<b>Sound Output:</b>	Main: 7.0 watts x 2
<b>Speakers:</b>	Main: 70 mm x 130 mm 2 pcs
<b>Dimensions:</b>	<p>Height ..... 610 mm</p> <p>Width ..... 770 mm</p> <p>Depth ..... 529 mm</p>
<b>Weight:</b>	37.5 kg
<b>Features:</b>	Clearness tube, VIDEO and AUDIO input / output terminals, S-VIDEO input terminals, Surround audio system, Off timer, Remote Control

Specifications are subject to change without notice.

## SAFETY INSTRUCTIONS

**WARNING:** BEFORE SERVICING THIS CHASSIS, READ THE "X-RAY RADIATION PRECAUTION", "SAFETY PRECAUTION" AND "PRODUCT SAFETY NOTICE" DESCRIBED BELOW.

### X-RAY RADIATION PRECAUTION

1. Excessive high voltage can produce potentially hazardous X-RAY RADIATION. To avoid such hazards, the high voltage must not be above the specified limit. The nominal value of the high voltage of this receiver is 30.4kV at zero beam current (minimum brightness) under 110 ~ 245V AC power source. The high voltage must not, under any circumstances, exceed 32kV. Each time a receiver requires servicing, the high voltage should be checked following the HIGH VOLTAGE CHECK procedure in this manual. It is recommended the reading of the high voltage be recorded as a part of the service record. It is important to use an accurate and reliable high voltage meter.
2. The only source of X-RAY RADIATION in this TV receiver is the picture tube. For continued X-RAY RADIATION protection, the replacement tube must be exactly the same type tube as specified in the parts list.
3. Some parts in this receiver have special safety-related characteristics for X-RAY RADIATION protection. For continued safety, parts replacement should be undertaken only after referring to the PRODUCT SAFETY NOTICE below.

### SAFETY PRECAUTION

1. Potentials as high as 27kV are present when this receiver is operating. Operation of the receiver outside the cabinet or with back board removed involves a shock hazard from the receiver.
  1. Servicing should not be attempted by anyone who is not thoroughly familiar with the precautions necessary when working on high-voltage equipment.
  2. Always discharge the picture tube anode to the receiver chassis to keep off the shock hazard before removing the anode cap.
  3. Perfectly discharge the high potential of the picture tube before handling the tube. The picture tube is highly evacuated and if broken, glass fragments will be violently expelled.
2. If any Fuse in this TV receiver is blown, replace it with the Fuse specified in the chassis parts list.
3. When replacing parts or circuit boards, wind the lead wires around terminals before soldering.
4. When replacing a high wattage resistor (oxide metal film resistor) in circuit board, keep the resistor 10mm away from circuit board.
5. Keep wires away from high voltage or high temperature components.
6. This receiver can be operated under AC 110 ~ 245 volts, 50/60Hz. NEVER connect to DC supply or any other power.

### PRODUCT SAFETY NOTICE

Many electrical and mechanical parts in this chassis have special safety-related characteristics. These characteristics are often passed unnoticed by a visual inspection and the X-RAY RADIATION protection afforded by them cannot necessarily be obtained by using replacement components rated for higher voltage, wattage, etc. Replacement parts which have these special safety characteristics are identified in this manual and its supplements, electrical components having such features are identified by the international hazard symbols on the schematic diagram and the parts list.

Before replacing any of these components, read the parts list in this manual carefully. The use of substitute replacement parts which do not have the same safety characteristics as specified in the parts list may create X-RAY RADIATION.

# LOCATION OF CONTROLS

## FRONT

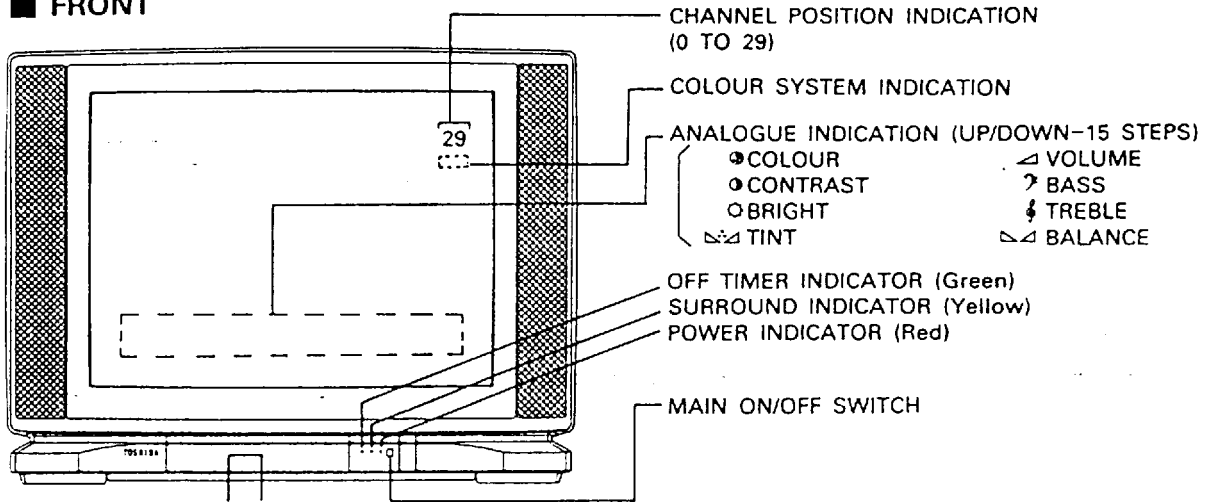

PUSH HERE TO OPEN THE DOOR

## BACK

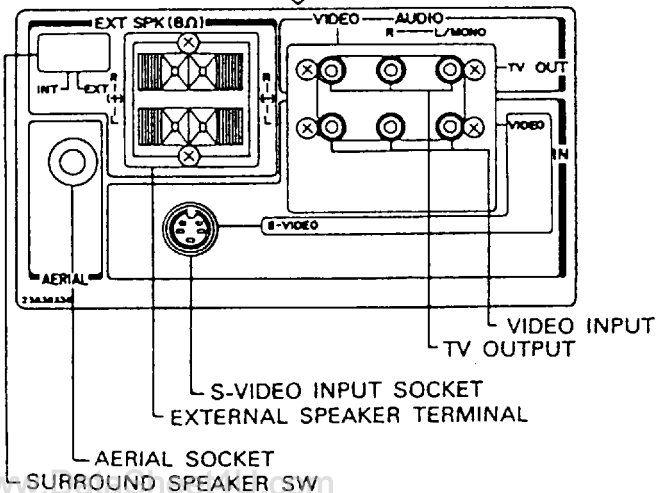
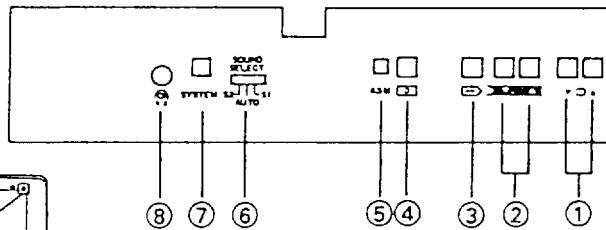
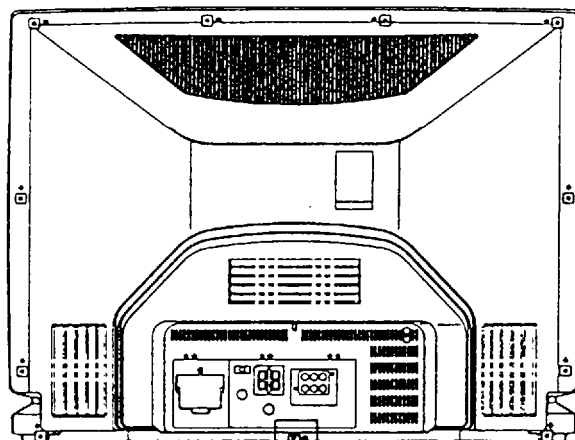

## REMOTE CONTROL HAND UNIT

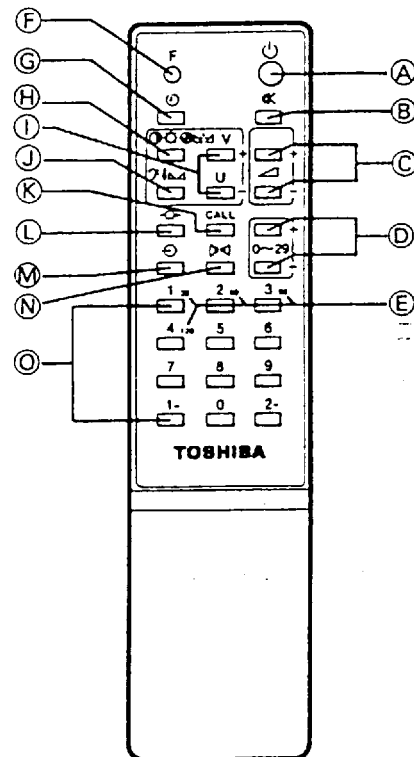

# TV PROGRAM RECEPTION

## ■ WHEN USING REMOTE CONTROL HAND UNIT

### ■ SET UP

**Press the switch:** Indicator lamp will be lit and the TV set is ready for viewing.

**To turn off the TV:** Press the button again.

- Once the MAIN ON/OFF switch is turned on, you can remote-control the TV set.
- If the TV turned off by pressing the MAIN ON/OFF switch on the TV set, it will be turned "on" by pressing the MAIN ON/OFF switch only.

- 1** The TV set is turned on and off by pressing the ON/OFF button **A**.  
Also it is turned "on" directly by pressing a POSITION button **D**.

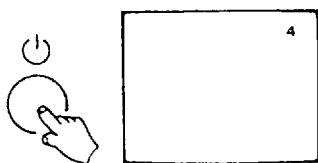

**Press the button:** The TV set will be turned "on" and the picture of previously viewed the channel is seen.

**To turn off the TV:** Press the button again.

- 2** Channel is tuned by pressing the CHANNEL buttons **D**.

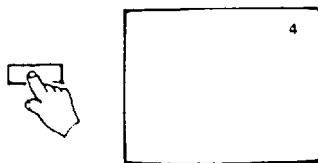

The picture will be changed over, and you will have the position No. displayed on the screen for a few seconds.

- When position No. is in 2 digits (10 to 29), stay pressing 1- or 2- buttons and press the button of the last number.

- Channel change can be performed by CHANNEL buttons **D** as well.

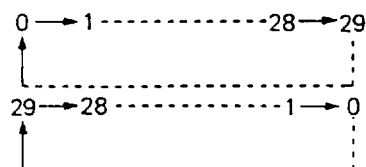
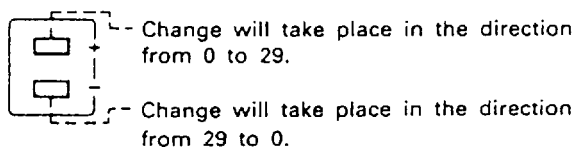

- 3** Sound volume is adjusted by VOLUME buttons **C**.

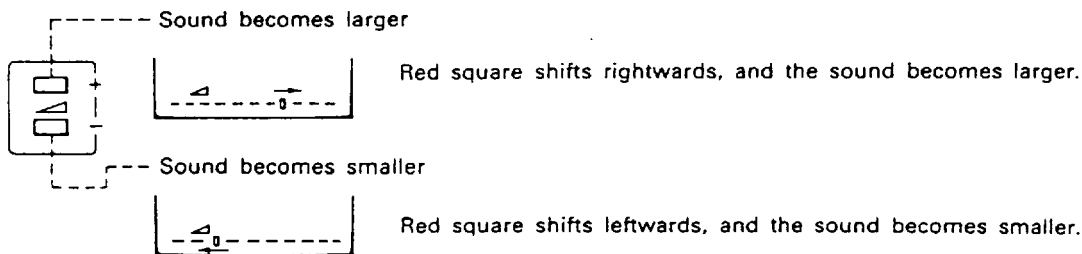

### Notes:

- In operating the Remote Control Hand Unit, direct it toward the receiving section of the receiver.
- Even if power is turned off by pressing the POWER button on the Remote Control Hand Unit, a trace of electric current stays flowing in the TV set. If television is not viewed for a long time, turn off the MAIN ON/OFF switch. When going out, take out the power plug from the wall outlet.

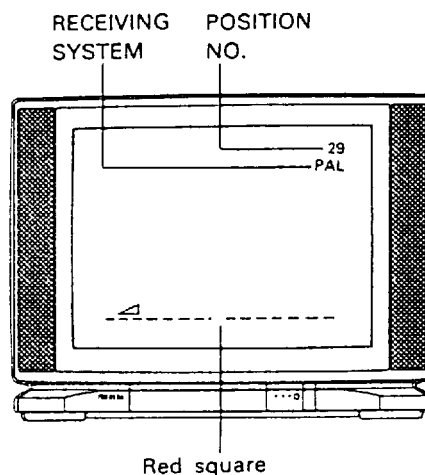

## PICTURE CONTROL

(CONTRAST, BRIGHTNESS, COLOUR, TINT)

To adjust picture for your preference, first select a function by the PICTURE button (H), then adjust the level by the LEVEL buttons (I).

### FUNCTION SELECT

Press the PICTURE button (H) to select a function to be adjusted among CONTRAST, BRIGHTNESS, COLOUR, TINT. One pressing shifts the function to the next one as shown below.

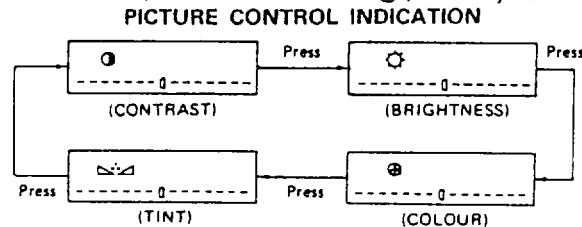

### LEVEL ADJUSTMENT

- After the function selection above, immediately (within 4 seconds) press the ▲ (+) or ▼ (-) button of LEVEL buttons (I). Press continuously to shift the level to the next step, and release the button at your preferred picture. The LEVEL buttons are effective only during the selected function is displayed.
- Above display will disappear if no additional pressing of CONTROL or LEVEL (▲ / ▼) button is done within 4 seconds.
- The last adjusted value will be stored into memory when LEVEL (▲ / ▼) button is released.
- The RESET (→□←) button (L) resets the level corresponding to picture control function (CONTRAST, BRIGHTNESS, COLOUR and TINT) to the value which is previously programmed by customers. In order to program the reset value, press the MEMORY (◇) button (4) after adjusting each function.
- Adjustment steps and indication:  
Each function can be adjusted with 64 steps and its approx. adjusted value is displayed with 15 steps.

	FUNCTION	CONTROL DOWN ▼ Button (The red square moves left)	CONTROL UP ▲ Button (The red square moves right)
PICTURE CONTROL Button	CONTRAST	Weak	Strong
	BRIGHTNESS	Dark	Light
	COLOUR	Pale	Deep
	TINT	Purplish	Greenish

## SOUND CONTROL

(BASS, TREBLE, BALANCE)

To adjust sound for your preference, first select a function by the SOUND button (J), then adjust the level by the LEVEL buttons (I).

### FUNCTION SELECT

Press the SOUND button (J) to select a function to be adjusted among BASS, TREBLE and BALANCE. One pressing shifts the function to the next one as shown below.

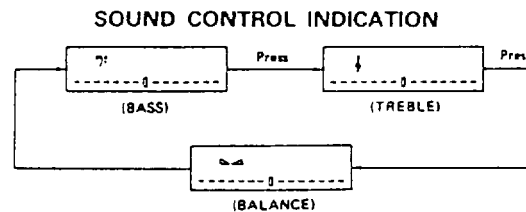

### LEVEL ADJUSTMENT

- After the function selection above, immediately (within 4 seconds) press the ▲ (+) or ▼ (-) button of LEVEL buttons (I). Press continuously to shift the level to the next step, and release the button at your preferred sound. The LEVEL buttons are effective only during the selected function is displayed.
- Above display will disappear if no additional pressing of CONTROL or LEVEL (▲ / ▼) button is done within 4 seconds.
- The last adjusted value will be stored into memory when LEVEL (▲ / ▼) button is released.
- Adjustment steps and indication:  
Each function can be adjusted with 64 steps and its adjusted approx. value is displayed with 15 steps.

	FUNCTION	CONTROL DOWN ▼ Button (The red square moves left)	CONTROL UP ▲ Button (The red square moves right)
SOUND CONTROL Button	BASS	Low tones are weakened	Low tones are enhanced
	TREBLE	High tones are weakened	High tones are enhanced
	BALANCE	Lowers sound from the right speaker	Lowers sound from the left speaker

## ■ CALL SWITCH button

- The display and erasure will alternate each time the CALL button (K) is pressed.

### Channel number

- Is displayed in position Nos. from 0 to 29. The receiving system at the time is also displayed.

### Video

- In video mode, display is made either by 1. The receiving system at the time is also displayed.

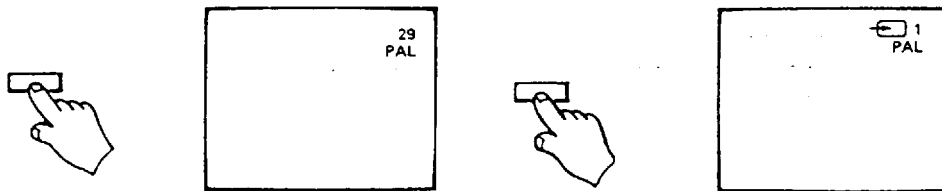

## ■ MUTE

- The sound mute and restoration will alternate each time the MUTE button (B) is pressed.
- This feature is useful:

During phone call.



Be silent!

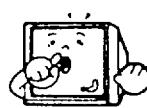

When receiving a visitor.



- The muting will be cancelled by pressing either POWER, CHANNEL, VOLUME, VIDEO, SURROUND LEVEL, SEARCH, ASM or SYSTEM button.

## ■ TV/VIDEO SW

- Each time the video button (M) is pressed, selection will be changed over in sequence.
- The VIDEO button on the TV set operates in the same way.

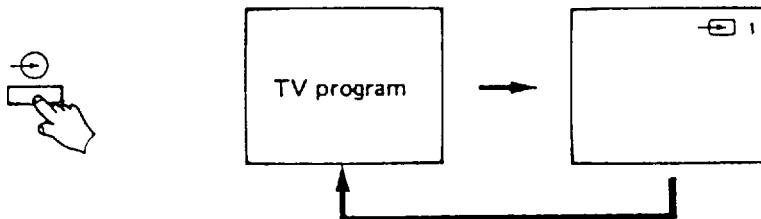

- If you press the CHANNEL button (0 to 29), the channel is changed over to the selected one.

## ■ SIMPLIFIED SURROUND

Press the SURROUND button (N).

The effect of spreading sound is turned on by pressing this button.

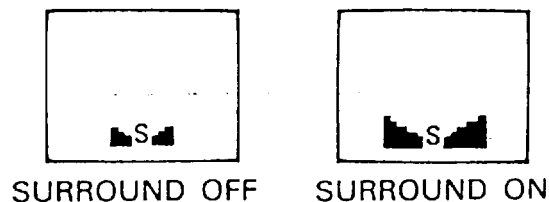

## ■ OFF TIMER

This feature allows you to set the TV to turn off automatically after elapse of a time which you can reserve in 4 patterns: after 30, 60, 90 and 120 minutes.

Example Set to OFF 60

1 Press the OFF TIMER button (G).

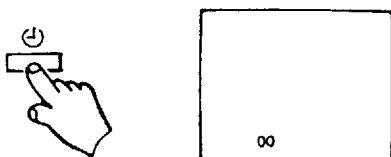

2 Press the TIME SELECT button (E).

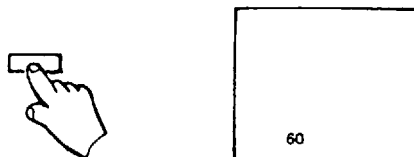

**NOTE:** If the power is turned off, the setting will be cancelled.

### To change the time reservation.

Press the OFF TIMER button (G), and then press the TIME SELECT button (E) to set the time to which the change has been made.

### To cancel the reservation.

Press the OFF TIMER button (G), and then press the RESET button (L).

### If you want to know the time remaining.

Press the OFF TIMER button (G) to have the remaining time displayed on the screen.

## ■ V/U SEARCH

For example: The channel 3 on the position 3

- (1) Select the position 3 with the DIRECT POSITION buttons (C) on the remote hand unit or the CHANNEL UP/DOWN buttons (1) on the TV.
- (2) Press together the "F" (F) and "V" buttons (1) on the remote hand unit.  
Search begins on the channel 3.
- (3) Press repeatedly the "F" (F) and "V" buttons (1) until the desired position 3 is received on the screen.
- (4) When you desire to memorize the UHF channels, in the above procedure, press the "F" (F) and "U" buttons (1) together.
- (5) During the search operation, ">>>" is indicated with flickering in 0.2 seconds interval.  
When the search reaches to the lowest frequency of TV VHF/UHF band, the search stops and ">>>" will be indicated continuously (not flickering).  
In this case, press the "F" (F) and "V" buttons (1) or the "F" (F) and "U" buttons (1) again to restart the search operation.

# TV PROGRAM RECEPTION

## ■ CONTROLLING THE TV SET PROPER

- In case the Remote Control Hand Unit is not near at hand, or batteries have been used up, you can control the TV on the receiver proper.

### 1 The TV set is turned on and off by operating the MAIN ON/OFF switch.

Press it: The TV set is turned on.  
To turn off: Press the switch again.

Note: When the TV set is not turned on with the MAIN ON/OFF switch pressed, press the VOLUME buttons ② or the CHANNEL buttons ①.

### 2 Channel is tuned by the CHANNEL buttons (behind the door)

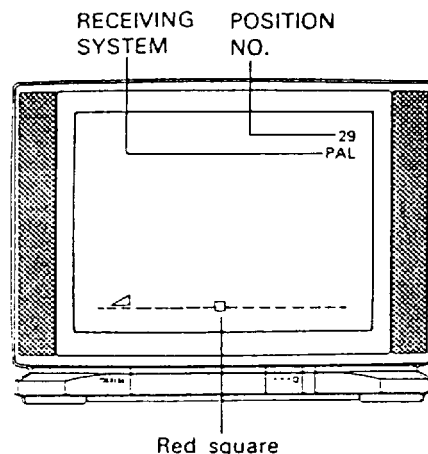
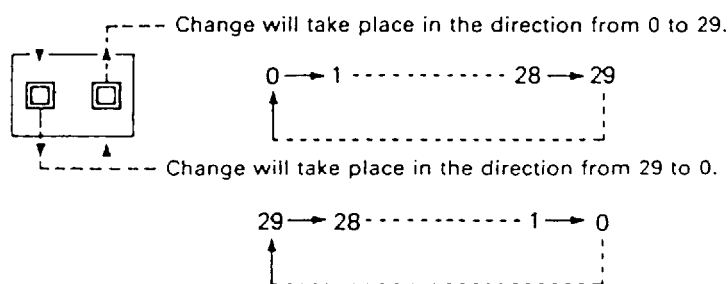

### 3 Sound volume is adjusted by VOLUME buttons (behind the door)

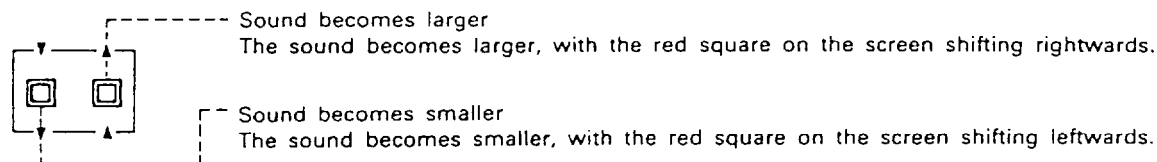

## ■ FINE TUNING

If the receiving condition in your area is poor, the detuning adjustment may be recommended for better viewing with the FINE TUNING button.

Note: In the fine tuning mode, receiving picture may deviate slightly, because the automatic frequency control is deactivated.  
At that time, readjust the fine tuning to correct the deviation.

- (1) Press the MFT (Manual Fine Tuning) button ③ on the TV.  
" 000 " is indicated under the position number display.

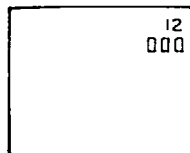

- (2) Press the VOLUME UP/DOWN buttons ② ③ to adjust the picture for better one.
- (3) The fine tuning mode is released with the POSITION button, TV/VIDEO button or POWER ON/OFF button pressed.



## ■ TO MEMORIZE ALL CHANNELS IN SEQUENCE AUTOMATICALLY

### ASM: Free position Auto Search Memory

For example, to memorize channels from the position 1 automatically:

1. Select the position 1 with the DIRECT POSITION buttons ⑩ on remote hand unit or the CHANNEL UP/DOWN buttons ① ② on TV receiver.
2. Press once the AUTO SEARCH MEMORY button ⑤ on the TV, and all active channels (stations) in your area are automatically memorized on the positions from smaller number to larger one in sequence.

During the operation of AUTO SEARCH MEMORY, ">>>" are indicated with flickering in 0.2 seconds interval.

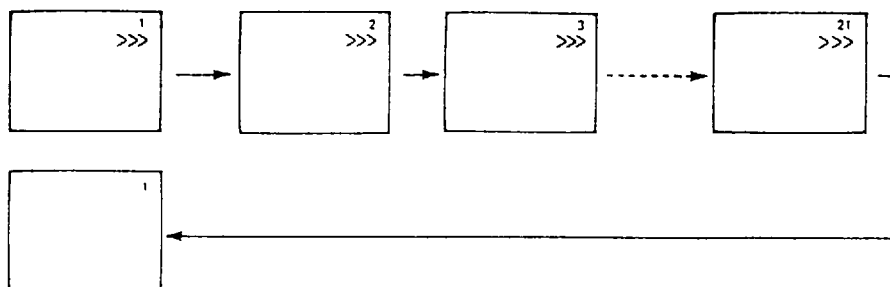

3. After all channels are memorized, the search goes to the position 20 and returns to the position 1 to end the operation.
4. When you desire to memorize the same contents to the position 21 and larger, select the position 21 and press the AUTO SEARCH MEMORY button ⑤ again. After the channels are memorized, the search goes to the position 29 and returns to the position 21 to end the operation.

This TV receiver can memorize 30 channels of station on the desired position number, 3 ways of channel memorization are prepared; namely ASM, U/V SEARCH and MFT.

## ■ SOUND SELECT

When disturbance occurs in reception of sound multi broadcast (NICAM SYSTEM), SOUND SELECT SW shall be set to S1 or S2 side.

However the other system shall be set to AUTO side.

## ■ RECEIVING SYSTEM

### SYSTEM SWITCH ⑦ OPERATION

AUTO → PAL → SECAM → 443NTSC → 358NTSC



This TV receiver can receive 28 systems.

- AUTO All signals of 28 systems can be received.
- PAL PAL Signal can be received.
- SECAM SECAM Signal can be received.
- 4.43NTSC Signal from VCR on 4.43NTSC can be received.
- 3.58NTSC 3.58NTSC signal can be received. U.S. CHANNEL, JAPAN CHANNEL (PHILIPPINES, KOREA)

#### Note:

Colour system indication is displayed in green when the TV is switched on automatic mode and in cyanic when switched on manual mode.

## ■ COUNTERMEASURES AGAINST MALFUNCTION IN FRINGE AREA

### 1. In Case Abnormal Signals Were Memorized by Auto Search

If you mind this, reset the memory by MFT ③ (Manual Fine Tuning) from the position after the one where the abnormal signals were memorized.

### 2. System Selection When System Malfunction Occurs

System malfunction may occur in AUTO mode when unfavourable receiving conditions prevail. In this event, use manual mode which matches the system of receiving signals.

#### Example:

- (1) In the case of receiving successive channels.
- (2) In using video tape reproduced repeatedly.
- (3) When receiving different systems in the vicinity of border where receiving conditions are bad.
- (4) In the area where strong and weak electric fields are mixed in the channels.

## EXTERNAL EQUIPMENT CONNECTION (VCR)

### 1 TO CONNECT VCR FOR PICTURE RECORDING AND PLAY-BACK

#### HOW TO CONNECT VCR

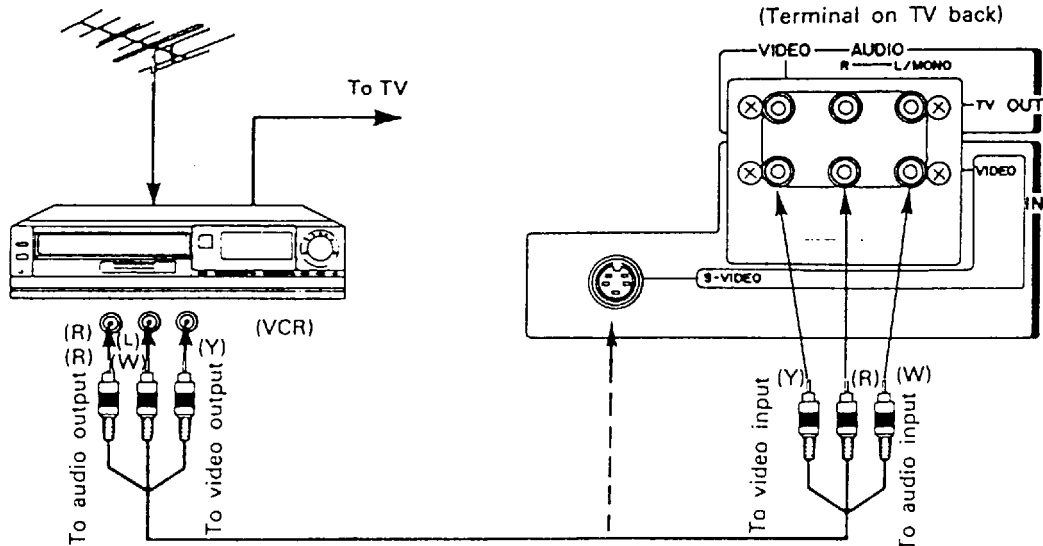

#### VCR PROVIDED WITH S-VIDEO TERMINAL

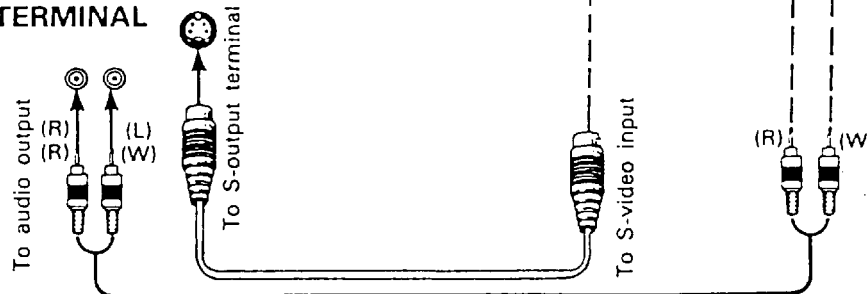

#### HOW TO USE

When recording	When playing back
<ol style="list-style-type: none"> <li>1 Select the TV program to be recorded on the side of VCR to put it in the recording position.</li> <li>2 To monitor the recording condition, put the TV set in "VIDEO" mode by pressing VIDEO button on the TV.</li> </ol>	<ol style="list-style-type: none"> <li>1 Get into "VIDEO" mode by pressing VIDEO button on the TV set.</li> <li>2 Set VCR in the play-back position.  <b>Note:</b> To view a TV program after play-back, put it in the "TV" position by pressing the TV/VIDEO button.</li> </ol>
<b>To record background TV program</b>	
<ol style="list-style-type: none"> <li>1 Set the VCR in the recording position by taking the steps as mentioned in the above "When recording."</li> <li>2 Press the TV/VIDEO SELECTION button of VCR to put it into "TV" mode.</li> <li>3 You may view TV program as you like by pressing CHANNEL button of the TV.</li> </ol>	

#### NOTE:

- Be sure to read the "Operation Manual" of the VCR you use as well.
- It is operable also with the video input terminal.
- When viewing TV program with the connection exemplified above (connection through VCR to antenna lead-in), turn off the power of VCR or press TV/VIDEO button to get into the "TV" mode.
- S-video terminal is a separate TC signal terminal.
- Do not use the video terminal concurrently with the S-video input terminal.  
Use audio terminal of the video mode terminals.

## (Stereo & Video Camera)

### 2 WHEN CONNECTING STEREO UNIT

Example: When using TV output terminal

- Sound volume is controlled in the side of stereo unit.  
(Useful when recording.)

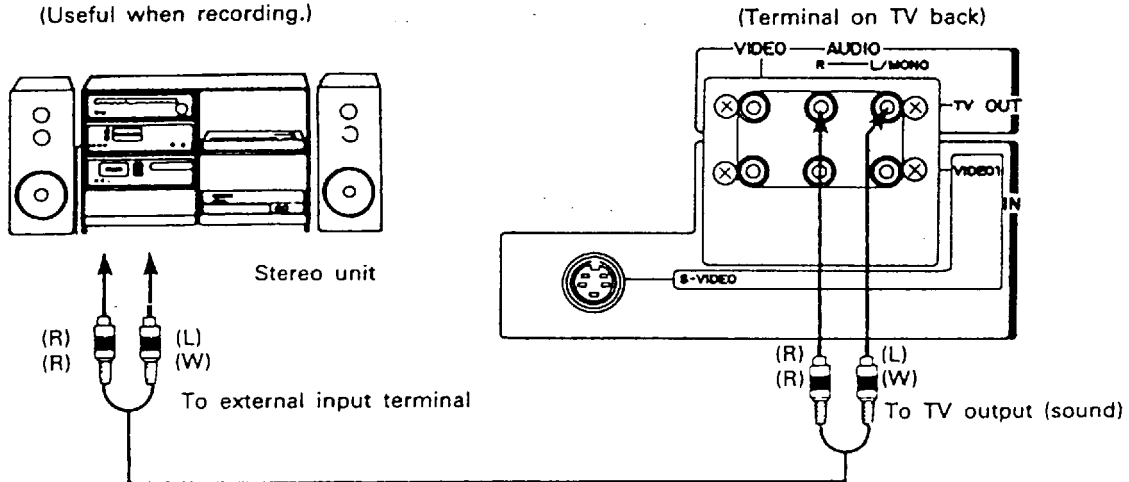

#### HOW TO USE

- 1 Mute the sound of TV speaker.
- 2 Sound volume should be adjusted in the stereo side.

#### NOTE:

- To avoid machine trouble, never use a set of speakers commonly for TV and stereo unit.
- Please read the "Operation Manual" of the stereo unit you use as well.

### 3 IF VIDEO CAMERA IS CONNECTED FOR PLAY-BACK

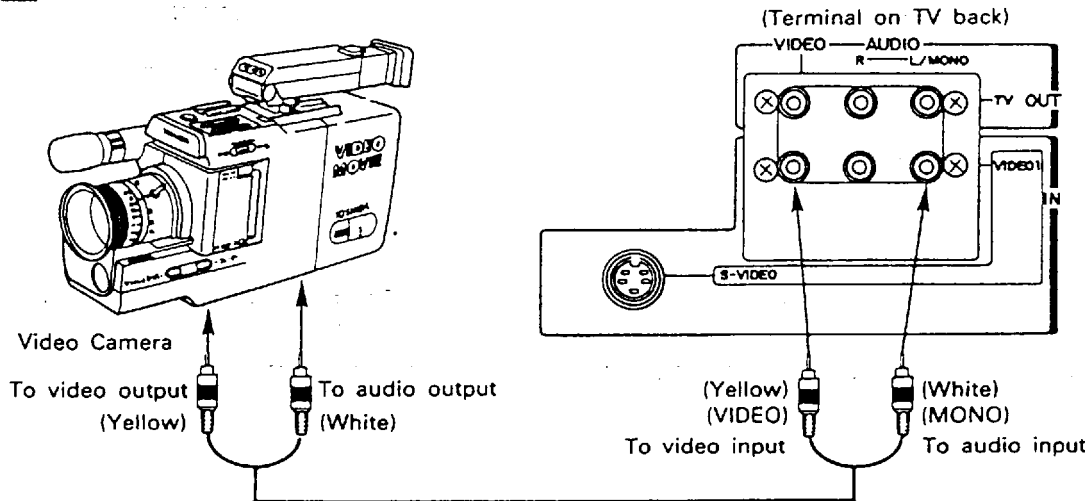

#### HOW TO USE

When playing back

- 1 Press VIDEO button of either TV or Remote Control Hand Unit to put the set in "VIDEO" mode.
- 2 Set the VCR in the play-back position.

#### NOTE:

- In case audio output of the VCR is monaural, connect to Left/Mono terminal.
- If a speaker is placed on the TV, unevenness of colour may result. In this event, put it away from the TV set.

## EXTERNAL EQUIPMENT CONNECTION (EXTERNAL SPEAKERS)

### 4 CONNECTING EXTERNAL SPEAKERS

Before connecting the external speakers, turn the TV set off.

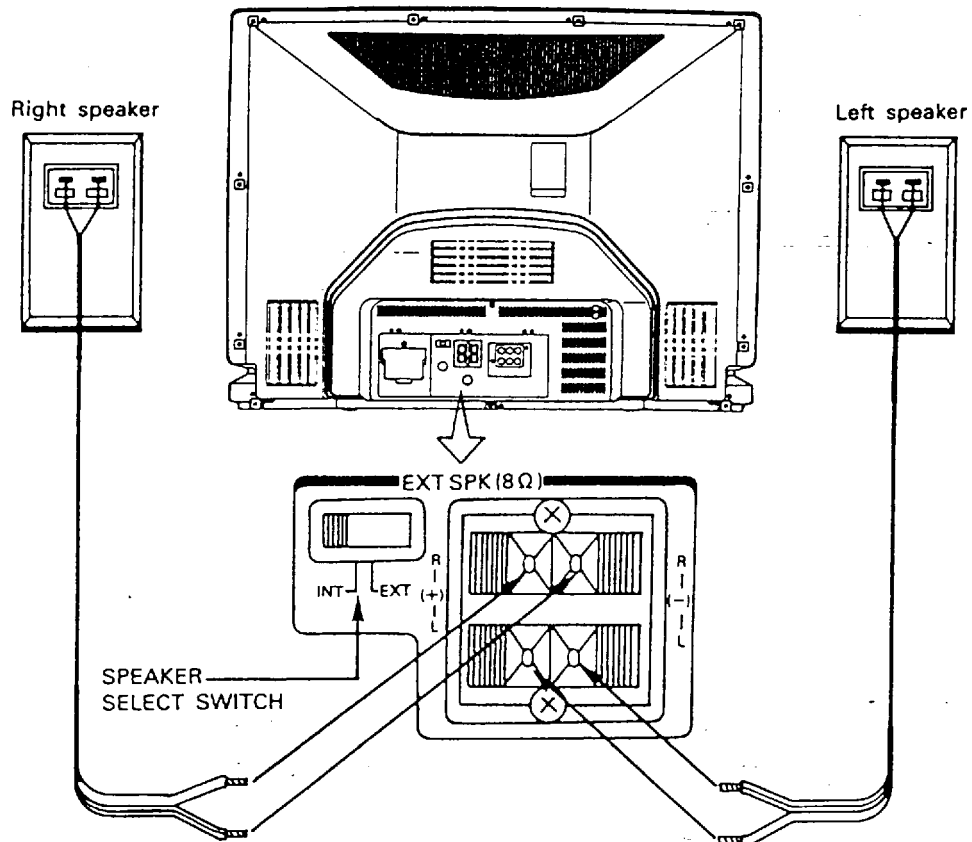

#### 1 Connect speaker leads

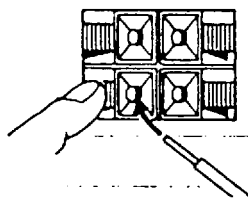

While pressing the button, insert the wire into the hole, then release the button. Pull firmly on the connection to make sure it is secure. Make sure connection of the wire is proper (R-L and  $\oplus$   $\ominus$ ).

#### 2 Set the SPEAKER SELECT Switch



Switch it to "EXT" side (right). The built-in speaker sound is disconnected.

#### NOTE:

- Do not connect two sound sources to the same speaker system. This may damage the TV. See the right figure.
- Use only external speakers with an impedance rating of 8 ohms and input power 7 watts or more.

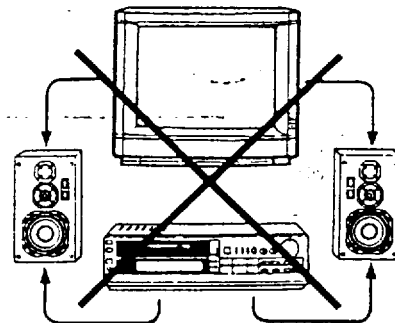

## 5 USE OF HEADPHONE

For private listening, connect a headphone (optional) to the HEADPHONE jack. The sound from the speakers will be cut off automatically.

(Behind the door)

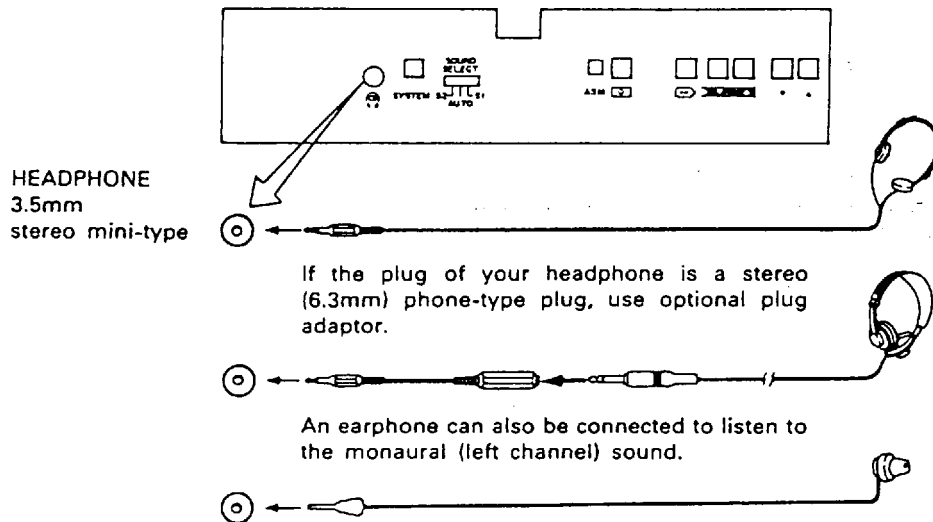

## 6 OPTIONAL ACCESSORIES

OPTIONAL ACCESSORIES ARE AVAILABLE FOR VARIOUS COMBINATION OF EXTERNAL EQUIPMENT CONNECTIONS.

- When connecting video/audio equipment to this TV set, you can choose the optional parts as shown below.

### CONNECTING CORD

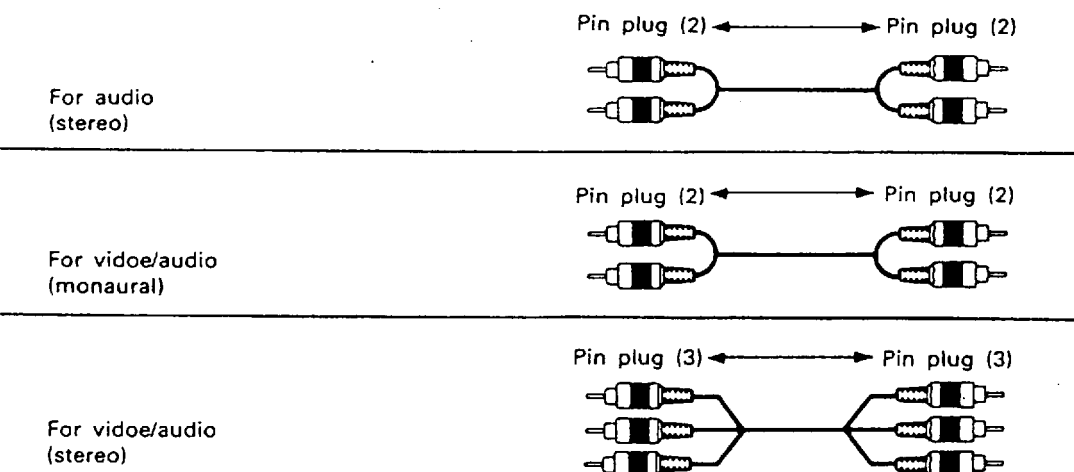

**WARNING:** BEFORE SERVICING THIS CHASSIS, READ THE "X-RAY RADIATION PRECAUTION", "SAFETY PRECAUTION" AND "PRODUCT SAFETY NOTICE" ON PAGE 2 OF THIS MANUAL.

## INSTALLATION AND SERVICE ADJUSTMENTS

### GENERAL INFORMATION

All adjustments are thoroughly checked and corrected when the receiver leaves the factory. Therefore the receiver should operate normally and produce proper colour and B/W pictures upon installation. However, several minor adjustments may be required depending on the particular location in which the receiver is operated.

This receiver is shipped completely in cardboard carton. Carefully draw out the receiver from the carton and remove all packing materials. Plug the power cord into a convenient 110 ~ 245 volts 50/60Hz AC two pin power outlet.

Turn the receiver ON and adjust the FINE TUNING for best picture detail with the AFC turned OFF.

Check and adjust all the customer controls such as BRIGHTNESS, CONTRAST and COLOUR Controls to obtain natural colour or B/W picture.

### AUTOMATIC DEGAUSSING

A degaussing coil is mounted around the picture tube so that external degaussing after moving the receiver is normally unnecessary, providing the receiver is properly degaussed upon installation. The degaussing coil operates for about 1 second after the power to the receiver is switched ON. If the set is moved or faced in a different direction, the power switch must be switched off at least one hour in order that the automatic degaussing circuit operates properly.

Should the chassis or parts of the cabinet become magnetized to cause poor colour purity, use an external degaussing coil. Slowly move the degaussing coil around the faceplate of the picture tube, the sides and front of the receiver and slowly withdraw the coil to a distance of about 2 m before disconnecting it from AC source. If colour shading still persists, perform the COLOUR PURITY ADJUSTMENT and CONVERGENCE ADJUSTMENTS procedures, as mentioned later.

### +145 VOLT POWER SUPPLY ADJUSTMENT (R851)

**CAUTION:** +B voltage closely relates to the high voltage.

To prevent hazardous X-RAY RADIATION, the +B voltage must be properly adjusted to +145 volts.

1. Tune in an active channel. Adjust the BRIGHTNESS and CONTRAST Controls for normal picture.
2. Check that the AC power Line voltage is normal. (AC 220 volts, 50 Hz)
3. Connect a VTVM between L805 on POWER Board and chassis ground.
4. Adjust the +B ADJ. (R851) on POWER Board for +145 volts reading. Remove the VTVM.

### HIGH VOLTAGE CHECK

**CAUTION:** There is no HIGH VOLTAGE ADJUSTMENT on this chassis.

1. Connect an accurate high voltage meter to the second anode of the picture tube.
2. Turn on the receiver. Set the BRIGHTNESS and CONTRAST Controls to minimum (zero beam current).
3. High voltage will be measured below 32kV.
4. Rotate the BRIGHTNESS Control to both extremes to be sure the high voltage does not exceed the limit of 32kV under any conditions.

### HEIGHT ADJUSTMENT

HEIGHT Control (R351) on Back Terminal Board changes the size of the picture or pattern, having an equal effect on the top and bottom. Make final adjustment to overscan the mask 2 cm at top and bottom.

### FOCUS ADJUSTMENT

Adjust FOCUS Control on FLYBACK TRANS.(T461) for well defined scanning lines in the centre area on the screen.

### HORIZONTAL CENTER ADJUSTMENT

1. Receive the WG PHILIPS pattern.
2. Set the contrast and colour to minimum, and the brightness to maximum.
3. Adjust H. CENTER Control (R451) so the pattern center can be located at the screen center.

### PICTURE WIDTH AND DISTORTION ADJUSTMENT (Width, Pincusion Distortion, Trapezoid Distortion)

1. Perform this adjustment after +B and H. CENTER adjustment are completed.
2. Receive the WG PHILIPS pattern.
3. Set the contrast and colour to minimum, and the brightness to maximum.
4. Adjust H. WIDTH Control (RD50) for the horizontal width so that the white flags on left and right of the pattern are just hidden.
5. Adjust DPC Control (RD51) to correct the vertical line on left and right straight.
6. Readjust WIDTH Control (RD50) for the precision.

### BELL COIL (LM01) ADJUSTMENT

1. Receive SECAM colour bar signal.
2. Connect the synchroscope to the terminal Pin 2 of LM01.
3. Adjust LM01 for the flat level of amplitude in each colour bar waveform on the scope. (See figure 1.)

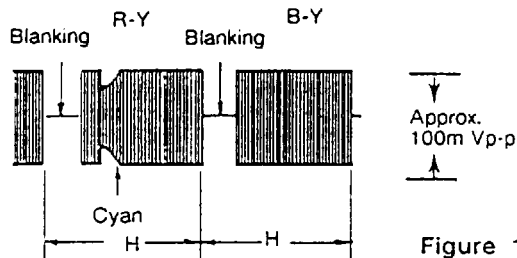

Figure 1.

### IDENT COIL (LM04) ADJUSTMENT

1. Receive SECAM colour bar signal.
2. Connect the DC voltmeter (Digital Voltmeter) to the pin 23 of IC501.
3. Adjust LM04 for the maximum indication (approx. DC10V) on the meter.

### B-Y, R-Y DEMOD COIL (LM02, LM03) ADJUSTMENT

1. Receive SECAM colour bar signal.
2. Set the COLOUR, BRIGHTNESS and CONTRAST Controls free.
3. Connect the synchroscope to the pin 62 of IC501.
4. Adjust LM02 so that the white level in picture part reaches to the vertical retrace line. (See figure 2.)
5. Then change the connection of synchroscope from the pin 62 to the pin 60 of IC501.
6. Adjust LM03 so that the white level in picture part reaches to the vertical retrace line. (See figure 3.)

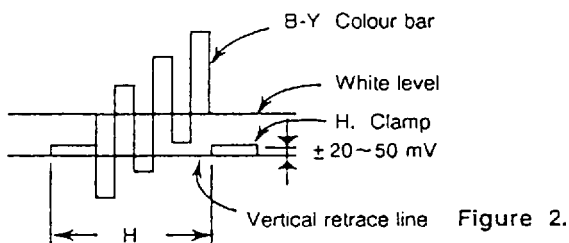

Figure 2.

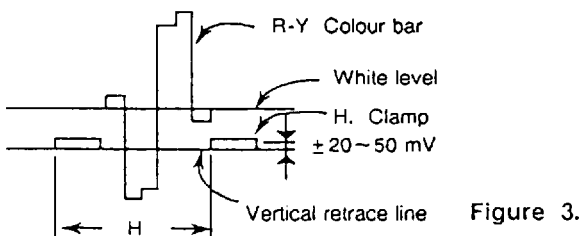

Figure 3.

### PAL MATRIX ADJUSTMENT

1. Tune in the colour programme PAL Philips pattern.
2. Set the COLOUR Control VR. to obtain the proper colour.
3. If the PAL MATRIX adjustment is in correct, the venetian Blind would appear in the colour bars area. The case needs the adjustment.
4. At the first, adjust DL PHASE ADJ. Coil (L551) to minimize the Venetian Blind.
5. Next adjust 1H-DL ADJ. VR (R551) to minimize the Blind.
6. Remove the capacitor, and if the Venetian Blind still remains, adjust 1H-DL PHASE ADJ. Coil (L551) to minimize the Blind again.
7. Repeat the item 5 and 6 procedures, adjust the R551 and L551 until the Blind does not appear when the capacitor is connected.

### SIF DET. ADJUSTMENT L674 FOR 6.0MHz

1. Supply +12V to the System Switch Board.
2. Connect 10k ohm resistor between pin 18 of IC670 and ground.
3. Connect the 6.0MHz signal (Modulation: 400Hz/15kHz deviation, 100dB $\mu$ ) of SIF S.G. to pin 9 of IC670 through a capacitor 0.01  $\mu$ F.
4. Connect the millivoltmeter to pin 9 of IC674.
5. Adjust L674 for the maximum reading on the meter.

### C651 FOR 4.5MHz

1. Supply +12V to the System Switch Board.
2. Connect 10k ohm resistor between pins 18 and 22 of IC670.
3. Connect the 4.5MHz signal (Modulation: 400Hz/7.5kHz deviation, 100dB $\mu$ ) of SIF S.G. to pin 25 of IC670 through a capacitor 0.01  $\mu$ F.
4. Connect the millivoltmeter to pin 9 of IC674.
5. Adjust the variable capacitor (C651) for the maximum reading on the meter.

### SIF DET. ADJUSTMENT 6.0MHz OSC. COIL (L672)

1. Supply +12V to the System SW. Board.
2. Connect 10k ohm resistor between pin 18 of IC670 and ground.
3. Apply the 6.0MHz signal (No modulation, 100dB $\mu$ ) of SIF S.G. to Base of QN40 through a capacitor 0.01  $\mu$ F.
4. Connect oscilloscope to pin 9 of IC674.
5. Adjust L672 so that the response on oscilloscope can be maximum.

### SIF DET. ADJUSTMENT 5.5MHz OSC. COIL (L671)

1. Supply +12V to the SYSTEM SW. Board.
2. Supply +9V to Anode of D402 through 10k ohm resistor.
3. Apply the 5.5MHz signal (No modulation, 100dB $\mu$ ) of SIF S.G. to pin 27 of IC670 through a capacitor 0.01  $\mu$ F.
4. Connect oscilloscope or DC voltmeter to pin 18 of IC670.
5. Adjust L671 so that the response on oscilloscope or DC voltmeter can become +4.5V.

## COLOUR PURITY ADJUSTMENT

**Note :** Before attempting any purity adjustments, the receiver should be operated for at least fifteen minutes. Purity adjustment requires Rubber Wedge kit.

1. Demagnetize the picture tube and cabinet using a degaussing coil.
2. Turn the CONTRAST and BRIGHTNESS Controls to maximum.
3. Adjust RED and BLUE CUT OFF controls (R557 and R559) to provide only a green raster. Advance the GREEN CUT OFF control (R558) if necessary.
4. Loosen the clamp screw holding the yoke, and slide the yoke backward or forward to provide vertical green belt (zone) in the picture screen.
5. Remove the Rubber Wedges.
6. Rotate and spread the tabs of the purity magnet (See figure 5) around the neck of the picture tube until a green belt is obtained in the centre of the screen. And at the same time, centre the raster vertically by adjusting the magnet.
7. Move the yoke slowly forward or backward until a uniform green screen is obtained. Tighten the clamp screw.
8. Check the purity of the red and blue raster by adjusting the CUT OFF Controls.
9. Tighten the clamp screw of the yoke temporarily.
10. Obtain a white raster; referring to "CRT GREY SCALE ADJUSTMENT".
11. Proceed with convergence adjustment.

## CRT GREY SCALE ADJUSTMENT

1. Tune in an active channel.
2. Turn the SCREEN Control (on T461) fully counterclockwise.
3. Set the RED, GREEN and BLUE CUT OFF Controls (R557, R558, R559) to the mid position.
4. Set the GREEN and BLUE DRIVE Controls (R252, R253) to the mid position.
5. Set the SERVICE SW. (S202) in the H. line position.
6. Set the CONTRAST, COLOUR Controls to minimum and BRIGHTNESS Control to centre position.
7. Rotate the SCREEN Control gradually clockwise until the first line appears slightly on the screen. Then turn fully counterclockwise the two CUT OFF Controls corresponding to the colours of the first and the second horizontal lines to eliminate the lines.
8. Rotate the SCREEN Control gradually clockwise until the first horizontal line of a colour (RED, GREEN or BLUE) appears slightly on the screen. Set the SCREEN Control to this position. At the base of the colour, rotate the remaining two CUT OFF Controls gradually clockwise until the horizontal lines of each colour appear slightly on the screen.
9. Adjust the CUT OFF Controls to obtain the slightly lighted horizontal lines in the same levels of three colours (RED, GREEN and BLUE). The lines may look like white if the CUT OFF Controls are adjusted properly.
10. Return the SERVICE SW. (S202) in the Receiving position.
11. Set the BRIGHTNESS Control to the maximum and COLOUR control to the minimum.
12. Adjust the BLUE and GREEN DRIVE Controls (R252/ R253) to obtain proper white-balanced picture in high light areas.
13. Set the BRIGHTNESS and CONTRAST Controls to obtain dark grey raster. Then check the white balance in low brightness. If the white balance is not proper, retouch the CUT OFF Controls and DRIVE Controls to obtain a good white balance in both low and high light areas.

## SUB-BRIGHTNESS ADJUSTMENT

1. Tune in a colour programme.
2. Set the CONTRAST Control to the maximum and the BRIGHTNESS Control to the centre.
3. Set the COLOUR Control to the centre.
4. Set the SUB-BRIGHT. Control (R255) to the centre and leave the receiver for five minutes in this state.
5. Watching the picture well, adjust the SUB-BRIGHT. Control in the position where the picture does not show evidence of blooming in high bright area and not appear too dark in low bright portion.
6. Check the proper picture variation by rotating the CONTRAST and BRIGHTNESS Controls to both extremes.
7. If the picture does not appear dark with the CONTRAST and BRIGHTNESS Controls turned to the minimum, or not appear bright with the controls turned to the maximum, adjust the SUB-BRIGHT. Control again for the acceptable picture.

## CONVERGENCE ADJUSTMENTS

**Note :** Before attempting any convergence adjustments, the receiver should be operated for at least fifteen minutes.

### ■ Centre Convergence Adjustment

1. Receive crosshatch pattern with a colour bar signal generator.
2. Adjust the BRIGHTNESS and CONTRAST Controls for well defined pattern.
3. Adjust two tabs of the 4-Pole Magnets to change the angle between them (See figure 5.) and superimpose red and blue vertical lines in the centre area of the picture screen. (See figure 6.)
4. Turn the both tabs at the same time keeping the constant angle to superimpose red and blue horizontal lines at the centre of the screen. (See figure 6.)
5. Adjust two tabs of 6-Pole Magnets to superimpose red/blue line and green one. Adjusting the angle affects the vertical lines and rotating both magnets affects the horizontal lines.
6. Repeat adjustments 3, 4, 5 with understanding red, green and blue movement, because 4-Pole Magnets and 6-Pole Magnets have mutual affection and it makes dots movement complex.

### ■ Circumference Convergence Adjustment

1. Loosen the clamping screw of deflection yoke to allow the yoke to tilt.
2. Put a wedge as shown in figure 4. temporarily. (Do not remove cover paper on adhesive part of the wedge.)
3. Tilt front of the deflection yoke up or down to obtain better convergence in circumference. (See figure 6.) Push the mounted wedge into the space between picture tube and yoke to fix the yoke temporarily.
4. Put other wedge into bottom space and remove the cover paper to stick.
5. Tilt front of the yoke right or left to obtain better convergence in circumference. (See figure 6.)
6. Keep the yoke position and put another wedge in either upper space. Remove cover paper and stick the wedge on picture tube to fix the yoke.
7. Detach the temporarily mounted wedge and put it in another upper space. Stick it on picture tube to fix the yoke.
8. After fixing three wedges, recheck overall convergence. Tighten the screw firmly to fix the yoke and check the yoke is firm.
9. Stick 3 adhesive tapes on wedges.



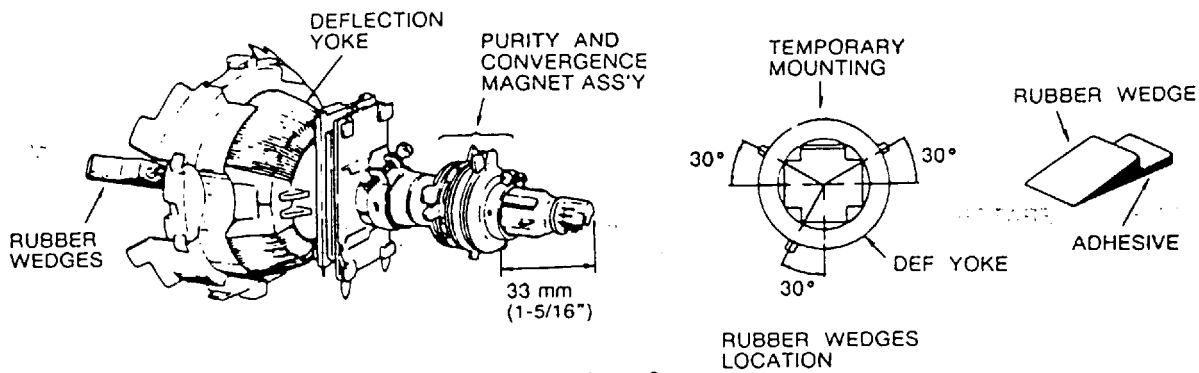

Figure 4.

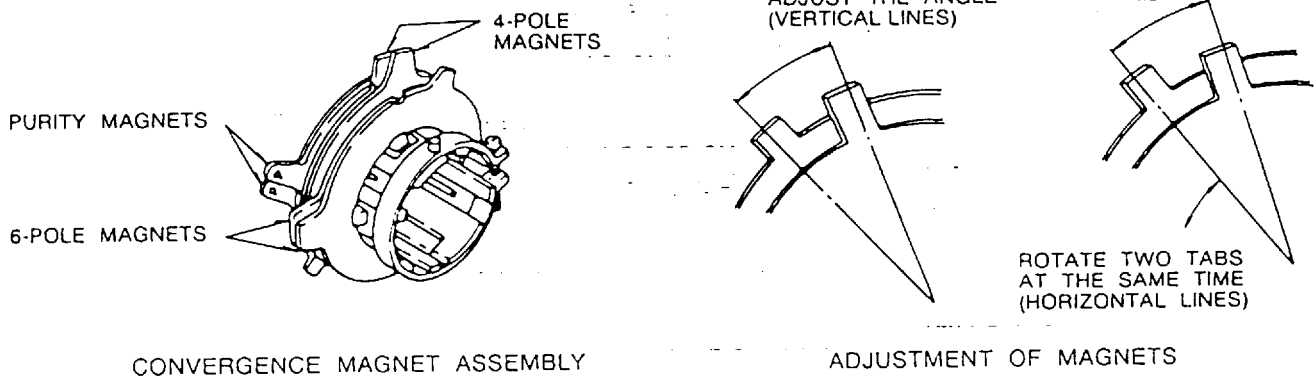
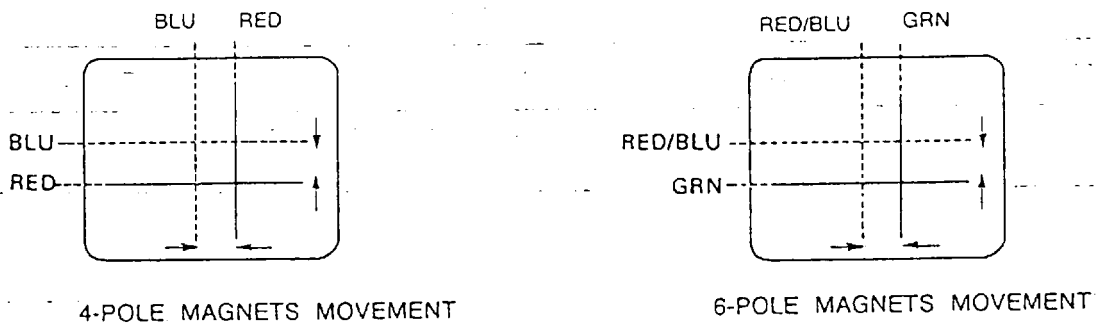

Figure 5.



Center Convergence by Convergence Magnets

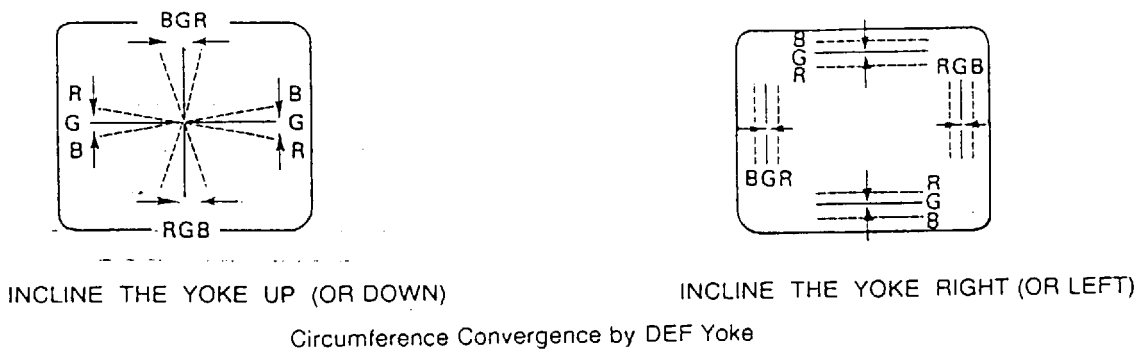

Figure 6. Dot Movement Pattern.

## PICTURE I-F TRAP ALIGNMENT

- GENERAL ..... Refer to Figure 7 for the equipment connection.
- PRELIMINARY STEPS ..... 1. Disconnect the jumper wire (on the tuner IF output line) on the component side of the MAIN Board.  
2. Supply +12 volts to the MAIN Board.
- SWEEP/MARKER GENERATOR..... Connect to the point ④ as shown in Figure 7 on the MAIN Board.
- OSCILLOSCOPE..... Connect through the detector (See Figure 9.) to the emitter of Q181 on the System SW board.

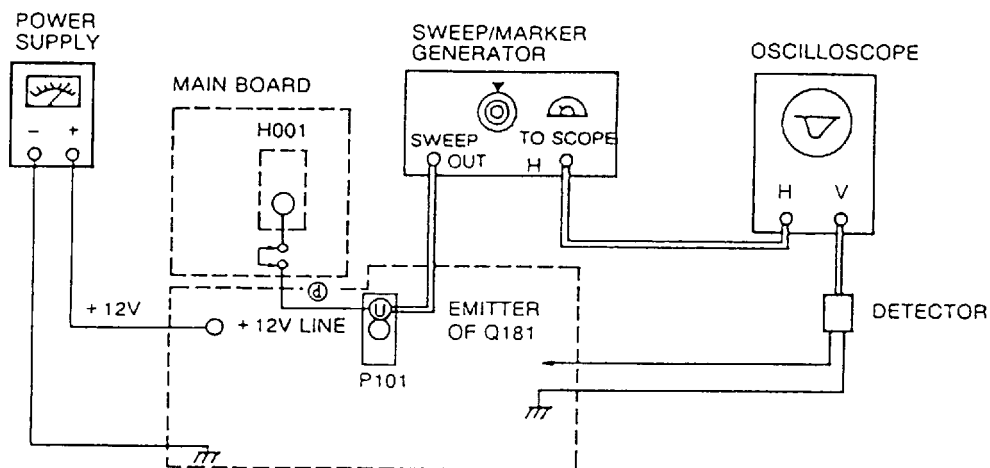

Figure 7. I-F TRAP Alignment

STEP	SWEEP/MARKER GENERATOR	ADJUST	PROCEDURE
<b>T181 33.5 MHz/T182 32.0 MHz TRAP ALIGNMENT</b> Control the sweep output for easy alignment. Set the system SW to 3.58 NTSC system.			
4.5 MHz Trap Coil	33.5MHz Marker "ON"	T181	<ul style="list-style-type: none"> <li>Set the IF Marker for 33.5 MHz (P-4.5M)</li> <li>Adjust T181 so that 33.5 MHz marker point is placed at bottom of response. (See Figure 8)</li> </ul>
6.0 MHz Trap Coil	32.0MHz Marker "ON"	T182	<ul style="list-style-type: none"> <li>Set the IF Marker for 32.0 MHz (P-6.0M)</li> <li>Adjust T182 so that 32.0 MHz marker point is placed at bottom of response. (See Figure 8)</li> </ul>

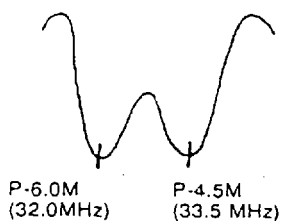

Figure 8. Trap Response

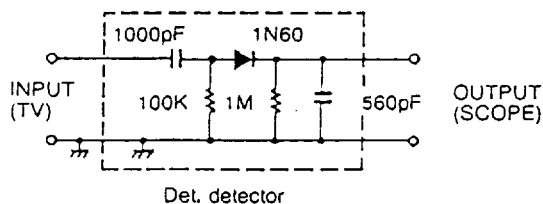
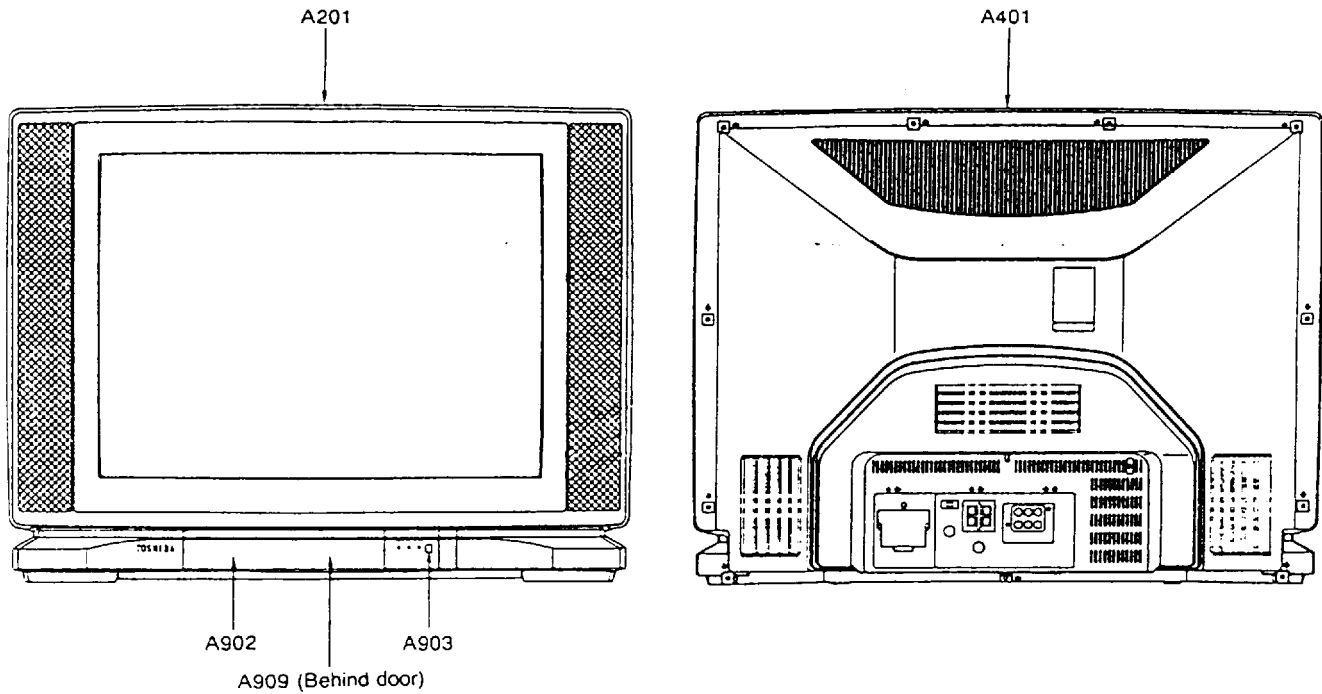

Figure 9. Detector Diagram

## CABINET REPLACEMENT PARTS LIST



Location No.	Part No.	Description
A201	23418904	Front Cover
A401	23424155	Back Cover
A701	23523802	Carton Box
A702	23934151	Packing
A703	23941794	Sheet
A705	23931746	Separator
A902	23424199	Door
A903	23443547	Knob, POWER
A904	23451068	Push Catch
A905	70354038	Dumper
A906	23805265	Leg (Left)
A907	23805264	Leg (Right)
A909	23443525	Knob, 7-key
Y101A	23561098	Owner's Guidebook
Y108	23122780	AC Adaptor, 2P
Y111	23164720	Connector
Y123	23994860	Sheet
Y124	23293988	Adapter, Aerial Matching

## CHASSIS REPLACEMENT PARTS LIST

**WARNING:** BEFORE SERVICING THIS CHASSIS, READ THE "X-RAY RADIATION PRECAUTION", "SAFETY PRECAUTION" AND "PRODUCT SAFETY NOTICE" ON PAGE 2 OF THIS MANUAL.

**CAUTION:** The international hazard symbols in the schematic diagram and the parts list designate components which have special characteristics important for safety and should be replaced only with types identical to those in the original circuit or specified in the parts list. The mounting position of replacements is to be identical with originals. Before replacing any of these components, read carefully the PRODUCT SAFETY NOTICE on page 2. Do not degrade the safety of the receiver through improper servicing.

**NOTICE:** The part number must be used when ordering parts, in order to assist in processing, be sure to include the Model number and Description.

### ABBREVIATIONS:

Capacitors.....	CD : Ceramic Disk	PF : Plastic Film	EL : Electrolytic
Resistors.....	CF : Carbon Film	CC : Carbon Composition	MF : Metal Film
	OMF : Oxide Metal Film	VR : Variable Resistor	FR : Fusible Resistor

(All CD and PF capacitors are  $\pm 5\%$ , 50V and all resistors,  $\pm 5\%$ , 1/6W unless otherwise noted.)

Location No.	Part No.	Description
<b>CAPACITORS</b>		
C173	24538104	PF, 0.1 $\mu$ F
C181	24232103	CD, 0.01 $\mu$ F, +80%, -20%
C182	24232103	CD, 0.01 $\mu$ F, +80%, -20%
C183	24232103	CD, 0.01 $\mu$ F, +80%, -20%
C184	24212102	CD, 1000pF, $\pm 10\%$
C201	24636100	EL, 10 $\mu$ F, 50V
C202	24763471	EL, 470 $\mu$ F, $\pm 20\%$ , 16V
C203	24232103	CD, 0.01 $\mu$ F, +80%, -20%
C204	24797220	EL, 22 $\mu$ F, $\pm 20\%$ , 50V
C205	24206478	EL, 0.47 $\mu$ F, 50V
C208	24212102	CD, 1000pF, $\pm 10\%$
C209	24232103	CD, 0.01 $\mu$ F, +80%, -20%
C210	24636100	EL, 10 $\mu$ F, 50V
C217	24203470	EL, 47 $\mu$ F, $\pm 20\%$ , 16V
C218	24203220	EL, 22 $\mu$ F, $\pm 20\%$ , 16V
C219	24436270	CD, 27pF
C220	24538474	PF, 0.47 $\mu$ F
C301	24636229	EL, 2.2 $\mu$ F, 50V
C302	24212152	CD, 1500pF, $\pm 10\%$
C303	24617915	EL, 1 $\mu$ F, $\pm 10\%$ , 50V
C304	24212102	CD, 1000pF, $\pm 10\%$
C306	24693563	PF, 0.056 $\mu$ F, 100V
C307	24232103	CD, 0.01 $\mu$ F, +80%, -20%
C311	24796222	EL, 2200 $\mu$ F, $\pm 20\%$ , 35V
C314	24214391	CD, 390pF, $\pm 10\%$ , 500V
C316	24795472	EL, 4700 $\mu$ F, $\pm 20\%$ , 25V
C317	24617912	EL, 2.2 $\mu$ F, $\pm 10\%$ , 50V
C318	24082047	PF, 0.033 $\mu$ F, 100V
C319	24693272	PF, 2700pF, 100V
C320	24214152	CD, 1500pF, $\pm 10\%$ , 500V
C323	24592103	PF, 0.01 $\mu$ F, $\pm 10\%$
C325	24796221	EL, 220 $\mu$ F, $\pm 20\%$ , 35V
C327	24693104	PF, 0.1 $\mu$ F, 100V
C330	24794471	EL, 470 $\mu$ F, $\pm 20\%$ , 16V
C331	24095678	PF, 0.22 $\mu$ F, $\pm 10\%$ , 100V
C401	24636010	EL, 1 $\mu$ F, 50V
C402	24353241	CD, 240pF
C403	24636339	EL, 3.3 $\mu$ F, 50V
C405	24593203	PF, 0.02 $\mu$ F
C406	24593203	PF, 0.02 $\mu$ F

Location No.	Part No.	Description
C407	24593243	PF, 0.024 $\mu$ F
C408	24617929	EL, 18 $\mu$ F, $\pm 20\%$ , 50V
C409	24232103	CD, 0.01 $\mu$ F, +80%, -20%
C413	24593182	PF, 1800pF
C416	24214222	CD, 2200pF, $\pm 10\%$ , 500V
C417	24214331	CD, 330pF, $\pm 10\%$ , 500V
C418	24677100	EL, 10 $\mu$ F, $\pm 20\%$ , 160V
C420	24436331	CD, 330pF
△C440	24082166	PF, 6800pF, $\pm 3\%$ , 2kV
C442	24214221	CD, 220pF, $\pm 10\%$ , 500V
△C444	24095773	PF, 3600pF, $\pm 3\%$ , 2kV
C445	24828473	PF, 0.047 $\mu$ F, 200V
C446	24640962	EL, 33 $\mu$ F, $\pm 20\%$ , 200V
C447	24640968	EL, 10 $\mu$ F, 400V
C448	24754222	EL, 2200 $\mu$ F, 25V
△C463	24212222	CD, 2200pF, $\pm 10\%$
C466	24794471	EL, 470 $\mu$ F, $\pm 20\%$ , 16V
C468	24538474	PF, 0.47 $\mu$ F
C470	24095790	PF, 0.22 $\mu$ F, 400V
C473	24095949	PF, 0.33 $\mu$ F, 200V
C474	24828303	PF, 0.03 $\mu$ F, 200V
C501	24763471	EL, 470 $\mu$ F, $\pm 20\%$ , 16V
C502	24636100	EL, 10 $\mu$ F, 50V
C503	24232103	CD, 0.01 $\mu$ F, +80%, -20%
C504	24353150	CD, 15pF
C505	24593273	PF, 0.027 $\mu$ F
C506	24593683	PF, 0.068 $\mu$ F
C507	24593103	PF, 0.01 $\mu$ F
C508	24085028	EL, 2.2 $\mu$ F, 25V, Non-Polar
C509	24353330	CD, 33pF
C510	24232103	CD, 0.01 $\mu$ F, +80%, -20%
C511	24232103	CD, 0.01 $\mu$ F, +80%, -20%
C512	24353200	CD, 20pF
C513	24436101	CD, 100pF
C514	24436101	CD, 100pF
C515	24636010	EL, 1 $\mu$ F, 50V
C516	24538104	PF, 0.1 $\mu$ F
C517	24538104	PF, 0.1 $\mu$ F
C518	24232103	CD, 0.01 $\mu$ F, +80%, -20%
C519	24232103	CD, 0.01 $\mu$ F, +80%, -20%
C520	24206478	EL, 0.47 $\mu$ F, 50V

Location No.	Part No.	Description
C521	24538474	PF, 0.47 $\mu$ F
C522	24538474	PF, 0.47 $\mu$ F
C523	24538474	PF, 0.47 $\mu$ F
C524	24232103	CD, 0.01 $\mu$ F, +80%, -20%
C525	24436820	CD, 82pF
C526	24436820	CD, 82pF
C527	24436820	CD, 82pF
C529	24353300	CD, 30pF
C530	24797220	EL, 22 $\mu$ F, $\pm$ 20%, 50V
C531	24797100	EL, 10 $\mu$ F, $\pm$ 20%, 50V
C532	24436101	CD, 100pF
C533	24436101	CD, 100pF
C534	24436101	CD, 100pF
C535	24206100	EL, 10 $\mu$ F, 50V
C536	24206478	EL, 0.47 $\mu$ F, 50V
C537	24794331	EL, 330 $\mu$ F, 16V
C540	24436301	CD, 300pF
C541	24436301	CD, 300pF
C542	24436301	CD, 300pF
C544	24436101	CD, 100pF
C601	24436471	CD, 470pF
C602	24436471	CD, 470pF
C613	24795470	EL, 47 $\mu$ F, $\pm$ 20%, 25V
C614	24634220	EL, 22 $\mu$ F, 25V
C615	24636479	EL, 4.7 $\mu$ F, 50V
C616	24636479	EL, 4.7 $\mu$ F, 50V
C617	24636479	EL, 4.7 $\mu$ F, 50V
C618	24636229	EL, 2.2 $\mu$ F, 50V
C619	24636010	EL, 1 $\mu$ F, 50V
C620	24538563	PF, 0.056 $\mu$ F
C621	24538103	PF, 0.01 $\mu$ F
C622	24794101	EL, 100 $\mu$ F, $\pm$ 20%, 16V
C623	24232103	CD, 0.01 $\mu$ F, +80%, -20%
C624	24085031	EL, 1 $\mu$ F, $\pm$ 20%, 25V, Non-Polar
C625	24797470	EL, 47 $\mu$ F, $\pm$ 20%, 50V
C626	24085031	EL, 1 $\mu$ F, $\pm$ 20%, 25V, Non-Polar
C627	24538103	PF, 0.01 $\mu$ F
C628	24538563	PF, 0.056 $\mu$ F
C629	24538224	PF, 0.22 $\mu$ F
C630	24636100	EL, 10 $\mu$ F, 50V
C631	24636479	EL, 4.7 $\mu$ F, 50V
C632	24636229	EL, 2.2 $\mu$ F, 50V
C633	24636479	EL, 4.7 $\mu$ F, 50V
C634	24593122	PF, 1200pF
C635	24794470	EL, 47 $\mu$ F, $\pm$ 20%, 16V
C636	24636010	EL, 1 $\mu$ F, 50V
C637	24794470	EL, 47 $\mu$ F, $\pm$ 20%, 16V
C638	24636010	EL, 1 $\mu$ F, 50V
C639	24636229	EL, 2.2 $\mu$ F, 50V
C640	24538224	PF, 0.22 $\mu$ F
C641	24797471	EL, 470 $\mu$ F, $\pm$ 20%, 50V
C642	24794470	EL, 47 $\mu$ F, $\pm$ 20%, 16V
C643	24538104	PF, 0.1 $\mu$ F
C644	24795102	EL, 1000 $\mu$ F, $\pm$ 20%, 25V
C645	24538104	PF, 0.1 $\mu$ F
C646	24795102	EL, 1000 $\mu$ F, $\pm$ 20%, 25V
C647	24593122	PF, 1200pF
C651	24093950	Variable Capacitor, 5.5 to 30pF, 100V
C670	24232103	CD, 0.01 $\mu$ F, +80%, -20%
C671	24232103	CD, 0.01 $\mu$ F, +80%, -20%
C672	24212102	CD, 1000pF, $\pm$ 10%

Location No.	Part No.	Description
C673	24436471	CD, 470pF
C674	24436471	CD, 470pF
C675	24795101	EL, 100 $\mu$ F, 25V
C676	24436220	CD, 22pF
C677	24636010	EL, 1 $\mu$ F, 50V
C679	24232103	CD, 0.01 $\mu$ F, +80%, -20%
C680	24436470	CD, 47pF
C681	24436470	CD, 47pF
C682	24212102	CD, 1000pF, $\pm$ 10%
C683	24212222	CD, 2200pF, $\pm$ 10%
C684	24232103	CD, 0.01 $\mu$ F, +80%, -20%
C685	24763331	EL, 330 $\mu$ F, $\pm$ 20%, 16V
C686	24232103	CD, 0.01 $\mu$ F, +80%, -20%
C687	24353150	CD, 15pF
C688	24340220	CD, 22pF
C689	24353620	CD, 62pF
C690	24232103	CD, 0.01 $\mu$ F, +80%, -20%
C691	24436470	CD, 47pF
C692	24593562	PF, 5600pF
C693	24232103	CD, 0.01 $\mu$ F, +80%, -20%
C801	24095951	PF, 0.1 $\mu$ F, $\pm$ 20%, AC250V
C802	24094654	CD, 470pF, $\pm$ 20%, AC400V
C803	24094654	CD, 470pF, $\pm$ 20%, AC400V
C804	24094654	CD, 470pF, $\pm$ 20%, AC400V
C805	24094654	CD, 470pF, $\pm$ 20%, AC400V
C806	24082089	PF, 0.1 $\mu$ F, $\pm$ 20%, AC250V
C807	24797101	EL, 100 $\mu$ F, $\pm$ 20%, 50V
C808	24648339	EL, 3.3 $\mu$ F, 450V
C809	24092300	CD, 0.01 $\mu$ F, +80%, -20%, AC250V
C810	24538104	PF, 0.1 $\mu$ F
C811	24092281	CD, 4700pF, $\pm$ 20%, AC250V
C812	24092281	CD, 4700pF, $\pm$ 20%, AC250V
C813	24092281	CD, 4700pF, $\pm$ 20%, AC250V
C814	24092281	CD, 4700pF, $\pm$ 20%, AC250V
C815	24538104	PF, 0.1 $\mu$ F
C816	24794221	EL, 220 $\mu$ F, 16V
C817	24796471	EL, 470 $\mu$ F, 35V
C818	24086921	EL, 680 $\mu$ F, $\pm$ 20%, 250V
C819	24086921	EL, 680 $\mu$ F, $\pm$ 20%, 250V
C820	24636100	EL, 10 $\mu$ F, 50V
C824	24797221	EL, 220 $\mu$ F, $\pm$ 20%, 50V
C825	24212102	CD, 1000pF, $\pm$ 10%
C826	24538104	PF, 0.1 $\mu$ F
C827	24598561	PF, 560pF
C828	24636100	EL, 10 $\mu$ F, 50V
C829	24757470	EL, 47 $\mu$ F, 100V
C830	24095931	PF, 2200pF, 1600V
C831	24633100	EL, 10 $\mu$ F, 16V
C832	24092336	CD, 180pF, $\pm$ 10%, 2kV
C833	24086945	EL, 330 $\mu$ F, $\pm$ 20%, 200V
C834	24538104	PF, 0.1 $\mu$ F
C835	24214221	CD, 220pF, $\pm$ 10%, 500V
C836	24795222	EL, 2200 $\mu$ F, 25V
C837	24436561	CD, 560pF
C838	24598561	PF, 560pF
C839	24538474	PF, 0.47 $\mu$ F
C840	24636100	EL, 10 $\mu$ F, 50V
C844	24214221	CD, 220pF, $\pm$ 10%, 500V
C845	24795101	EL, 100 $\mu$ F, 25V
C846	24214221	CD, 220pF, $\pm$ 10%, 500V
C847	24797222	EL, 2200 $\mu$ F, $\pm$ 20%, 50V
C861	24092340	CD, 390pF, $\pm$ 10%, 2kV
C862	24636479	EL, 4.7 $\mu$ F, 50V

Location No.	Part No.	Description
C863	24095951	PF, 0.1 $\mu$ F, $\pm$ 20%, AC250V
C864	24092343	CD, 680pF, $\pm$ 10%, 2kV
C865	24214391	CD, 390pF, $\pm$ 10%, 500V
C866	24214391	CD, 390pF, $\pm$ 10%, 500V
C867	24538474	PF, 0.47 $\mu$ F
C869	24636100	EL, 10 $\mu$ F, 50V
C871	24214391	CD, 390pF, $\pm$ 10%, 500V
C872	24212101	CD, 100pF, $\pm$ 10%
C901(U904A)	24700479	EL, 4.7 $\mu$ F, $\pm$ 20%, 250V
C901(U904B)	24640987	EL, 2.2 $\mu$ F, 350V
C902(U904A)	24095923	PF, 4700pF, 1600V
C902(U904B)	24095981	PF, 2200pF, 1600V
CA01	24794470	EL, 47 $\mu$ F, $\pm$ 20%, 16V
CA02	24232103	CD, 0.01 $\mu$ F, +80%, -20%
CA03	24633100	EL, 10 $\mu$ F, 16V
CA04	24436300	CD, 30pF
CA05	24436300	CD, 30pF
CA06	24232103	CD, 0.01 $\mu$ F, +80%, -20%
CA07	24633100	EL, 10 $\mu$ F, 16V
CA08	24636100	EL, 10 $\mu$ F, 50V
CA11	24436391	CD, 390pF
CA12	24436221	CD, 220pF
CA13	24636229	EL, 2.2 $\mu$ F, 50V
CA14	24232103	CD, 0.01 $\mu$ F, +80%, -20%
CA15	24538104	PF, 0.1 $\mu$ F
CA16	24538104	PF, 0.1 $\mu$ F
CA17	24538104	PF, 0.1 $\mu$ F
CA18	24636229	EL, 2.2 $\mu$ F, 50V
CA19	24636010	EL, 1 $\mu$ F, 50V
CA20	24794331	EL, 330 $\mu$ F, 16V
CA21	24636229	EL, 2.2 $\mu$ F, 50V
CA22	24794471	EL, 470 $\mu$ F, $\pm$ 20%, 16V
CA23	24591472	PF, 4700pF
CA28	24212102	CD, 1000pF, $\pm$ 10%
CA35	24212561	CD, 560pF, $\pm$ 10%
CA37	24212102	CD, 1000pF, $\pm$ 10%
CA38	24636010	EL, 1 $\mu$ F, 50V
CB02	24436101	CD, 100pF
CB03	24436101	CD, 100pF
CD01	24796101	EL, 100 $\mu$ F, 35V
△ CD02	24095881	PF, 0.018 $\mu$ F, $\pm$ 3%, 630V
CD05	24591683	PF, 0.068 $\mu$ F
CD06	24668470	EL, 47 $\mu$ F, $\pm$ 20%, 35V
CD07	24668471	EL, 470 $\mu$ F, $\pm$ 20%, 35V
CD08	24538154	PF, 0.15 $\mu$ F
CD09	24538154	PF, 0.15 $\mu$ F
CD10	24206229	EL, 2.2 $\mu$ F, 50V
CD11	24640871	EL, 4.7 $\mu$ F, $\pm$ 20%, 100V
CD14	24538103	PF, 0.01 $\mu$ F
CD15	24206010	EL, 1 $\mu$ F, 50V
CM01	24436201	CD, 200pF
CM02	24436201	CD, 200pF
CM05	24232103	CD, 0.01 $\mu$ F, +80%, -20%
CM06	24357270	CD, 27pF
CM07	24538563	PF, 0.056 $\mu$ F
CM08	24232103	CD, 0.01 $\mu$ F, +80%, -20%
CM09	24232103	CD, 0.01 $\mu$ F, +80%, -20%
CM10	24436100	CD, 10pF, $\pm$ 0.25pF
CN10	24436101	CD, 100pF
CN11	24436330	CD, 33pF
CN13	24232103	CD, 0.01 $\mu$ F, +80%, -20%
CN14	24436470	CD, 47pF
CN15	24436300	CD, 30pF
CN16	24436470	CD, 47pF

Location No.	Part No.	Description
CN17	24436180	CD, 18pF
CN18	24232103	CD, 0.01 $\mu$ F, +80%, -20%
CN40	24232103	CD, 0.01 $\mu$ F, +80%, -20%
CN41	24436470	CD, 47pF
CN42	24436470	CD, 47pF
CS01	24636100	EL, 10 $\mu$ F, 50V
CS02	24591392	PF, 3900pF
CS03	24538153	PF, 0.015 $\mu$ F
CS04	24636229	EL, 2.2 $\mu$ F, 50V
CS05	24538563	PF, 0.056 $\mu$ F
CS07	24538223	PF, 0.022 $\mu$ F
CS09	24538563	PF, 0.056 $\mu$ F
CS12	24794101	EL, 100 $\mu$ F, $\pm$ 20%, 16V
CS13	24636479	EL, 4.7 $\mu$ F, 50V
CS14	24232103	CD, 0.01 $\mu$ F, +80%, -20%
CV01	24206010	EL, 1 $\mu$ F, 50V
CV02	24206010	EL, 1 $\mu$ F, 50V
CV03	24203100	EL, 10 $\mu$ F, $\pm$ 20%, 16V
CV04	24206010	EL, 1 $\mu$ F, 50V
CV05	24206010	EL, 1 $\mu$ F, 50V
CV06	24203100	EL, 10 $\mu$ F, $\pm$ 20%, 16V
CV07	24232103	CD, 0.01 $\mu$ F, +80%, -20%
CV11	24206010	EL, 1 $\mu$ F, 50V
CV12	24206010	EL, 1 $\mu$ F, 50V
CV14	24232103	CD, 0.01 $\mu$ F, +80%, -20%
CV15	24203100	EL, 10 $\mu$ F, $\pm$ 20%, 16V
CV16	24232103	CD, 0.01 $\mu$ F, +80%, -20%
CV17	24206010	EL, 1 $\mu$ F, 50V
CV19	24436101	CD, 100pF
CV21	24203100	EL, 10 $\mu$ F, $\pm$ 20%, 16V
CV22	24203220	EL, 22 $\mu$ F, $\pm$ 20%, 16V
CV63	24203100	EL, 10 $\mu$ F, $\pm$ 20%, 16V
CV66	24202221	EL, 220 $\mu$ F, $\pm$ 20%, 10V
CV67	24206010	EL, 1 $\mu$ F, 50V
CV68	24206010	EL, 1 $\mu$ F, 50V
CV69	24202221	EL, 220 $\mu$ F, $\pm$ 20%, 10V
CV70	24232103	CD, 0.01 $\mu$ F, +80%, -20%
CV71	24232103	CD, 0.01 $\mu$ F, +80%, -20%
CX02	24538104	PF, 0.1 $\mu$ F
CX03	24538104	PF, 0.1 $\mu$ F
CX04	24538104	PF, 0.1 $\mu$ F
CX09	24206010	EL, 1 $\mu$ F, 50V
CX10	24793101	EL, 100 $\mu$ F, 10V
CZ01	24203220	EL, 22 $\mu$ F, $\pm$ 20%, 16V
CZ02	24203101	EL, 100 $\mu$ F, $\pm$ 20%, 16V
CZ04	24203100	EL, 10 $\mu$ F, $\pm$ 20%, 16V
CZ05	24232103	CD, 0.01 $\mu$ F, +80%, -20%
CZ06	24436680	CD, 68pF
CZ07	24794101	EL, 100 $\mu$ F, $\pm$ 20%, 16V

#### RESISTORS

R173	24366102	CF, 1k ohm
R181	24366131	CF, 130 ohm
R182	24366680	CF, 68 ohm
R183	24366682	CF, 6800 ohm
R184	24366332	CF, 3300 ohm
R185	24366271	CF, 270 ohm
R186	24366223	CF, 22k ohm
R187	24366331	CF, 330 ohm
R206	24366471	CF, 470 ohm
R208	24366101	CF, 100 ohm
R209	24366103	CF, 10k ohm
R210	24366203	CF, 20k ohm
R211	24366622	CF, 6200 ohm

Location No.	Part No.	Description
R212	24366103	CF, 10k ohm
R213	24366101	CF, 100 ohm
R214	24366222	CF, 2200 ohm
R215	24366222	CF, 2200 ohm
R216	24366133	CF, 13k ohm
R217	24366101	CF, 100 ohm
R218	24366222	CF, 2200 ohm
R219	24366472	CF, 4700 ohm
R223	24366432	CF, 4300 ohm
R224	24366331	CF, 330 ohm
R226	24366362	CF, 3600 ohm
R227	24366102	CF, 1k ohm
R228	24366822	CF, 8200 ohm
R229	24366821	CF, 820 ohm
R230	24366821	CF, 820 ohm
R231	24366821	CF, 820 ohm
R240	24366153	CF, 15k ohm
R241	24366682	CF, 6800 ohm
R242	24552101	OMF, 100 ohm, 1/2W
R243	24366201	CF, 200 ohm
R244	24366102	CF, 1k ohm
R247	24366121	CF, 120 ohm
R252	24066596	VR, 500 ohm, 1/10W
R253	24066596	VR, 500 ohm, 1/10W
R255	24066926	VR, 10k ohm, 1/10W
R301	24366301	CF, 300 ohm
R302	24366244	CF, 240k ohm
R303	24366393	CF, 39k ohm
R304	24366102	CF, 1k ohm
R305	24366161	CF, 160 ohm
R306	24366203	CF, 20k ohm
R307	24366101	CF, 100 ohm
R308	24366561	CF, 560 ohm
R311	24552242	OMF, 2400 ohm, 1/2W
R312	24366103	CF, 10k ohm
R313	24366184	CF, 180k ohm
R318	24366102	CF, 1k ohm
R320	24366471	CF, 470 ohm
R322	24552472	OMF, 4700 ohm, 1/2W
R323	24323828	OMF, 0.82 ohm, 2W
R325	24366123	CF, 12k ohm
R327	24983479	MF, 4.7 ohm, 1W
R328	24552111	OMF, 110 ohm, 1/2W
R329	24366123	CF, 12k ohm
R331	24366473	CF, 47k ohm
R332	24553122	OMF, 1200 ohm, 1W
R333	24366913	CF, 91k ohm
R334	24366103	CF, 10k ohm
R335	24366823	CF, 82k ohm
R337	24553122	OMF, 1200 ohm, 1W
R340	24366472	CF, 4700 ohm
R341	24366103	CF, 10k ohm
R351	24066924	VR, 50k ohm, 1/10W
R386	24366102	CF, 1k ohm
R387	24366103	CF, 10k ohm
R401	24366472	CF, 4700 ohm
R402	24366273	CF, 27k ohm
R403	24366302	CF, 3k ohm
R405	24366511	CF, 510 ohm
R406	24366271	CF, 270 ohm
R407	24366151	CF, 150 ohm
R408	24366562	CF, 5600 ohm
R409	24366103	CF, 10k ohm
R410	24552432	OMF, 4300 ohm, 1/2W

Location No.	Part No.	Description
R411	24366431	CF, 430 ohm
R412	24366151	CF, 150 ohm
R417	24007642	Cement, 5600 ohm, 5W
R418	24553682	OMF, 6800 ohm, 1W
R420	24366104	CF, 100k ohm
R440	24366103	CF, 10k ohm
R441	24366103	CF, 10k ohm
R443	24322109	OMF, 1 ohm, 1W
R444	24994828	MF, 0.82 ohm, $\pm 10\%$ , 2W
R448	24323189	OMF, 1.8 ohm, 2W
R451	24066951	VR, 20k ohm, 1/10W
R460	24552161	OMF, 160 ohm, 1/2W
R463	24553102	OMF, 1k ohm, 1W
R464	24366683	CF, 68k ohm
R465	24366433	CF, 43k ohm
R466	24366912	CF, 9100 ohm
R467	24366272	CF, 2700 ohm
R468	24366102	CF, 1k ohm
R471	24533151	FR, 150 ohm, 2W
R502	24366334	CF, 330k ohm
R503	24366202	CF, 2k ohm
R504	24366471	CF, 470 ohm
R505	24366822	CF, 8200 ohm
R506	24366821	CF, 820 ohm
R507	24366822	CF, 8200 ohm
R508	24366821	CF, 820 ohm
R509	24366203	CF, 20k ohm
R510	24366101	CF, 100 ohm
R511	24366562	CF, 5600 ohm
R512	24366152	CF, 1500 ohm
R513	24366152	CF, 1500 ohm
R515	24366221	CF, 220 ohm
R516	24366221	CF, 220 ohm
R517	24366221	CF, 220 ohm
R518	24945475	CC, 4.7M ohm, $\pm 10\%$ , 1/4W
R519	24366103	CF, 10k ohm
R520	24366332	CF, 3300 ohm
R521	24366102	CF, 1k ohm
R522	24360185	CF, 1.8M ohm, 1/8W
R525	24366122	CF, 1200 ohm
R526	24366122	CF, 1200 ohm
R527	24366103	CF, 10k ohm
R528	24366103	CF, 10k ohm
R531	24366161	CF, 160 ohm
R532	24366361	CF, 360 ohm
R533	24366362	CF, 3600 ohm
R535	24366361	CF, 360 ohm
R537	24366362	CF, 3600 ohm
R538	24366391	CF, 390 ohm
R539	24366362	CF, 3600 ohm
R541	24366821	CF, 820 ohm
R542	24366241	CF, 240 ohm
R543	24366103	CF, 10k ohm
R544	24366101	CF, 100 ohm
R547	24366102	CF, 1k ohm
R548	24366102	CF, 1k ohm
R549	24366102	CF, 1k ohm
R551	24066955	VR, 1k ohm, 1/10W
R557	24066600	VR, 10k ohm, 1/10W
R558	24066600	VR, 10k ohm, 1/10W
R559	24066600	VR, 10k ohm, 1/10W
R565	24366560	CF, 56 ohm
R566	24366560	CF, 56 ohm
R567	24366560	CF, 56 ohm

Location No.	Part No.	Description
R568	24366102	CF, 1k ohm
R570	24366302	CF, 3k ohm
R571	24366302	CF, 3k ohm
R572	24366302	CF, 3k ohm
R576	24366472	CF, 4700 ohm
R577	24366472	CF, 4700 ohm
R578	24366101	CF, 100 ohm
R579	24366103	CF, 10k ohm
R580	24366101	CF, 100 ohm
R581	24366103	CF, 10k ohm
R591	24383153	OMF, 15k ohm, 2W
R592	24383153	OMF, 15k ohm, 2W
R593	24383153	OMF, 15k ohm, 2W
R603	24366101	CF, 100 ohm
R604	24366332	CF, 3300 ohm
R605	24366101	CF, 100 ohm
R606	24366332	CF, 3300 ohm
R620	24366102	CF, 1k ohm
R621	24366103	CF, 10k ohm
R622	24366103	CF, 10k ohm
R623	24366472	CF, 4700 ohm
R624	24366154	CF, 150k ohm
R625	24366154	CF, 150k ohm
R626	24366102	CF, 1k ohm
R627	24366102	CF, 1k ohm
R628	24366103	CF, 10k ohm
R629	24366244	CF, 240k ohm
R630	24366472	CF, 4700 ohm
R631	24366153	CF, 15k ohm
R632	24366562	CF, 5600 ohm
R633	24366562	CF, 5600 ohm
R634	24366153	CF, 15k ohm
R635	24366472	CF, 4700 ohm
R636	24366222	CF, 2200 ohm
R637	24366222	CF, 2200 ohm
R638	24366682	CF, 6800 ohm
R639	24366472	CF, 4700 ohm
R640	24366473	CF, 47k ohm
R641	24366473	CF, 47k ohm
R642	24366472	CF, 4700 ohm
R643	24366682	CF, 6800 ohm
R644	24366229	CF, 2.2 ohm
R645	24366229	CF, 2.2 ohm
R646	24366102	CF, 1k ohm
R665	24552331	OMF, 330 ohm, 1/2W
R666	24552331	OMF, 330 ohm, 1/2W
R667	24366103	CF, 10k ohm
R668	24366103	CF, 10k ohm
R669	24366334	CF, 330k ohm
R670	24366821	CF, 820 ohm
R671	24366272	CF, 2700 ohm
R672	24366152	CF, 1500 ohm
R673	24366472	CF, 4700 ohm
R674	24366471	CF, 470 ohm
R675	24366122	CF, 1200 ohm
R676	24366105	CF, 1M ohm
R677	24552331	OMF, 330 ohm, 1/2W
R678	24366152	CF, 1500 ohm
R679	24366473	CF, 47k ohm
R680	24366104	CF, 100k ohm
R681	24366102	CF, 1k ohm
R682	24366182	CF, 1800 ohm
R683	24366472	CF, 4700 ohm
R684	24366182	CF, 1800 ohm

Location No.	Part No.	Description
R685	24366153	CF, 15k ohm
R686	24366101	CF, 100 ohm
R687	24366562	CF, 5600 ohm
R688	24366221	CF, 220 ohm
R689	24366102	CF, 1k ohm
R690	24366471	CF, 470 ohm
R691	24366223	CF, 22k ohm
R692	24552680	OMF, 68 ohm, 1/2W
R693	24366103	CF, 10k ohm
R694	24366752	CF, 7500 ohm
R695	24366103	CF, 10k ohm
R696	24366472	CF, 4700 ohm
R697	24366103	CF, 10k ohm
R698	24366103	CF, 10k ohm
R801	24942565	CC, 5.6M ohm, 1/2W
R802	24522390	Cement, 39 ohm, $\pm 10\%$ , 2W
R803	24007870	Cement, 1.5 ohm, 15W
R804	24366331	CF, 330 ohm
R805	24007870	Cement, 1.5 ohm, 15W
R806	24383333	OMF, 33k ohm, 2W
R807	24383333	OMF, 33k ohm, 2W
R808	24366362	CF, 3600 ohm
R810	24384823	OMF, 82k ohm, 3W
R812	24321689	OMF, 6.8 ohm, 1/2W
R813	24553471	OMF, 470 ohm, 1W
R814	24321338	OMF, 0.33 ohm, 1/2W
R815	24366683	CF, 68k ohm
R816	24367123	CF, 12k ohm, $\pm 2\%$
R817	24007952	Cement, 6.8 ohm, 5W
R818	24366331	CF, 330 ohm
R819	24327104	MF, 100k ohm, $\pm 1\%$ , 1/4W
R820	24366100	CF, 10 ohm
R821	24366101	CF, 100 ohm
R822	24322398	OMF, 0.39 ohm, 1W
R823	24007738	Cement, 330 ohm, 10W
R824	24322398	OMF, 0.39 ohm, 1W
R825	24366101	CF, 100 ohm
R826	24366331	CF, 330 ohm
R827	24007568	Cement, 1800 ohm, 5W
R828	24366103	CF, 10k ohm
R829	24383103	OMF, 10k ohm, 2W
R830	24552391	OMF, 390 ohm, 1/2W
R831	24366102	CF, 1k ohm
R832	24321338	OMF, 0.33 ohm, 1/2W
R833	24327134	MF, 130k ohm, $\pm 1\%$ , 1/4W
R834	24327222	MF, 2200 ohm, $\pm 1\%$ , 1/4W
R835	24366823	CF, 82k ohm
R836	24327913	MF, 91k ohm, $\pm 1\%$ , 1/4W
R837	24381100	OMF, 10 ohm, 1/2W
R838	24366103	CF, 10k ohm
R840	24366103	CF, 10k ohm
R841	24381562	OMF, 5600 ohm, 1/2W
R843	24366332	CF, 3300 ohm
R844	24366103	CF, 10k ohm
R845	24366332	CF, 3300 ohm
R847	24366102	CF, 1k ohm
R851	24066924	VR, 50k ohm, 1/10W
R852	24066925	VR, 20k ohm, 1/10W
R860	24366182	CF, 1800 ohm
R861	24982338	MF, 0.33 ohm, 1/2W
R863	24383152	OMF, 1500 ohm, 2W
R865	24366222	CF, 2200 ohm
R867	24366392	CF, 3900 ohm
R868	24366103	CF, 10k ohm



Location No.	Part No.	Description
R869	24366102	CF, 1k ohm
R870	24366102	CF, 1k ohm
R871	24366222	CF, 2200 ohm
R872	24366103	CF, 10k ohm
R890	24000875	PTC Thermistor, 18 ohm, ±20%, 290V
R901	24946272	CC, 2700 ohm, ±10%, 1/2W
R902	24946272	CC, 2700 ohm, ±10%, 1/2W
R903	24946272	CC, 2700 ohm, ±10%, 1/2W
△ R920	24000880	FR, 5.1 ohm, 1W
RA01	24366472	CF, 4700 ohm
RA02	24366102	CF, 1k ohm
RA03	24366101	CF, 100 ohm
RA05	24366102	CF, 1k ohm
RA06	24366102	CF, 1k ohm
RA07	24366102	CF, 1k ohm
RA08	24366102	CF, 1k ohm
RA09	24366102	CF, 1k ohm
RA10	24366102	CF, 1k ohm
RA11	24366102	CF, 1k ohm
RA12	24366102	CF, 1k ohm
RA13	24366102	CF, 1k ohm
RA14	24366103	CF, 10k ohm
RA15	24366102	CF, 1k ohm
RA16	24366102	CF, 1k ohm
RA17	24366102	CF, 1k ohm
RA18	24366102	CF, 1k ohm
RA19	24366102	CF, 1k ohm
RA20	24366123	CF, 12k ohm
RA21	24366102	CF, 1k ohm
RA22	24366102	CF, 1k ohm
RA23	24366102	CF, 1k ohm
RA24	24366471	CF, 470 ohm
RA25	24366102	CF, 1k ohm
RA26	24366102	CF, 1k ohm
RA27	24366102	CF, 1k ohm
RA28	24366103	CF, 10k ohm
RA29	24366102	CF, 1k ohm
RA30	24366223	CF, 22k ohm
RA31	24366102	CF, 1k ohm
RA32	24366102	CF, 1k ohm
RA33	24366471	CF, 470 ohm
RA34	24366101	CF, 100 ohm
RA35	24366473	CF, 47k ohm
RA36	24366221	CF, 220 ohm
RA37	24366563	CF, 56k ohm
RA38	24366333	CF, 33k ohm
RA39	24366223	CF, 22k ohm
RA41	24366103	CF, 10k ohm
RA42	24366102	CF, 1k ohm
RA46	24366202	CF, 2k ohm
RA47	24366392	CF, 3900 ohm
RA48	24366432	CF, 4300 ohm
RA49	24366432	CF, 4300 ohm
RA53	24366102	CF, 1k ohm
RA54	24366223	CF, 22k ohm
RA55	24366333	CF, 33k ohm
RA56	24366333	CF, 33k ohm
RA57	24366333	CF, 33k ohm
RA58	24366221	CF, 220 ohm
RA60	24366333	CF, 33k ohm
RA61	24366392	CF, 3900 ohm
RA64	24383510	OMF, 51 ohm, 2W
RA65	24366103	CF, 10k ohm

Location No.	Part No.	Description
RA66	24366103	CF, 10k ohm
RA68	24366472	CF, 4700 ohm
RA69	24366392	CF, 3900 ohm
RA70	24366472	CF, 4700 ohm
RA76	24366153	CF, 15k ohm
RA83	24366431	CF, 430 ohm
RA87	24366333	CF, 33k ohm
RA88	24366431	CF, 430 ohm
RA89	24366563	CF, 56k ohm
RA90	24366564	CF, 560k ohm
RA91	24366561	CF, 560 ohm
RA92	24366102	CF, 1k ohm
RA93	24366123	CF, 12k ohm
RB01	24366472	CF, 4700 ohm
RB02	24366302	CF, 3k ohm
RB04	24366103	CF, 10k ohm
RB05	24366332	CF, 3300 ohm
RB06	24366473	CF, 47k ohm
RB12	24366102	CF, 1k ohm
RB14	24366102	CF, 1k ohm
RB15	24366102	CF, 1k ohm
RB22	24366183	CF, 18k ohm
RB25	24945565	CC, 5.6M ohm, ±10%, 1/4W
RB26	24945565	CC, 5.6M ohm, ±10%, 1/4W
RB27	24945565	CC, 5.6M ohm, ±10%, 1/4W
RB28	24945565	CC, 5.6M ohm, ±10%, 1/4W
RD01	24000665	FR, 15 ohm, 1/4W
RD02	24383100	OMF, 10 ohm, 2W
RD03	24366562	CF, 5600 ohm
RD05	24003924	MF, 330 ohm, 1/4W
RD06	24366272	CF, 2700 ohm
RD07	24366104	CF, 100k ohm
RD08	24366203	CF, 20k ohm
RD09	24366152	CF, 1500 ohm
RD10	24366102	CF, 1k ohm
RD11	24366224	CF, 220k ohm
RD12	24366822	CF, 8200 ohm
RD13	24366273	CF, 27k ohm
RD14	24366103	CF, 10k ohm
RD15	24366104	CF, 100k ohm
RD16	24366752	CF, 7500 ohm
RD17	24366223	CF, 22k ohm
RD18	24366472	CF, 4700 ohm
RD19	24366242	CF, 2400 ohm
RD50	24066877	VR, 5k ohm, 0.3W
RD51	24066875	VR, 20k ohm, 0.3W
RM03	24366182	CF, 1800 ohm
RM04	24366242	CF, 2400 ohm
RM05	24366151	CF, 150 ohm
RM06	24945475	CC, 4.7M ohm, ±10%, 1/4W
RM26	24366333	CF, 33k ohm
RN05	24366222	CF, 2200 ohm
RN12	24366122	CF, 1200 ohm
RN13	24366103	CF, 10k ohm
RN14	24366103	CF, 10k ohm
RN15	24366223	CF, 22k ohm
RN16	24366333	CF, 33k ohm
RN17	24366471	CF, 470 ohm
RN18	24366201	CF, 200 ohm
RN19	24366182	CF, 1800 ohm
RN21	24366102	CF, 1k ohm
RN22	24366333	CF, 33k ohm
RN24	24366103	CF, 10k ohm
RN25	24366304	CF, 300k ohm

Location No.	Part No.	Description
RN26	24366103	CF, 10k ohm
RN28	24366514	CF, 510k ohm
RN29	24366473	CF, 47k ohm
RN30	24366473	CF, 47k ohm
RN31	24366103	CF, 10k ohm
RN32	24366392	CF, 3900 ohm
RN33	24366132	CF, 1300 ohm
RN34	24366273	CF, 27k ohm
RN40	24366821	CF, 820 ohm
RN41	24366103	CF, 10k ohm
RN42	24366103	CF, 10k ohm
RN43	24366222	CF, 2200 ohm
RN44	24366331	CF, 330 ohm
RS03	24366103	CF, 10k ohm
RS04	24366103	CF, 10k ohm
RS05	24366103	CF, 10k ohm
RS06	24366102	CF, 1k ohm
RS07	24366103	CF, 10k ohm
RS08	24366103	CF, 10k ohm
RS09	24366103	CF, 10k ohm
RS10	24366103	CF, 10k ohm
RS11	24366153	CF, 15k ohm
RS12	24366103	CF, 10k ohm
RS13	24366103	CF, 10k ohm
RS14	24366103	CF, 10k ohm
RS15	24366103	CF, 10k ohm
RS16	24366103	CF, 10k ohm
RS17	24366222	CF, 2200 ohm
RS18	24366103	CF, 10k ohm
RS19	24366103	CF, 10k ohm
RS20	24366473	CF, 47k ohm
RS21	24366473	CF, 47k ohm
RS22	24366223	CF, 22k ohm
RS23	24366473	CF, 47k ohm
RS24	24366473	CF, 47k ohm
RS25	24552101	OMF, 100 ohm, 1/2W
RS26	24366223	CF, 22k ohm
RS27	24366273	CF, 27k ohm
RS28	24366103	CF, 10k ohm
RS29	24366222	CF, 2200 ohm
RS30	24366222	CF, 2200 ohm
RS31	24366222	CF, 2200 ohm
RS32	24366103	CF, 10k ohm
RS33	24366103	CF, 10k ohm
RS34	24366134	CF, 130k ohm
RV03	24366101	CF, 100 ohm
RV04	24366102	CF, 1k ohm
RV05	24366103	CF, 10k ohm
RV06	24366101	CF, 100 ohm
RV12	24366101	CF, 100 ohm
RV13	24366473	CF, 47k ohm
RV15	24366223	CF, 22k ohm
RV16	24366223	CF, 22k ohm
RV17	24366102	CF, 1k ohm
RV18	24366473	CF, 47k ohm
RV19	24366104	CF, 100k ohm
RV21	24366102	CF, 1k ohm
RV22	24366681	CF, 680 ohm
RV24	24366222	CF, 2200 ohm
RV25	24366222	CF, 2200 ohm
RV26	24366102	CF, 1k ohm
RV27	24366473	CF, 47k ohm
RV28	24366103	CF, 10k ohm
RV29	24366103	CF, 10k ohm

Location No.	Part No.	Description
RV30	24366223	CF, 22k ohm
RV31	24366101	CF, 100 ohm
RV32	24366332	CF, 3300 ohm
RV33	24366332	CF, 3300 ohm
RV34	24552750	OMF, 75 ohm, 1/2W
RV35	24366101	CF, 100 ohm
RV36	24366102	CF, 1k ohm
RV37	24366103	CF, 10k ohm
RV38	24366473	CF, 47k ohm
RV39	24366473	CF, 47k ohm
RV40	24366102	CF, 1k ohm
RV41	24366102	CF, 1k ohm
RV42	24366223	CF, 22k ohm
RV43	24366223	CF, 22k ohm
RV44	24366103	CF, 10k ohm
RV45	24366820	CF, 82 ohm
RV46	24366820	CF, 82 ohm
RV66	24366910	CF, 91 ohm
RV68	24366473	CF, 47k ohm
RV69	24366102	CF, 1k ohm
RV70	24366473	CF, 47k ohm
RV71	24366102	CF, 1k ohm
RV72	24366103	CF, 10k ohm
RV73	24366180	CF, 18 ohm
RV74	24366473	CF, 47k ohm
RV75	24366102	CF, 1k ohm
RV76	24366473	CF, 47k ohm
RV77	24366102	CF, 1k ohm
RV78	24366102	CF, 1k ohm
RV79	24366102	CF, 1k ohm
RX03	24366103	CF, 10k ohm
RX05	24366101	CF, 100 ohm
RX06	24366681	CF, 680 ohm
RX09	24366681	CF, 680 ohm
RX13	24366102	CF, 1k ohm
RX16	24366152	CF, 1500 ohm
RX17	24366152	CF, 1500 ohm
RX18	24366683	CF, 68k ohm
RX19	24366222	CF, 2200 ohm
RX20	24366473	CF, 47k ohm
RX27	24366103	CF, 10k ohm
RX29	24366103	CF, 10k ohm
RX31	24366103	CF, 10k ohm
RX32	24366103	CF, 10k ohm
RX33	24366473	CF, 47k ohm
RX34	24366224	CF, 220k ohm
RX35	24366473	CF, 47k ohm
RX36	24366101	CF, 100 ohm
RX37	24366273	CF, 27k ohm
RX38	24366473	CF, 47k ohm
RX39	24366102	CF, 1k ohm
RX40	24366102	CF, 1k ohm
RZ01	24366112	CF, 1100 ohm
RZ02	24366122	CF, 1200 ohm
RZ03	24366332	CF, 3300 ohm
RZ04	24366103	CF, 10k ohm
RZ05	24366222	CF, 2200 ohm
RZ06	24366101	CF, 100 ohm
RZ08	24366102	CF, 1k ohm
RZ09	24366103	CF, 10k ohm
RZ10	24366103	CF, 10k ohm
RZ11	24366471	CF, 470 ohm
RZ13	24366104	CF, 100k ohm
RZ14	24366102	CF, 1k ohm

Location No.	Part No.	Description
RZ15	24366471	CF, 470 ohm
<b>COILS &amp; TRANSFORMERS</b>		
L181	23261985	Coil, RF Choke, TRF9221
L203	23238914	Coil, Peaking, TRF4470AC
L241	23238923	Coil, Peaking, TRF4829AC
L270	23238928	Coil, Peaking, TRF4339AC
L311	23261974	Coil, Choke, HC5-035
L410	23238710	Coil, Peaking, TRF4220AJ
L411	23103859	Coil (Ferrite Bead), TEM2011
L412	23103859	Coil (Ferrite Bead), TEM2011
L413	23233089	Coil, Linearity, TLN2137
△ L462	23227269	Deflection Yoke, TDY-628DB
L463	23221684	Coil, Choke, TLN3191D
L465	23221894	Coil, Choke, TLN3063
L503	23238922	Coil, Peaking, TRF4100AC
L551	23250972	Coil, 1H-Delay Matching, TRF5418D
L580	23238562	Coil, Peaking, TRF4109AJ
L590	23237978	Coil, Peaking, TRF4560AC
L593	70131039	Coil, Signal Line, ZBF503D-00
L671	23262739	Coil, IF, TRF1126D
L672	23262739	Coil, IF, TRF1126D
L673	23238918	Coil, Peaking, TRF4220AC
L674	23232946	Coil, Variable, TRF3073D
L675	23238511	Coil, Peaking, TRF4221AJ
L802	23221076	Coil, Choke, TLN1015R
L803	23261975	Coil, Choke, TRF9229
L804	23261975	Coil, Choke, TRF9229
L805	23222694	Coil, Width, TLN2026
L806	23103859	Coil (Ferrite Bead), TEM2011
L808	23222694	Coil, Width, TLN2026
L810	23222694	Coil, Width, TLN2026
L811	23103859	Coil (Ferrite Bead), TEM2011
L812	23238714	Coil, Peaking, TRF4100AJ
L813	23103859	Coil (Ferrite Bead), TEM2011
L814	23103859	Coil (Ferrite Bead), TEM2011
△ L901	23200755	Coil, Degaussing, TSB2206A
LA01	23238562	Coil, Peaking, TRF4109AJ
LA03	23221937	Coil, Choke, TLN3040
LB01	23262778	Coil, IF, TRF1112
LD02	23221885	Coil, Choke, TLN3072
LD03	23103940	Coil (Ferrite Bead), TEM2001
LM01	23262797	Coil, IF, TRF1093D
LM02	23250865	Coil, IF, TRF5414DA
LM03	23250865	Coil, IF, TRF5414DA
LM04	23262798	Coil, IF, TRF1092D
LN02	23238920	Coil, Peaking, TRF4150AC
LN03	23238918	Coil, Peaking, TRF4220AC
LN40	23238921	Coil, Peaking, TRF4120AC
LN41	23237986	Coil, Peaking, TRF4120AC
LV02	23238918	Coil, Peaking, TRF4220AC
LZ01	23238923	Coil, Peaking, TRF4829AC
T181	23262895	Coil, PIF Trap, TRF1441
T182	23262843	Coil, PIF Trap, TRF1457D
△ T401	23224915	Transformer, Horiz. Drive, TLN1068
△ T461	23236234	Transformer, Flyback, TFB4092AD
T801	23211857	Line Filter, TRF3138
T802	23211857	Line Filter, TRF3138
△ T803	23213506	Transformer, Converter, TPW3152A

Location No.	Part No.	Description
T804	23224917	Transformer, Separation, TLN2122
<b>SEMICONDUCTORS</b>		
IC303	23119142	IC, AN5521
IC405	23318218	IC, $\mu$ PC7812H
IC501	B0379470	IC, TA8659N
IC604	B0356190	IC, TA7630P
IC605	B0376856	IC, TA8211AH
IC670	B0379150	IC, TA8615N
IC674	B0325290	IC, TA7337P
IC803	23318411	IC, TEA2164
IC806	23318299	IC, L78MR05-FA
IC807	23318412	IC, TEA5170
ICA01	23318445	IC, M50436-688SP
ICA02	23119182	IC, $\mu$ PD6336C
ICA03	23318482	IC, M6M80011AP
ICA04	23119441	IC, LA7910
ICS02	B0350000	IC, TA75458P
ICS03	B0350000	IC, TA75458P
ICV01	B0383505	IC, TA8720AN
ICZ01	B0470532	IC, TC40538P
Q171	A6317440	Transistor, 2SC1815N-Y
Q181	A6708871	Transistor, 2SC388ATM
Q204	A6317440	Transistor, 2SC1815N-Y
Q205	A6317440	Transistor, 2SC1815N-Y
Q240	A6534040	Transistor, 2SA1015-Y
Q241	A6319300	Transistor, 2SC1959N-Y
Q301	A6317480	Transistor, 2SC1815N-BL
Q302	A6317440	Transistor, 2SC1815N-Y
Q304	A6317440	Transistor, 2SC1815N-Y
Q305	A6317440	Transistor, 2SC1815N-Y
Q402	A678971D	Transistor, 2SC1569 FA-5
△ Q404	A6872801	Transistor, 2SD2253
Q406	A6317440	Transistor, 2SC1815N-Y
Q502	A6534040	Transistor, 2SA1015-Y
Q503	A6534040	Transistor, 2SA1015-Y
Q505	A6363200	Transistor, 2SC3619
Q506	A6317440	Transistor, 2SC1815N-Y
Q507	A6363200	Transistor, 2SC3619
Q508	A6317440	Transistor, 2SC1815N-Y
Q509	A6363200	Transistor, 2SC3619
Q510	A6317440	Transistor, 2SC1815N-Y
Q514	A6509120	Transistor, 2SA562TM-O
Q516	A6321240	Transistor, 2SC2120-Y
Q570	A6317460	Transistor, 2SC1815-GR
Q601	A6534040	Transistor, 2SA1015-Y
Q602	A6342200	Transistor, 2SC2878-A
Q603	A6342200	Transistor, 2SC2878-A
Q606	A6317440	Transistor, 2SC1815N-Y
Q607	A6317440	Transistor, 2SC1815N-Y
Q608	A6317440	Transistor, 2SC1815N-Y
Q609	A6317440	Transistor, 2SC1815N-Y
Q671	A6317440	Transistor, 2SC1815N-Y
Q672	A6317440	Transistor, 2SC1815N-Y
Q673	A6509140	Transistor, 2SA562TMY
Q675	A6317440	Transistor, 2SC1815N-Y
Q681	A6317440	Transistor, 2SC1815N-Y
Q801	23314519	Transistor (STR), STR81145L501
Q804	A6366908	Transistor, 2SC4288A FA-1
Q805	A6533749	Transistor, 2SA1013-R(C)
Q808	A7804500	SCR, SF5J42
Q809	A6317440	Transistor, 2SC1815N-Y

Location No.	Part No.	Description
Q810	A6328333	Transistor, 2SC2383-Y(C)
Q811	A6534040	Transistor, 2SA1015-Y
Q814	A6546310	Transistor, 2SA1297Y
Q815	A6317440	Transistor, 2SC1815N-Y
Q816	A6867980	Transistor, 2SD1405-V
Q817	A6321240	Transistor, 2SC2120-Y
QA05	A6534040	Transistor, 2SA1015-Y
QA14	A6317440	Transistor, 2SC1815N-Y
QA17	A6317440	Transistor, 2SC1815N-Y
QA19	A6317440	Transistor, 2SC1815N-Y
QA22	A6534040	Transistor, 2SA1015-Y
QA26	A6534040	Transistor, 2SA1015-Y
QB01	A6317440	Transistor, 2SC1815N-Y
QB02	A6317440	Transistor, 2SC1815N-Y
QD01	A6533730	Transistor, 2SA1012-Y
QD02	23114528	Transistor, 2SC1740S-Q
QD03	23114530	Transistor, 2SA933S-Q
QD04	A6342200	Transistor, 2SC2878-A
QN01	A6002060	Transistor, RN1206
QN02	A6534040	Transistor, 2SA1015-Y
QN03	A6534040	Transistor, 2SA1015-Y
QN04	A6317440	Transistor, 2SC1815N-Y
QN05	A6317440	Transistor, 2SC1815N-Y
QN06	A6002040	Transistor, RN1204
QN07	A6317440	Transistor, 2SC1815N-Y
QN08	A6002040	Transistor, RN1204
QN09	A6317440	Transistor, 2SC1815N-Y
QN10	A6317440	Transistor, 2SC1815N-Y
QN11	A6002040	Transistor, RN1204
QN40	A6317440	Transistor, 2SC1815N-Y
QS04	A6317440	Transistor, 2SC1815N-Y
QS05	A6342200	Transistor, 2SC2878-A
QS06	A6317440	Transistor, 2SC1815N-Y
QS07	A6317440	Transistor, 2SC1815N-Y
QS08	A6317440	Transistor, 2SC1815N-Y
QV02	A6002040	Transistor, RN1204
QV03	A6342200	Transistor, 2SC2878-A
QV04	A6534040	Transistor, 2SA1015-Y
QV05	A6317440	Transistor, 2SC1815N-Y
QV06	A6534040	Transistor, 2SA1015-Y
QV07	A6342200	Transistor, 2SC2878-A
QV08	A6317440	Transistor, 2SC1815N-Y
QX01	A6317440	Transistor, 2SC1815N-Y
QX02	A6734585	Transistor, 2SC752GTM-O
QX06	A6534040	Transistor, 2SA1015-Y
QX07	A6317440	Transistor, 2SC1815N-Y
QX08	A6002040	Transistor, RN1204
QX09	A6002060	Transistor, RN1206
QZ02	A6534040	Transistor, 2SA1015-Y
QZ03	A6342200	Transistor, 2SC2878-A
D181	A7288601	Diode, 1S2186 FA-1
D182	A7288601	Diode, 1S2186 FA-1
D183	A7288601	Diode, 1S2186 FA-1
D241	A7150041	Diode, 1SS104
D302	A7568250	Diode, 1S1834
D303	23118977	Diode, ERC01-02FL
D315	A7116715	Diode, Zener, 04AZ7.5Y
D317	A7150258	Diode, 1SS176
D320	A7150258	Diode, 1SS176
D321	A7150258	Diode, 1SS176
D340	A7150258	Diode, 1SS176
D401	A7116925	Diode, Zener, 04AZ9.1Z
D402	A7117215	Diode, Zener, 04AZ12Y
D405	A7117715	Diode, Zener, 04AZ20Y

Location No.	Part No.	Description
D406	A7978850	Diode, S5295G
D408	23118052	Diode, RU4Z
D410	A7116815	Diode, Zener, 04AZ8.2Y
D570	A7150258	Diode, 1SS176
D571	A7150258	Diode, 1SS176
D572	A7150258	Diode, 1SS176
D573	A7150258	Diode, 1SS176
D580	A7150258	Diode, 1SS176
D581	A7150258	Diode, 1SS176
D582	A7150258	Diode, 1SS176
D594	A7150258	Diode, 1SS176
D595	A7150258	Diode, 1SS176
D596	A7150258	Diode, 1SS176
D601	A7150258	Diode, 1SS176
D602	A7150258	Diode, 1SS176
D603	A7150258	Diode, 1SS176
D604	A7150258	Diode, 1SS176
D605	A7150258	Diode, 1SS176
D606	A7150258	Diode, 1SS176
D607	A7150258	Diode, 1SS176
D608	A7150258	Diode, 1SS176
D609	A7150258	Diode, 1SS176
D610	A7150258	Diode, 1SS176
D670	A7150258	Diode, 1SS176
D671	A7150258	Diode, 1SS176
D672	A7150258	Diode, 1SS176
D673	A7288601	Diode, 1S2186 FA-1
D674	A7150258	Diode, 1SS176
D675	A7150258	Diode, 1SS176
D676	A7150258	Diode, 1SS176
D801	A7568200	Diode, 1S1832
D802	A7568200	Diode, 1S1832
D803	23316275	Diode, RBV606 LF-A
D804	A7117815	Diode, Zener, 04AZ22Y
D807	A7978850	Diode, S5295G
D808	A7978850	Diode, S5295G
D809	A7978850	Diode, S5295G
D810	A7568300	Diode, 1S1835
D811	A7117415	Diode, Zener, 04AZ15Y
D812	A7978850	Diode, S5295G
D813	A7978850	Diode, S5295G
D814	A7978850	Diode, S5295G
D815	A7978850	Diode, S5295G
D816	A7978850	Diode, S5295G
D817	23118451	Diode, RU4A
D818	23118338	Diode, RU4AM
D819	A7568300	Diode, 1S1835
D820	A7116615	Diode, Zener, 04AZ6.8Y
D821	A7150258	Diode, 1SS176
D822	A7275400	Diode, 1S2462
D824	A7150258	Diode, 1SS176
D826	A7568300	Diode, 1S1835
D828	23118052	Diode, RU4Z
D830	A7150258	Diode, 1SS176
D832	A7116615	Diode, Zener, 04AZ6.8Y
D833	A7978850	Diode, S5295G
D834	A7116615	Diode, Zener, 04AZ6.8Y
D841	A7116415	Diode, Zener, 04AZ5.6Y
DA01	A7150258	Diode, 1SS176
DA02	A7150258	Diode, 1SS176
DA03	A7150258	Diode, 1SS176
DA04	A7150258	Diode, 1SS176
DA05	A7150258	Diode, 1SS176
DA06	A7150258	Diode, 1SS176

Location No.	Part No.	Description
DA08	A7150258	Diode, 1SS176
DA09	A7150258	Diode, 1SS176
DA10	23115878	Diode, Zener, $\mu$ PC574J(L)
DA11	A7150258	Diode, 1SS176
DA12	A7150258	Diode, 1SS176
DA14	A7150258	Diode, 1SS176
DA15	A7150258	Diode, 1SS176
DA16	A7150258	Diode, 1SS176
DA20	A7150258	Diode, 1SS176
DA55	A8606431	Diode (LED), TLG153, Green
DB10	A7150258	Diode, 1SS176
DD01	A7568460	Diode, TVR-1B
DD02	23118943	Diode, ERC20-04
DD03	A7568752	Diode, 1S1887A
DD04	A7150258	Diode, 1SS176
DD05	A7150258	Diode, 1SS176
DD06	A7150258	Diode, 1SS176
DE55	A8636541	Diode (LED), TLS153, Red
DN06	A7288601	Diode, 1S2186 FA-1
DN07	A7288601	Diode, 1S2186 FA-1
DS55	A8608781	Diode (LED), TLY153, Yellow
DV01	A7150258	Diode, 1SS176
DV03	A7150258	Diode, 1SS176
DV05	A7116915	Diode, Zener, 04AZ9.1Y
DV06	A7150258	Diode, 1SS176
DX03	A7150258	Diode, 1SS176
DX04	A7150258	Diode, 1SS176
<b>MISCELLANEOUS</b>		
△ F801	23144867	Fuse, 4.0A
F801A	23165102	Fuse Holder
K901	23120303	Remote Sensor, IR-9109-K
L462A	23993726	Compensator, DY, YH
L462B	23993622	Compensator, DY, TC-M
P003	23161701	Terminal, 4P
P270	23845834	Clamp
P661	23363607	Headphone Jack, 3.5mm
△ P801	23176594	Power Cord
PV01	23365597	Phono Jack, 6P
PV02B	23901837	Socket, 3P
PV05B	23901836	Socket, 4P
PV06	23367681	Plug, 8P
PV07	23367681	Plug, 8P
PV40	23365361	Jack, 4P
S001	23145412	Switch, Slide, 2C2P
S201	23145538	Switch, Push, 2C1P
S202	23145682	Switch, Lever, 1C3P
S301	23145542	Switch, Lever, 1C3P
S601	23145318	Switch, Slide, 2C3P
△ S801	23145434	Switch, Power, 2C2P
SA01	23145430	Switch, Push, 1C1P
SA02	23145430	Switch, Push, 1C1P
SA03	23145430	Switch, Push, 1C1P
SA04	23145430	Switch, Push, 1C1P
SA05	23145430	Switch, Push, 1C1P
SA06	23145430	Switch, Push, 1C1P
SA11	23145430	Switch, Push, 1C1P
△ V901A	23902019	Socket, CRT, 10P
V901C	23192818	Sticker, Z2013A
V901M	23102893	Magnet, Purity-Convergence, MAG-1037
W201	23250875	Delay Line, TRF2080

Location No.	Part No.	Description
W661	23151258	Speaker, SPK-1258, 70x130mm, 8 ohm
W662	23151258	Speaker, SPK-1258, 70x130mm, 8 ohm
X401	23153886	Ceramic Resonator, 503kHz, TCR1012
X501	23153979	Crystal, 4.43MHz
X502	23153797	1H-Delay Line, PAL/SECAM, ED645A41T
XN01	23153961	Crystal, 3.58MHz
Z240	23107658	Ceramic Video Trap, 5.74MHz, TCF1052
Z241	23107911	Ceramic Video Trap, 5.5 to 6MHz, TCF1019
Z671	23107947	Ceramic Filter, 5.5MHz, SFE5.5MBF
Z672	23107948	Ceramic Filter, 6.0MHz, SFE6.0MBF
Z673	23107949	Ceramic Filter, 6.5MHz, SFE6.5MBF
Z674	23153900	Ceramic Resonator, 500kHz, TCR1010
Z675	23107948	Ceramic Filter, 6.0MHz, SFE6.0MBF
Z676	23107980	Ceramic Filter, 4.5MHz, SFE4.5MB
ZA01	23153845	Ceramic Resonator, 4MHz, TCR1015
ZA02	24094651	Capacitor Block, 100pFx4, 50V
ZN01	23107913	Ceramic Video Trap, 6.5MHz, TCF1018
ZN04	23107976	Ceramic Video Trap, 4.5MHz, TPS4.5MC2
ZZ01	23107502	Filter, Glass Comb, UGL-310KNT
ZZ02	23107849	Ceramic Video Trap, 4.43MHz, TCF1032
<b>PC BOARD ASSEMBLIES</b>		
U902	23337511	Main Board, PB0985
U903A	23337516	Back Terminal Board, PB0987-1
U904A	23337512	CRT Drive Board, PB0986-1
U904B	23337513	Audio Board, PB0986-2
U904C	23337515	Power Board, PB0986-3
U904D	23337517	System Board, PB0986-4
<b>PICTURE TUBE</b>		
△ V901	A5580639	Picture Tube, A66KHP96X, SVC
<b>TUNER</b>		
H001	23121729	Tuner, VHF/UHF, EG444V
<b>REMOTE HAND SET PARTS</b>		
K902	23120601	Remote Hand Unit, CT-9430
AT01	23304078	Upper Case
AT02	23300919	Lower Case
AT03	23300920	Battery Cover
AT04	23300921	Filter
ST01	23300937	Rubber Sheet
UT01	23335539	PC Board, PW6994

Location No.	Part No.	Description
ZT01	23153736	Ceramic Resoantor, CSB455EB20

Location No.	Part No.	Description
--------------	----------	-------------

MAIN BOARD PB0985  
BOTTOM (FOIL) SIDE

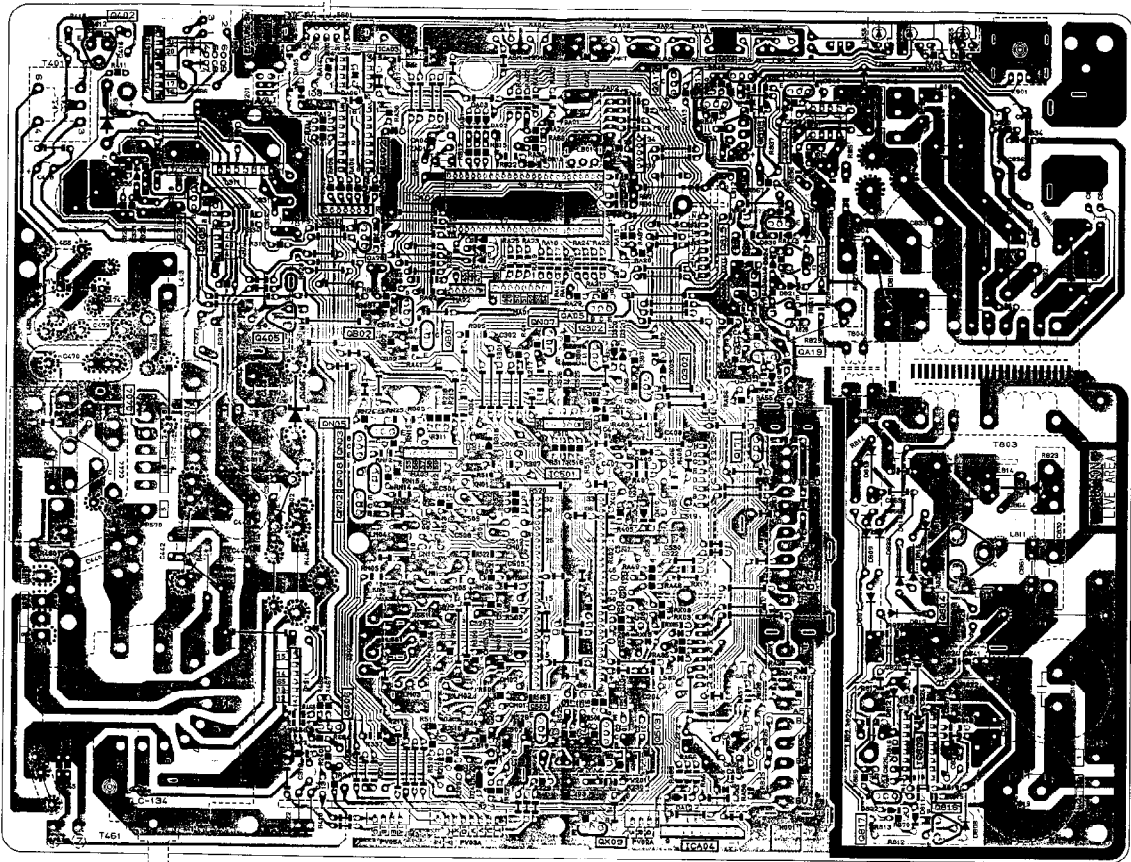

BACK TERMINAL BOARD PB0987  
BOTTOM (FOIL) SIDE

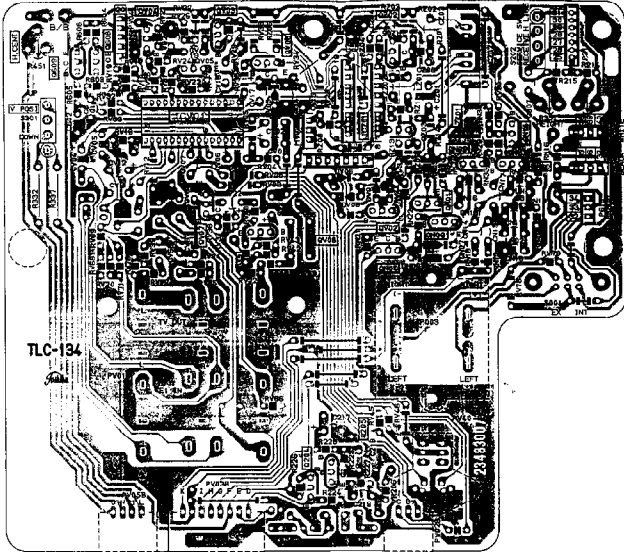

SYSTEM BOARD PB0986-4  
BOTTOM (FOIL) SIDE

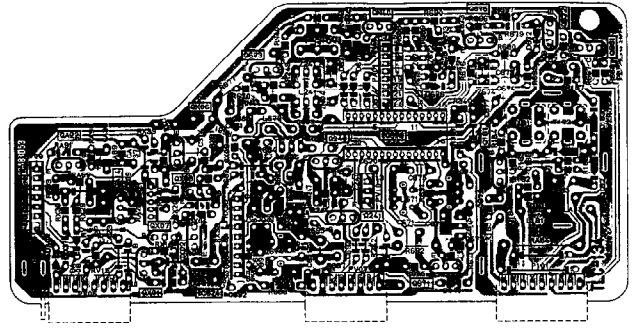

CRT DRIVE BOARD PB0986-1  
BOTTOM (FOIL) SIDE

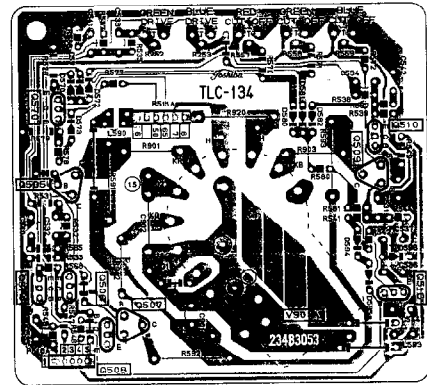



DPC/AUDIO BOARD PB0986-2  
BOTTOM (FOIL) SIDE

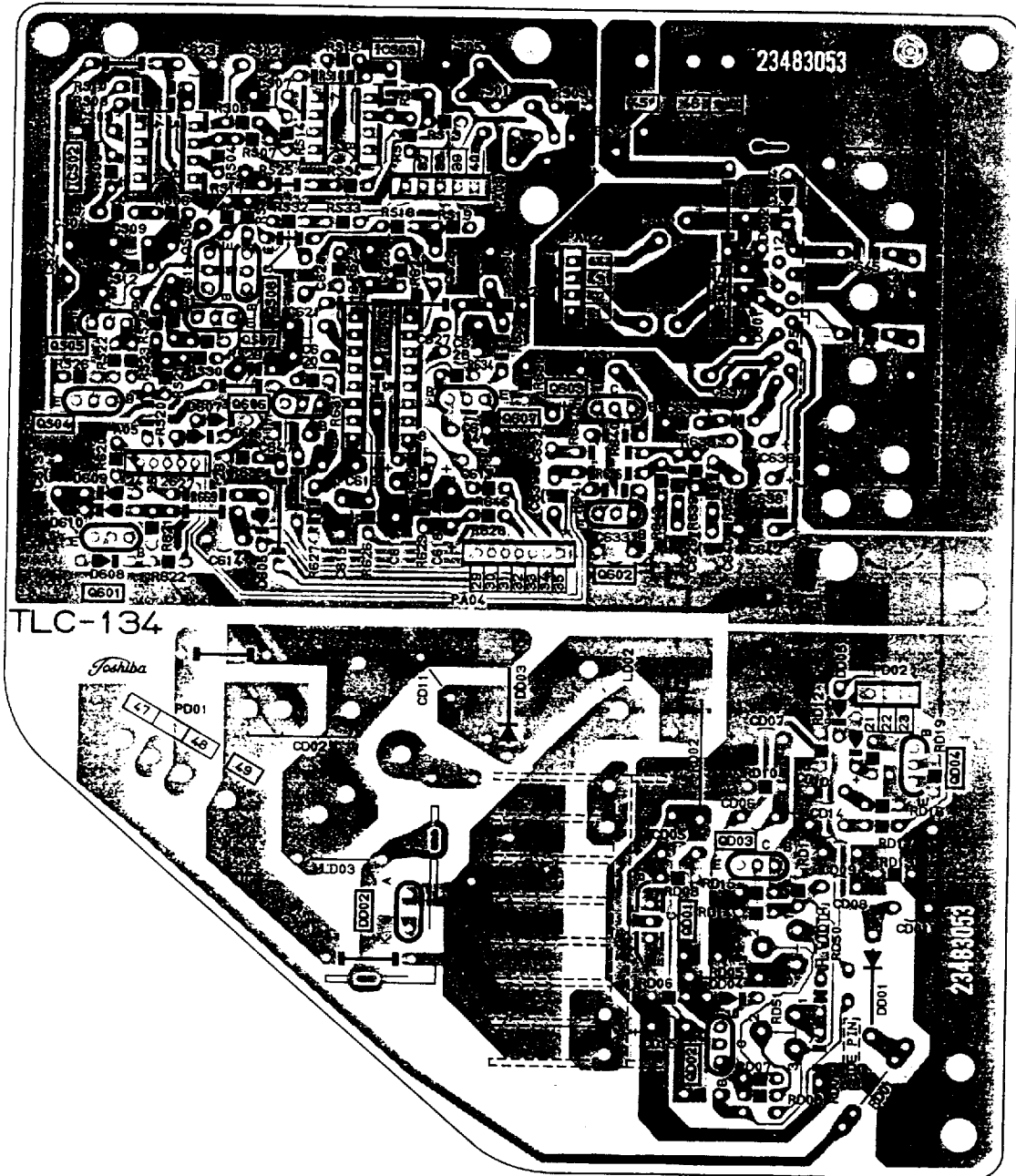

POWER BOARD PB0986-3  
BOTTOM (FOIL) SIDE

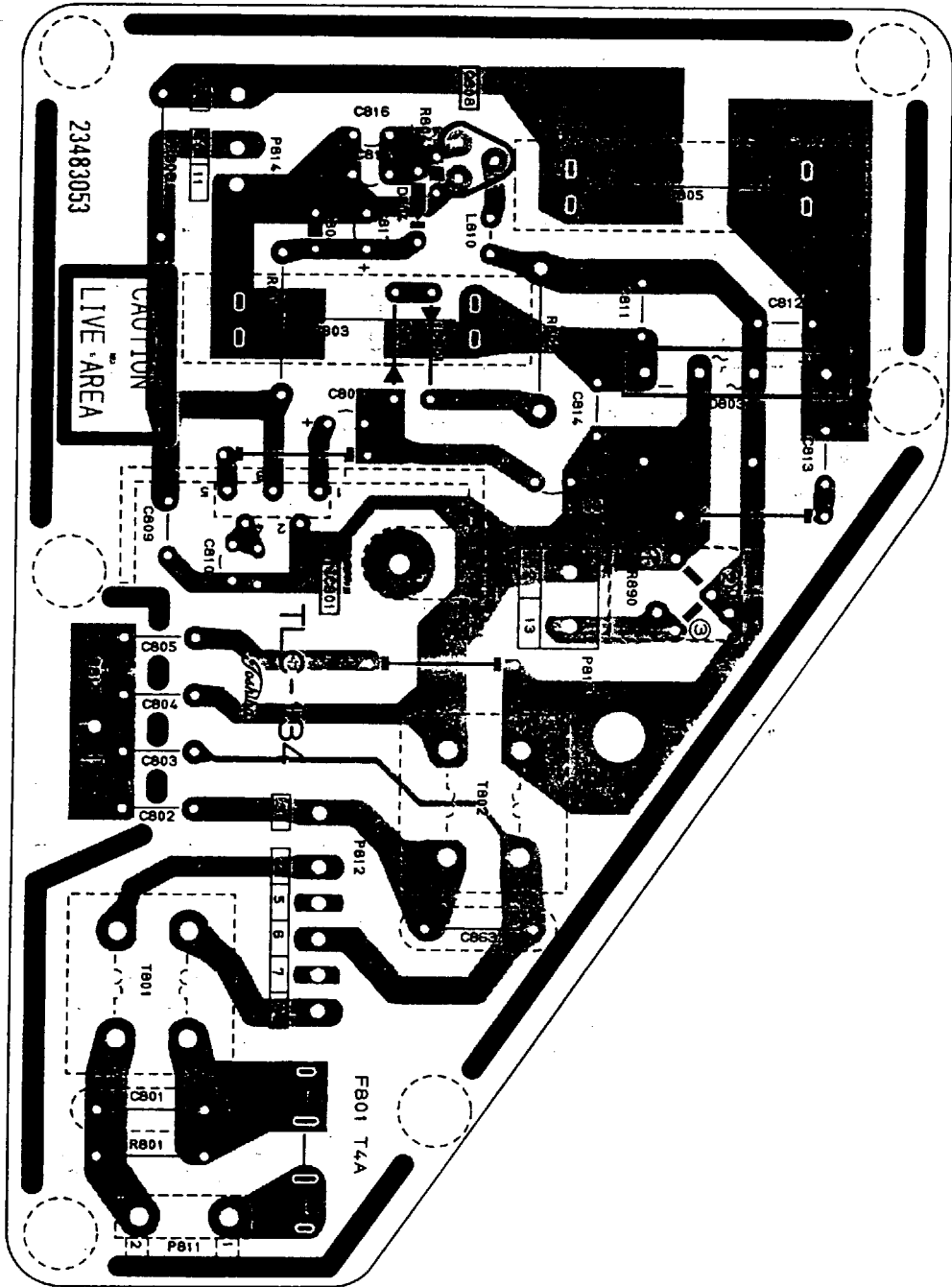

## TERMINAL VIEW OF TRANSISTORS

- ① 2SA1015  
2SC388ATM  
2SC1815  
2SA562TM  
2SC1959  
2SC1627  
2SC2878



- ② 2SC2120  
2SC2230  
2SC2655



- ③ RN1203  
RN1204  
RN1206



- ④ 2SA1265N

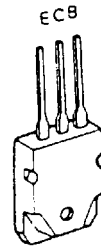

- ⑤ 2SD553  
2SC1569  
2SC2383  
2SC3148  
2SA1012

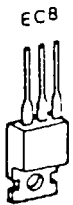

- ⑥ 2SC3619

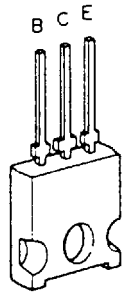

- ⑦ 2SD1428

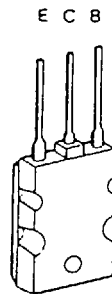

- ⑧ SF5J42

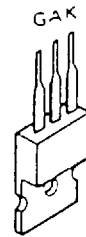

(SCR)

# SCHEMATIC DIAGRAM MODEL 2806XH

NOTE: The parts identified by the international hazard symbols are critical for safety. Replace only with part number specified.

## OBSERVATION OF VOLTAGES AND WAVEFORMS

1. Voltages read with VTVM from point shown to chassis ground, line voltage 220 volts, colour bar signal.
2. Voltages reading may vary  $\pm 20\%$ .
3. The schematic shown is representative only.
4. All waveforms are taken using a wide band oscilloscope and a low capacity probe.
5. Check FINE TUNING, BRIGHTNESS, CONTRAST and COLOUR controls for best picture, make sure that CONTRAST and COLOUR controls are in mid position and BRIGHTNESS control is almost in maximum position.
6. Waveforms are taken using a standard colour bar signal.

## NOTES:

1. D.C. resistance value of a principal transformer is shown in the schematic. These are measured for separated from the circuit.
2. The circuits are subject to change without notice.
3.  Solder links.

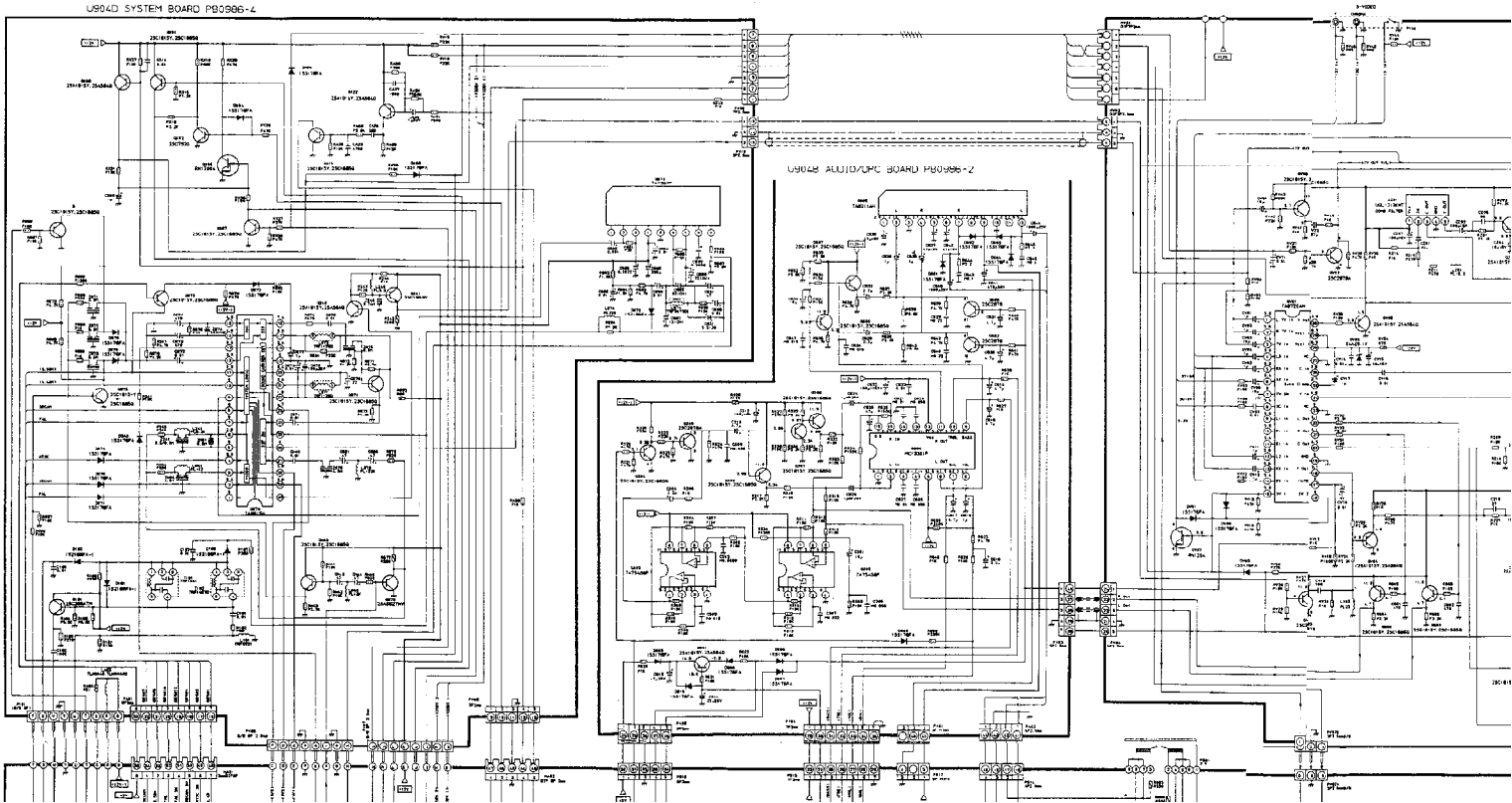

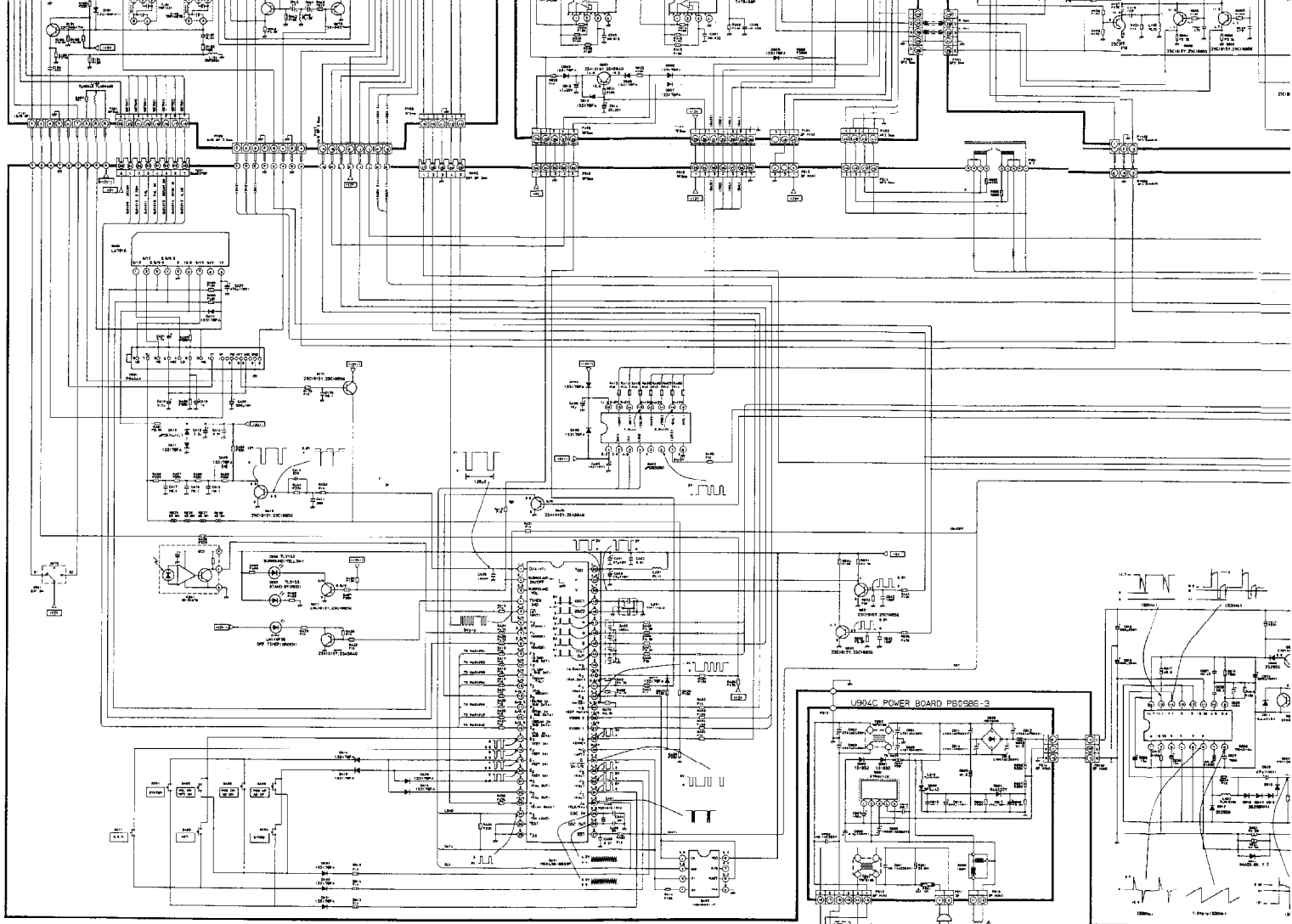

U802 MAIN BOARD PB09B5

NOTES:  
 D.C. resistance value of a principal transformer is shown in this schematic diagram. These are measured for separated from the circuit.  
 The circuits are subject to change without notice.  
 ● Solder links.

EXPRESSION

VALUE OF RESISTOR, CAPACITOR and INDUCTOR

1. Resistance is shown in ohm, k=1,000, M=1,000,000
2. Unless other wise noted in schematic, all capacitor values less than 1 are expressed in  $\mu F$  and the values more than 1 in pF.
3. Unless otherwise noted in schematic, all inductor values more than 1 are expressed in  $\mu H$ , and the values less than 1 in H.

RESISTOR

Table 1	
Type	Mark
Carbon Composition	S
Oxide Metal Film	R
Insulated Carbon Film	P
Wire Wound	W
Cement	No Mark
Variable Resistor	
Positive Thermistor	
Negative Thermistor	
Fusible Resistor	FR

Table 2

Watt	Mark	Watt	Mark
1/8 W		1/3 W	
1/8 W		5 W	
1/4 W		10 W	
1/2 W		15 W	
1 W		20 W	
2 W		25 W	

CAPACITOR

Table 3	
Type	Mark
Ceramic Disc 50V Only	
Electrolytic	
Electrolytic Non-Polar	
Variable Capacitor	
Other	

