

1.8°28mm

混合式步进电机参数 Hybrid Stepper Motor

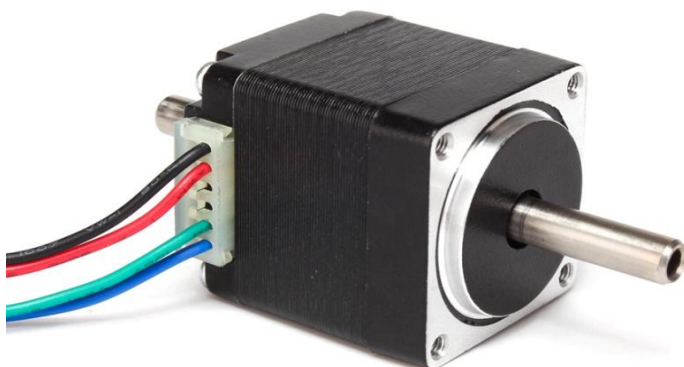

通用参数 General Specifications

Item	Specifications
步距角 Step Angle	1.8°
步距角精度 Step Angle Accuracy	±5%
电阻精度 Resistance Accuracy	±10%
电感精度 Inductance Accuracy	±20%
温升 Temperature Rise	80°C Max(Rated Current,2 phase power)
工作环境温度 Ambient Temperature	-20°C - +50°C
绝缘电阻 Insulation Resistance	100MΩMin,500VDC
介电强度 Dielectric Strength	500VAC,1 minute
径向跳动 Radial Runout	0.02 Max.(450g load)
轴向跳动 Axial Runout	0.08 Max.(450g load)
径向负载 Radial Load	28N(20mm from Flange)
轴向负载 Axial Load	10N

性能规格书 The Performance Specification

型号	保持转矩	额定电流	相电阻	相电感	转动惯量	出线数	电机重量	机身长度
Model	Holding torque (mN.m)	Rated Current (A)	Resistance (Ω)	Inductance (mH)	Rotor Inertia (g.cm ²)	Leads (No.)	Motor Weight (kg)	Motor Length (mm)
28HS2601-XX	43	0.95	2.8	0.8	9	6	0.11	31.5
28HS2401-XX	60	0.67	5.6	3.4		4		
28HS5601-XX	75	0.95	3.4	1.2	12	6	0.14	44.5
28HS5401-XX	95	0.67	6.8	4.9		4		
28HS7601-XX	90	0.95	4.6	1.8	18	6	0.2	50.5
28HS7401-XX	120	0.67	9.2	7.2		4		

1.8°28mm

混合式步进电机参数 Hybrid Stepper Motor



尺寸图 Mechanical Dimensions

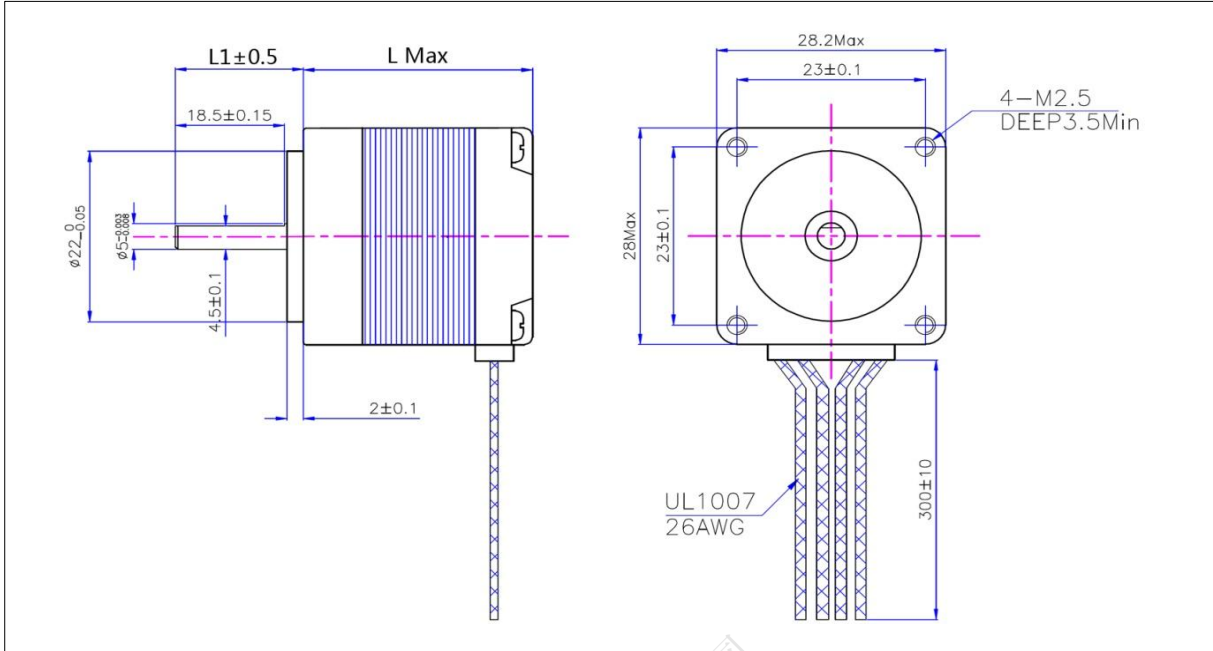

力矩曲线 Torque Curve

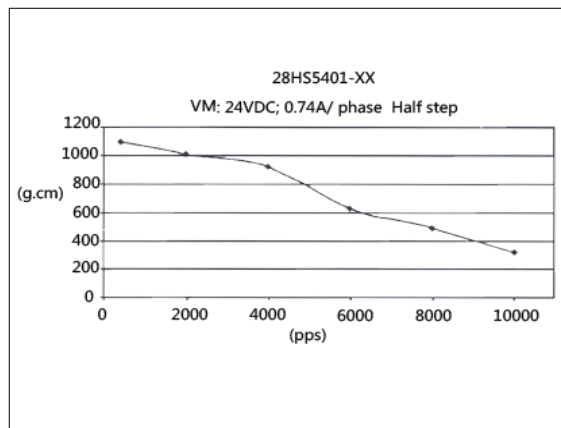
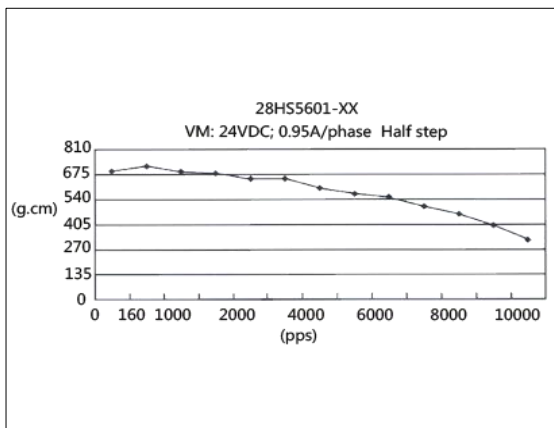
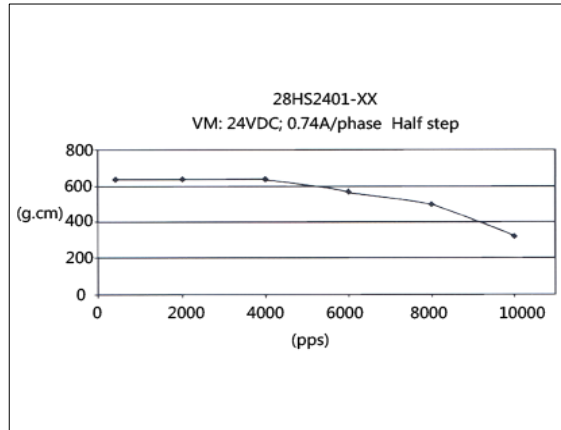
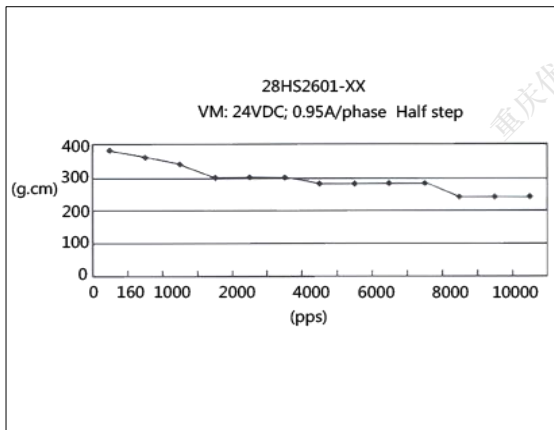

1.8°28mm

混合式步进电机参数 Hybrid Stepper Motor



力矩曲线 Torque Curve

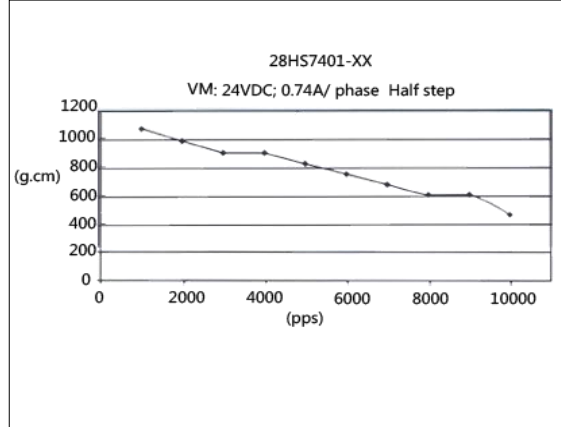
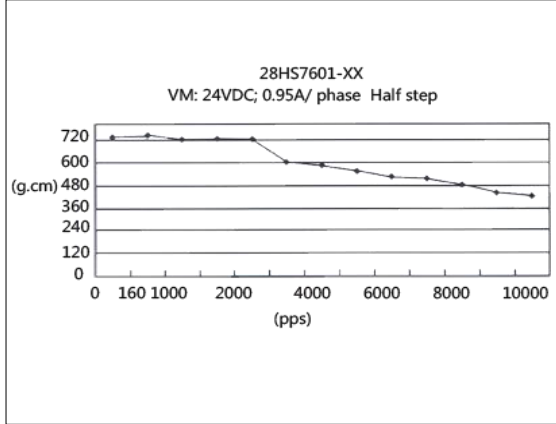

重庆优摩特科技有限公司