

TOSHIBA

FILE NO. 030-200314

SERVICE MANUAL

Colour television

Z33 Chassis

28Z33B/32Z33B

TABLE OF CONTENTS

CHAPTER 1 GENERAL ADJUSTMENTS

SAFETY INSTRUCTIONS	3
SET-UP ADJUSTMENT	4
SERVICE MODE	8
DESIGN MODE	11
ELECTRICAL ADJUSTMENTS	12
CIRCUIT CHECK	14

CHAPTER 2 SPECIFIC INFORMATIONS

SETTING & ADJUSTING DATA	15
LOCATION OF CONTROLS	16
CHASSIS AND CABINET REPLACEMENT PARTS LIST	18
PC BOARDS TOP & BOTTOM VIEW	25
TERMINAL VIEW OF TRANSISTORS	33
CIRCUIT BLOCK DIAGRAM	36
SPECIFICATIONS	END

APPENDIX:

CIRCUIT DIAGRAM

SAFETY INSTRUCTIONS

WARNING: BEFORE SERVICING THIS CHASSIS, READ THE “X-RAY RADIATION PRECAUTION”, “SAFETY PRECAUTION” AND “PRODUCT SAFETY NOTICE” INSTRUCTIONS BELOW.

X-RAY RADIATION PRECAUTION

1. Excessive high voltage can produce potentially hazardous X-RAY RADIATION. To avoid such hazards, the high voltage must not be above the specified limit. The nominal value of the high voltage of this receiver is (A) kV at zero beam current (minimum brightness) under a (C) V AC power source. The high voltage must not, under any circumstances, exceed (B) kV.
Refer to table-1 for high voltage (A), (B) & AC voltage (C). (See SETTING & ADJUSTING DATA on page 15)
2. The only source of X-RAY RADIATION in this TV receiver is the picture tube. For continued X-RAY RADIATION protection, the replacement tube must be exactly the same type tube as specified in the parts list.
3. Some part in this receiver have special safety-related characteristics for X-RAY RADIATION protection. For continued safety, parts replacement should be undertaken only after referring to the PRODUCT SAFETY NOTICE below.

Each time a receiver requires servicing, the high voltage should be checked following the HIGH VOLTAGE CHECK procedure in this manual. It is recommended that the reading of the high voltage be recorded as a part of the service record. It is important to use an accurate and reliable high voltage meter.

SAFETY PRECAUTION

WARNING : Service should not be attempted by anyone unfamiliar with the necessary precautions on this receiver. The following are the necessary precautions to be observed before servicing this chassis.

1. An isolation transformer should be connected in the power line between the receiver and the AC line before any service is performed on the receiver.
2. Always discharge the picture tube anode to the CRT conductive coating before handling the picture tube. The picture tube is highly evacuated and if broken, glass fragments will be violently expelled. Use shatter proof goggles and keep picture tube away from the unprotected body while handling.
3. When replacing a chassis in the cabinet, always be certain that all the protective devices are put back in place, such as; non-metallic control knobs, insulating covers, shields, isolation resistor-capacitor network etc.

PRODUCT SAFETY NOTICE

Many electrical and mechanical parts in this chassis have special safety-related characteristics. These characteristics are often passed unnoticed by a visual inspection and the protection afforded by them cannot necessarily be obtained by using replacement components rated for higher voltage, wattage, etc. Replacement parts which have these special safety characteristics are identified in this manual and its supplements; electrical components having such features are identified by the international hazard symbols on the schematic diagram and the parts list.

Before replacing any of these components, read the parts list in this manual carefully. The use of substitute replacement parts which do not have the same safety characteristics as specified in the parts list may create shock, fire, X-ray radiation or other hazards.

WARNING: BEFORE SERVICING THIS CHASSIS, READ THE "X-RAY RADIATION PRECAUTION", "SAFETY PRECAUTION" AND "PRODUCT SAFETY NOTICE" ON PAGE 3 OF THIS MANUAL.

SET-UP ADJUSTMENT

■ The following adjustments should be made when a complete realignment is required or a new picture tube is installed. Perform the adjustments in order as follows :

1. Color Purity
2. Convergence
3. White Balance

Note: The PURITY/CONVERGENCE MAGNET assembly and rubber wedges need mechanical positioning.

Refer to figure 1.

Mounting position of the purity magnet assembly should fit to same position as old one because slightly difference to the position depend on a kind of tube.

* There are no adjustment of purity and convergence in some picture tube (Unified with purity magnet)

COLOR PURITY ADJUSTMENT

NOTE : Before attempting any purity adjustments, the receiver should be operated for at least fifteen minutes.

1. Demagnetize the picture tube and cabinet using a degaussing coil.
2. Set the brightness and contrast to maximum.
3. Use a green raster from among the built-in test signals.
4. Loosen the clamp screw holding the yoke and slide the yoke backward or forward to provide vertical green belt (zone) in the picture screen.

5. Remove the Rubber Wedges.

6. Rotate and spread the tabs of the purity magnet (See figure 2.) around the neck of the picture tube until the green belt is in the center of the screen. At the same time, enter the raster vertically.

7. Slowly move the yoke forward or backward until a uniform green screen is obtained. Tighten the clamp screw of the yoke temporarily.

8. Check the purity of the red and blue raster.

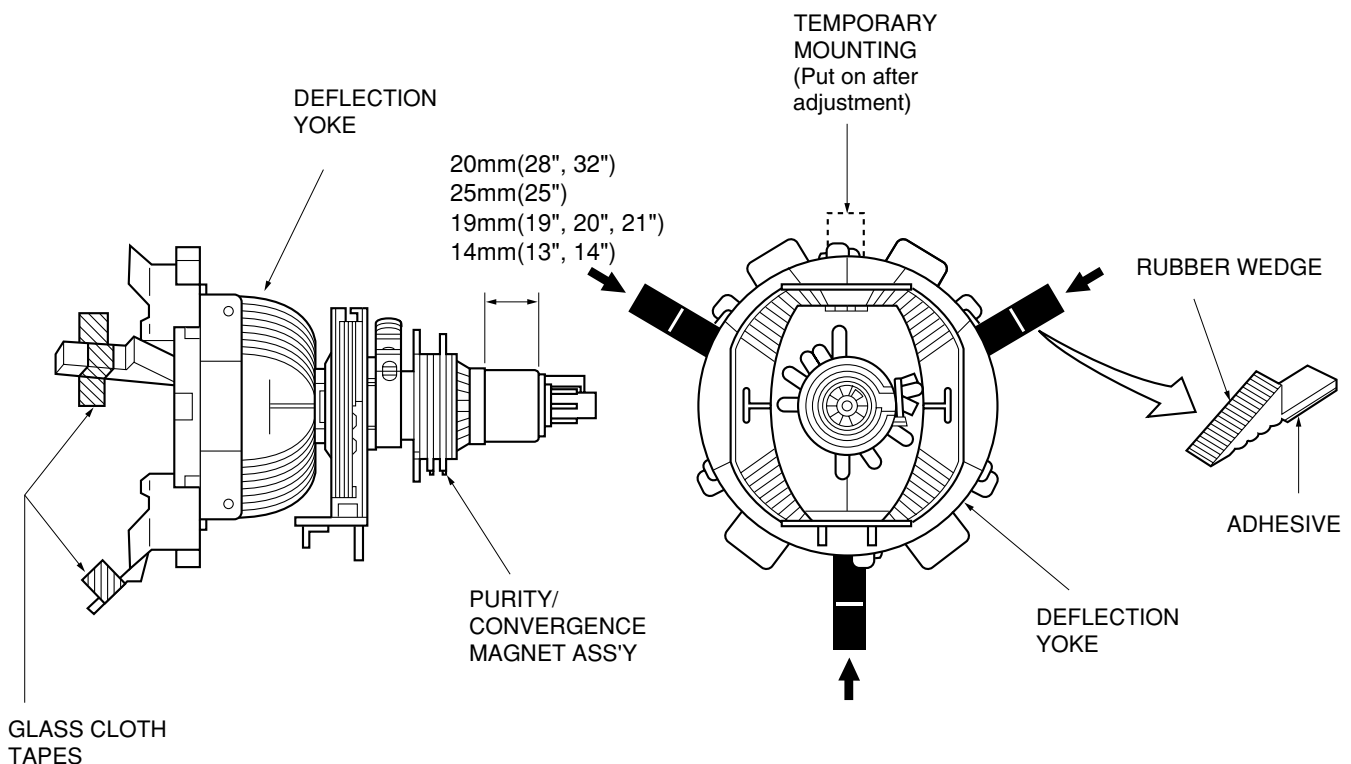

Figure 1.

CONVERGENCE ADJUSTMENTS

NOTE: Before attempting any convergence adjustments, the receiver should be operated for at least fifteen minutes.

■ **CENTER CONVERGENCE ADJUSTMENT**

1. Use the cross-dot pattern from among the built-in test signals.
2. Set the brightness and contrast for well defined pattern.
3. Adjust two tabs of the 4-Pole Magnets to change the angle between them (See figure 2.) and superimpose red and blue vertical lines in the center area of the picture screen.
4. Turn the both tabs at the same time keeping the angle constant to superimpose red and blue horizontal lines at the center of the screen.
5. Adjust two tabs of 6-Pole Magnets to superimpose red/blue line and green one. Adjusting the angle affects the vertical lines and rotating both magnets affects the horizontal lines.
6. Repeat adjustments 3, 4, 5 keeping in mind red, green and blue movement, because 4-Pole Magnets and 6-Pole Magnets have mutual interaction and make dot movement complex.

■ **CIRCUMFERENCE CONVERGENCE ADJUSTMENT**

1. Loosen the clamping screw of deflection yoke slightly to allow the yoke to tilt.
2. Temporarily put a wedge as shown in figure 1. (Do not remove cover paper on adhesive part of the wedge.)
3. Tilt front of the deflection yoke up or down to obtain better convergence in circumference. (See figure 3.) Push the mounted wedge into the space between picture tube and the yoke to fix the yoke temporarily.
4. Put other wedge into bottom space and remove the cover paper to stick.
5. Tilt front of the yoke right or left to obtain better convergence in circumference. (See figure 3.)
6. Keep the yoke position and put another wedge in either upper space. Remove cover paper and stick the wedge on picture tube to fix the yoke.
7. Detach the temporarily mounted wedge and put it in another upper space. Stick it on picture tube to fix the yoke.
8. After fixing three wedges, recheck overall convergence. Tighten the screw firmly to fix the yoke and check the yoke is firm.
9. Stick three adhesive tapes on wedges as shown in figure 1.

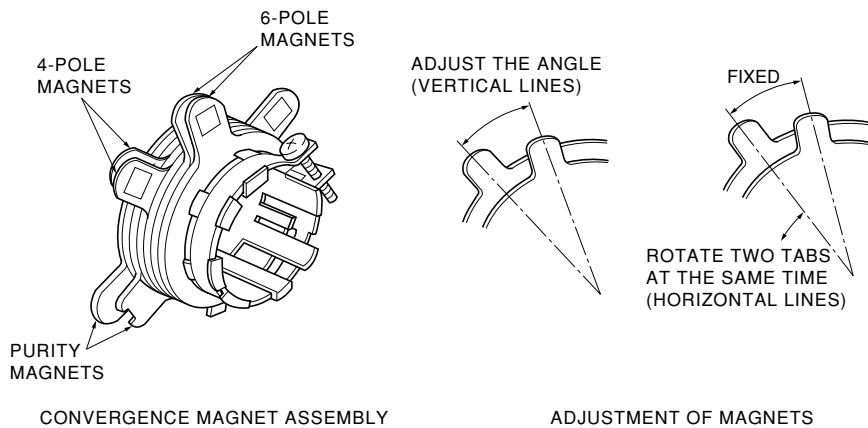
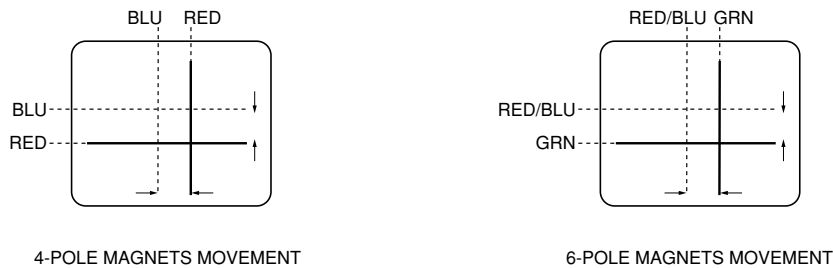

Figure 2.



Center Convergence by Convergence Magnets



Circumference Convergence by DEF Yoke

Figure 3. Dot Movement Pattern

WARNING: BEFORE SERVICING THIS CHASSIS, READ THE "X-RAY RADIATION PRECAUTION", "SAFETY PRECAUTION" AND "PRODUCT SAFETY NOTICE" ON PAGE 3 OF SERVICE MANUAL.

SET-UP ADJUSTMENT (FOR FLAT TUBE)

■ The following adjustments should be made when a complete realignment is required or a new picture tube is installed. Perform the adjustments in order as follows :

1. Color Purity
2. Convergence
3. White Balance

Note: The PURITY/CONVERGENCE MAGNET assembly and rubber wedges need mechanical positioning. Refer to figure 1.

COLOR PURITY ADJUSTMENT

- (1) Let the screen face in the installing direction or toward the east (when it is to be moved), bring up the service mode screen after demagnetizing (front, left, right, and top) with the degaussing coil, receive white signals by pressing the [TV/VIDEO] button, and then the receiver should be operated for more than 40 minutes.
- (2) Perform rough adjustment of the central convergence with the P/C magnet according to the adjustment item.
- (3) Receive built-in green signals, loosen set screws on the deflection yoke, remove rubber wedges, and shift the deflection yoke toward front.
- (4) Move alternately the two 2-pole magnets of the P/C magnets so that the green raster can come to the center of the screen.

Figure 1.

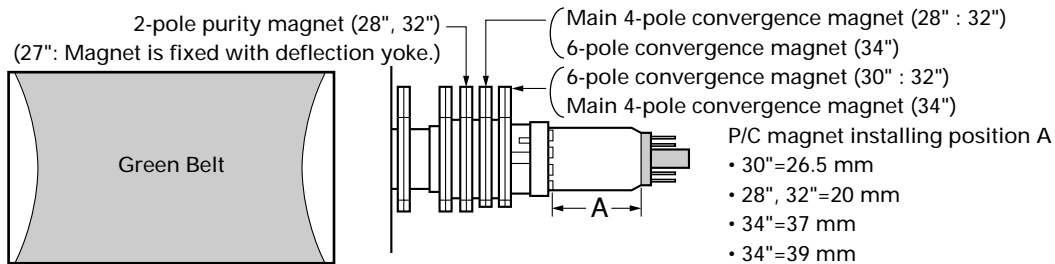

- (5) Receive built-in red and blue signals, check that there is no inclination of the single color raster toward one side, and if each color tilts to a great extent, make adjustment with the 2-pole magnet so that the 3 colors will come to the center evenly.
- (6) Receive the green raster, shift the deflection yoke from a foremost position (hitting against the picture tube) to a backward position horizontally, stop the deflection yoke at a position where it begins to become a green raster, and perform accurate marking on the picture tube.
- (7) Shift the deflection yoke further backward, and perform accurate marking at a position where the green raster begins to be off.
- (8) Fix the deflection yoke at a position 60% forward within the range marked in items (6) and (7) above.

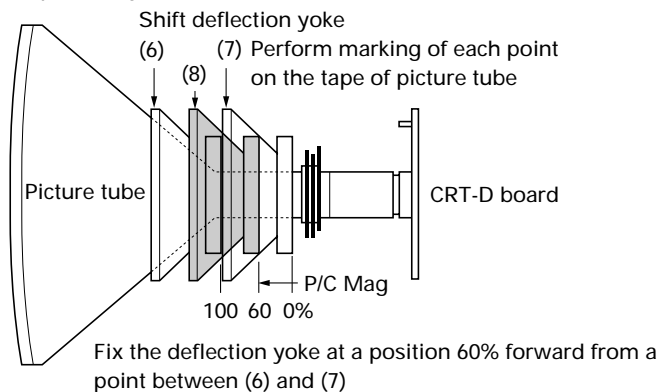

CONVERGENCE ADJUSTMENTS

* Adjust the convergence magnet to get best convergence in the order to (1) ~ (5).

■ CENTER CONVERGENCE:

- (1) Receive the white crosshatch or dot pattern from the service signal generator.
- (2) Use the 2 pieces of main 4-pole magnets of P/C magnets, change the open angle, and align the red and blue vertical lines on the screen center.
- (3) Freeze the open angle of the main 4-pole magnets, turn them simultaneously, and align the horizontal lines.
- (4) Take the same steps for items (2) and (3) above and align red/blue with green on the screen center using two 6-pole magnets.

(5) Adjust the sub-4-pole magnets only in case there is any deviation of Xv bow-shaped convergence. (To be usually set at the initial position)
Align both sides with the sub-4-pole magnets and minimize the deviation of blue and red with the main 4-pole magnets.

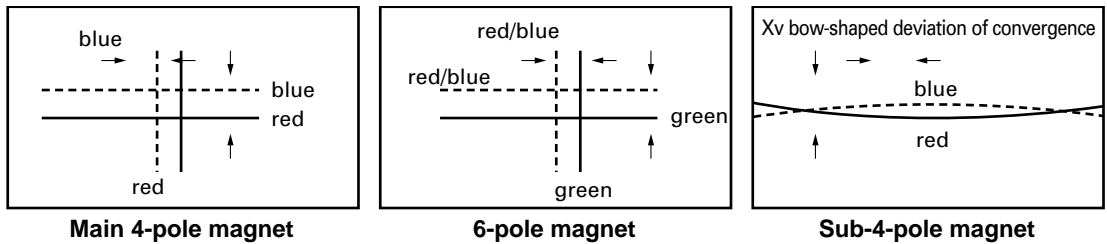

■ CIRCUMFERENCE CONVERGENCE:

* Perform correction in the following manner.

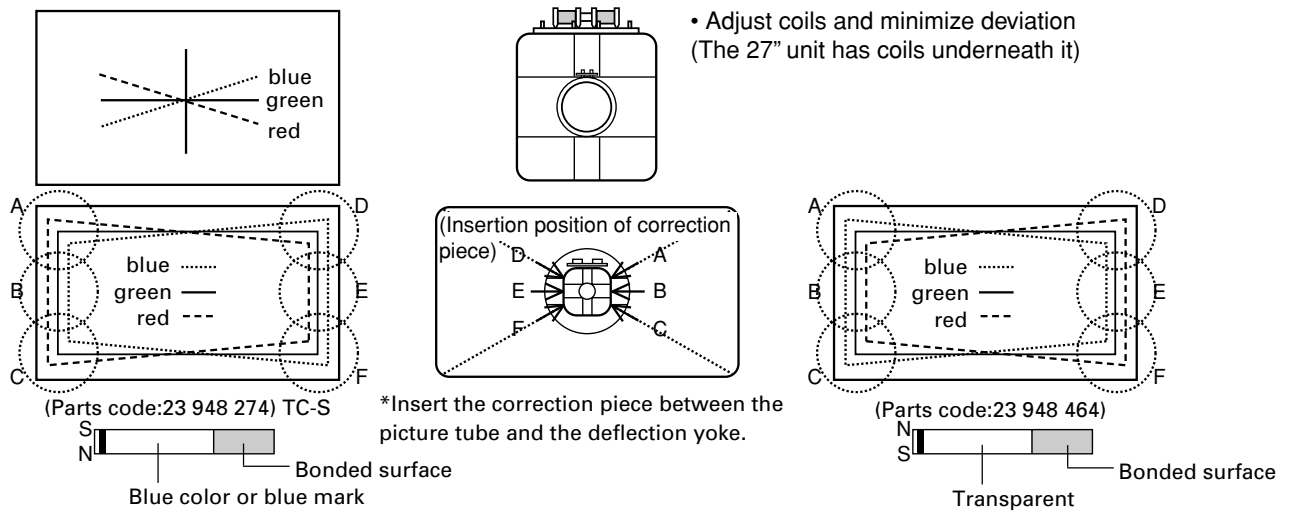

• Adjust coils and minimize deviation (The 27" unit has coils underneath it)

Adjust VR 1 and minimize the deviation of YH. *Only 27" and 30".

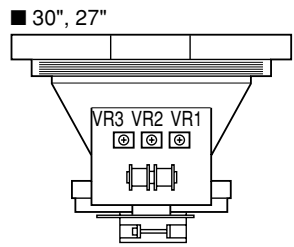
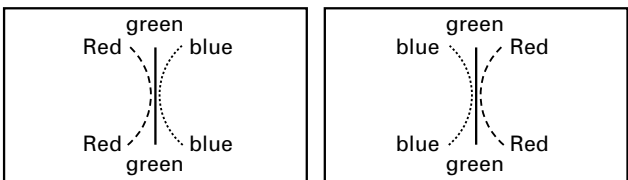

Adjust VR 2 (YHC) and minimize the deviation of YH.

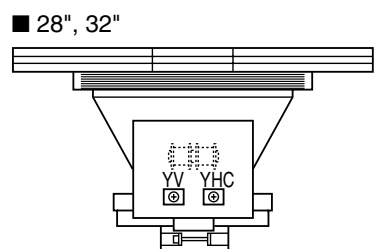
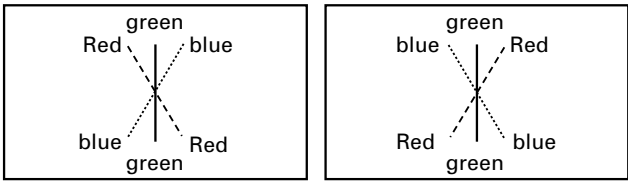

Adjust VR 3 (YV) and minimize the deviation of YV.

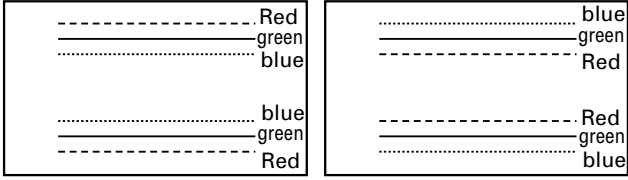

- 27" (Part No. 23 947 371)
- 32", 30" (Part No. 23 947 121)
- 34" (Part No. 23 993 080)

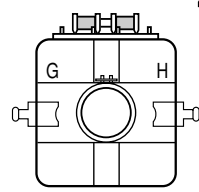
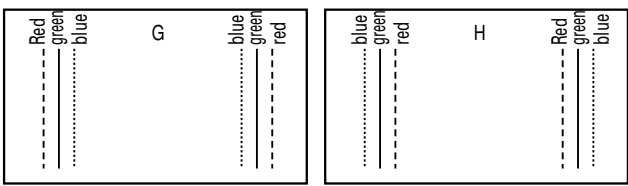



Perform correction by inserting the correction piece into the clearance of terminal board coils of the deflection yoke.

Note:
Perform insertion by turning the metal side to the terminal board side of the deflection yoke.

SERVICE MODE

1. ENTERING TO SERVICE MODE

- 1) Press  button once on Remote Control.
- 2) Press  button again to keep pressing.
- 3) While pressing the  button, press MENU button on TV set.

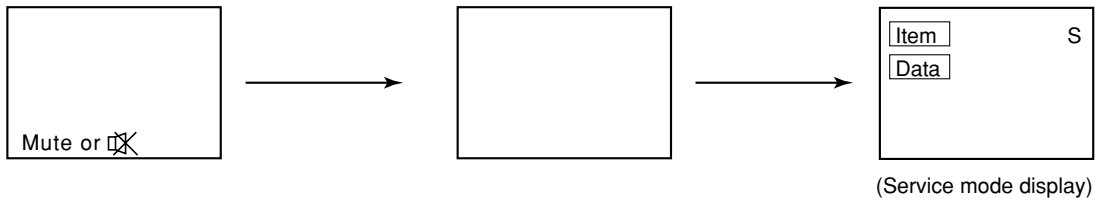

2. DISPLAYING THE ADJUSTMENT MENU

- 1) Press MENU button on TV.

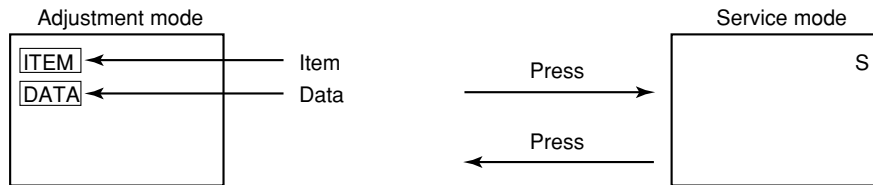

3. KEY FUNCTION IN THE SERVICE MODE

The following key entry during display of adjustment menu provides special functions.

A single horizontal line ON/OFF:

Test signal selection :

Selection of the adjustment items :

Change of the data value :

Adjustment menu mode ON/OFF :

Initialization of the memory (QA02) :

Reset the count of operating protect circuit to "00":

"RCUT" selection :

"GCUT" selection :

"BCUT" selection :

"SCNT" selection :



"COLC" selection :

"TNTC" selection :

Self diagnostic display ON/OFF :

INFO button (on Remote) or  button (on TV)

 button (on Remote)

Channel /  (on TV or Remote)

Volume  +/- (on TV or Remote)

MENU button (on TV)

CALL + Channel button on TV ()

CALL + Channel button on TV ()

1 button

2 button

3 button - - - Color thickness correction

4 button

5 button

6 button

9 button

note: Displayed differently as shown below, depending on the setting of the receiving color system.

COLC (PAL/NTSC)

COLS (SECAM)

CAUTION : Never try to perform initialization unless you have changed the memory IC.

4. SELECTING THE ADJUSTING ITEMS

- 1) Every pressing of CHANNEL ▲ button in the service mode changes the adjustment items in the order of table-2. (▼ button for reverse order)

Refer to table-2 for preset data of adjustment mode.
(See SETTING & ADJUSTING DATA on page 15)

5. ADJUSTING THE DATA

- 1) Pressing of VOLUME ▲ +/- button will change the value of data in the range from 00H to FFH. The variable range depends on the adjusting item.

6. EXIT FROM SERVICE MODE

- 1) Pressing POWER button to turn off the TV once.

■ INITIALIZATION OF MEMORY DATA OF QA02

After replacing QA02, the following initialization is required.

1. Enter the service mode, then select any register item.
2. Press and hold the CALL button on the Remote, then press the CHANNEL ▲ button on the TV. The initialization of QA02 has been completed.
3. Check the picture carefully. If necessary, adjust any adjustment item above.
Perform "Auto search Memory" on the owner's manual.

CAUTION: Never attempt to initialize the data unless QA02 has been replaced.

7. TEST SIGNAL SELECTION

- 1) Every pressing of -⊖ button on the Remote Control changes the built-in test patterns on screen as described below in SERVICE MODE.

Signal off → NTSC signals (5 patterns)
↑ PAL signals (5 patterns) ←

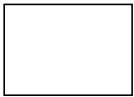
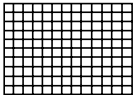
Signals	Picture
<ul style="list-style-type: none"> • Red raster • Green raster • Blue raster • All White 	
<ul style="list-style-type: none"> • Black cross-hatch 	

* The signals marked with ■ are not usable to display in the Test signal for some model.

8. SELF DIAGNOSTIC FUNCTION

- 1) Press "9" button on Remote Control during display of adjustment menu in the service mode.
The diagnosis will begin to check if interface among IC's are executed properly.
- 2) During diagnosis, the following displays are shown.

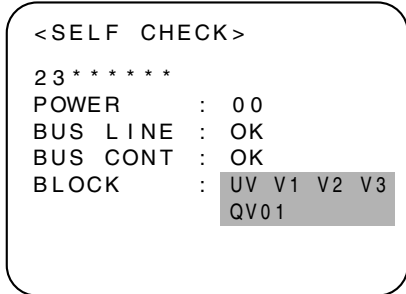

Indicated color of mode now selected : Green and Red
 Indicated color of other modes : White

Green : Normal
 Red : The microcomputer operates to provide judgement of no video signal. The red color is still indicated though the signal is input, failure may exist in input signal line including QV01.

QV01 : In case of indication green ---Normal
 In case of indication red with input signal---
 Failure may exist in output line including QV01.

- ① Part number of microcomputer (QA01)
- ② Operation number of protecting circuit ----"00" is normal.
When indication is other than "00", overcurrent apts to flow, and circuit parts may possibly be damaged.
- ③ BUS LINE CHECK ----"OK" is normal.
"SDA1-GND" ----- SDA-GND short circuit.
"SCL1-GND" ----- SCL-GND short circuit.
"SCL1-SDA1" ----- SCL-SDA short circuit.
- ④ BUS CONT ----"OK" is normal.
When indication shows "Q○○○ NG", the device with the number may possibly be damaged.
- ⑤ BLOCK
 UV : TV reception mode
 V1 : VIDEO 1 input mode (←1)
 V2 : VIDEO 2 input mode (←2)
 V3 : VIDEO 3 input mode (←3)

NOTE: Component which controls character display on screen is ICF01 (QT01) (TELETEXT IC.). If this display function fails to operate due to damage in ICF01 (QT01), self diagnosis procedure is as follows.

- (1) In case that power indicator is blinking with interval of 0.5 seconds; it means protecting circuit (Current limiter) is operating, and circuit components may possibly be damaged. Check related components.
- (2) In case that power indicator is blinking with interval of 1 second; Protecting circuit does not operate, but a part of Bus line does not operate normally. Check Bus line.

* The items marked with ■ are not usable to display in the SELF DIAGNOSTIC FUNCTION for some model.

DESIGN MODE

1. ENTERING TO DESIGN MODE

- 1) Select the Service mode.
- 2) While pressing \times or CALL button on Remote and press MENU button on TV.
- 3) Press MENU button on TV.

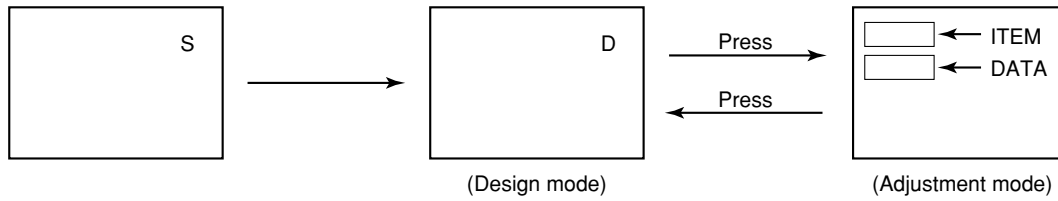

When QA02 is initialized, items "OPT0", "OPT1" and "OPT2" of DESIGN MODE are set to the data of the representative model of this chassis family.

Therefore, because ON-SCREEN specification remains in the state of the representative of model. This model is required to reset the data of items "OPT0", "OPT1" and "OPT2".

2. SELECTING THE ADJUSTING ITEMS

Every pressing of CHANNEL \blacktriangledown button in the design mode changes the adjustment items in the order of table-3. (\blacktriangle button for reverse order)

Refer to table-3 for data of design mode.
(See SETTING & ADJUSTING DATA on page 15)

3. ADJUSTING THE DATA

Pressing of VOLUME \blacktriangle or \blacktriangledown button will change the value of data.

ELECTRICAL ADJUSTMENTS

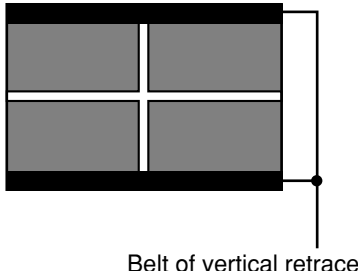
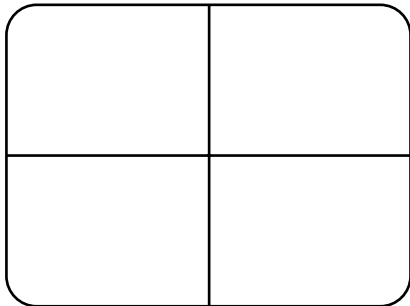
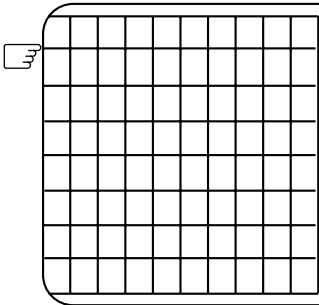
ITEM	ADJUSTMENT PROCEDURE
<p>FOCUS VR ADJ</p>	<ol style="list-style-type: none"> 1. Enter the service mode, then select any register item. 2. Press the TV/VIDEO button on the Remote until the black cross-bar pattern appears on the screen. 3. Adjust the FOCUS control (on T461) for well defined scanning lines on the picture screen.
<p>SUB-BRIGHTNESS (BRTC)</p> <p>Note: Constrict the picture height until the vertical retrace line appears adjusting the item HIT (HEIGHT).</p>	<ol style="list-style-type: none"> 1. Set CONTRAST to minimum, and BRIGHTNESS to center by adjusting user controls. 2. Set the TV in service mode to get cross-bar of inside pattern. 3. Select BRTC (brightness correction), and adjust the $\triangle - /+$ button to reduce the value so that white portion of inside pattern slightly light. 4. Adjust $\triangle - /+$ button to increase the data value of BRTC, and set it just before the difference between the belt of vertical retrace and the border of black portion of inside pattern is visible. After that, return vertical height and contrast. <div style="text-align: right;">  </div>
<p>HORIZONTAL POSITION ADJUSTMENT (HPOS)</p> <p>VERTICAL POSITION ADJUSTMENT (VPOS)</p>	<ol style="list-style-type: none"> 1. Set the TV in service mode, and get black cross-bar signal with VIDEO button on remote hand unit. 2. Select either HPOS (Horizontal picture phase) or VPS (Vertical picture phase) with CHANNEL $\blacktriangle, \blacktriangledown$ buttons, and adjust horizontal or vertical picture position in the center of screen with VOLUME $\triangle - /+$ buttons. <div style="text-align: right;">  </div>
<p>VERTICAL AMPLITUDE ADJUSTMENT (HIT)</p>	<ol style="list-style-type: none"> 1. Set the TV in service mode, and get black cross-hatch signal with VIDEO button on remote hand unit. 2. Select HIT (Vertical amplitude) with CHANNEL $\blacktriangle, \blacktriangledown$ buttons, and adjust vertical amplitude with VOLUME $\triangle - /+$ buttons so that vertical amplitude lacks a little. 3. Adjust vertical amplitude with VOLUME $\triangle - /+$ buttons so that the first bar on cross-hatch signal touches edge of screen. <div style="text-align: right;">  </div>

ITEM	ADJUSTMENT PROCEDURE
<p>WHITE BALANCE ADJUSTMENT</p> <ul style="list-style-type: none"> ● CUTOFF ADJUSTMENT (RCUT) (GCUT) (BCUT) ● DRIVE ADJUSTMENT (GDRV) (BDRV) 	<ol style="list-style-type: none"> 1. Set Contrast to 40, and brightness to +20 by picture control. 2. Receive the Black and White pattern. 3. Select RCUT, GCUT and BCUT with CHANNEL ▲, ▼ buttons, to set individual values to Initial reference data, and to set GDRV and BDRV to Initial reference data with VOLUME ▲ – /+ buttons. 4. Press [F/-] button on the remote control and rotate Screen VR to get one slight horizontal line on screen. Note: Every pressing of [F/-] button provides Horizontal line picture and Normal picture alternately. 5. Press [F/-] button to release horizontal line picture, and select the two other colors which did not light in the above step with CHANNEL ▲, ▼ buttons. Then tap VOLUME ▲ – /+ buttons so that three colors slightly light in the same level. <p>※ To correct white balance in light area, select GDRV and BDRV with CHANNEL ▲, ▼ buttons to adjust.</p> <p>※ To correct white balance in dark area, perform fine adjustment of RCUT, GCUT and BCUT.</p> <div style="border: 1px solid black; border-radius: 10px; padding: 10px; margin-top: 20px;"> <div style="border: 1px solid black; width: 150px; height: 30px; margin: 0 auto; text-align: center; padding: 5px;">Light area check (to show white)</div> <div style="text-align: center; margin-top: 100px;">Dark area check (to show black)</div> </div>

CIRCUIT CHECK

HIGH VOLTAGE CHECK

CAUTION: There is no HIGH VOLTAGE ADJUSTMENT on this chassis. Checking should be done following the steps below.

1. Connect an accurate high voltage meter to the second anode of the picture tube.
2. Turn on the receiver. Set the BRIGHTNESS and CONTRAST controls to minimum (zero beam current).
3. High voltage must be measured below (B) kV.

Refer to table-1 for high voltage (B).
(See SETTING & ADJUSTING DATA on page 15)

4. Vary the BRIGHTNESS control to both extremes to be sure the high voltage does not exceed the limit under any conditions.

CHAPTER 2 SPECIFIC INFORMATIONS

SETTING & ADJUSTING DATA

【 SAFETY INSTRUCTIONS 】

		32"	28"
HIGH VOLTAGE AT ZERO BEAM:	(A)	31.7 kV	31.4 kV
MAX HIGH VOLTAGE:	(B)	35.0 kV	33.0 kV
AC VOLTAGE	(C)	220~240 V	

Table-1

【 SERVICE MODE 】

ADJUSTING ITEMS AND DATAS IN THE SERVICE MODE:

Item	Adjustment	Reference data		Item	Adjustment	Reference data	
RCUT	R CUTOFF (B/W)	40H	←	HPOS	H-POSITION (WIDE)	0DH	←
GCUT	G CUTOFF (B/W)	40H	←	VPOS	V-POSITION (ALL)	00H	←
BCUT	B CUTOFF (B/W)	40H	←	HIT	HEIGHT (WIDE)	35H	21H
GDRV	G DRIVE	40H	←	VLIN	V-LINEARITY (WIDE)	07H	←
BDRV	B DRIVE	40H	←	WID	PICTURE WIDTH	20H	25H
BRTC	BRIGHT CENTRE	40H	←	PARA	E-W PARABOLA (WIDE)	2CH	22H
COLC	COLOR CEN PAL/NTSC	40H	←	CNR	E-W CORNER (WIDE)	00H	←
COLS	COLOR CEN SECAM	40H	←	TRAP	TRAPEZIUM (WIDE)	30H	24H
SCNT	SUB CONTRAST	00H	←	RAGC	RF AGC	1EH	←
SRY	SECAM R-Y BLACK LEVEL	08H	←	CSAW	CENTER SAW	03H	←
SBY	SECAM B-Y BLACK LEVEL	08H	←	CPAR	CENT PARA	05H	04H
PRY	PAL R-Y BLACK LEVEL	08H	←	VSC	V-S CORRECTION	09H	←
PBY	PAL B-Y BLACK LEVEL	08H	←				

Table-2

【 DESIGN MODE 】

ADJUSTING ITEMS AND DATAS IN THE DESIGN MODE:

Item	Name of adjustment	Preset Data	Data	Remarks
* There are no adjustments of the design mode.				

Table-3

LOCATION OF CONTROLS

Front

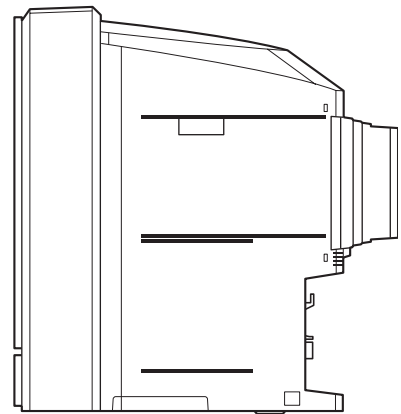
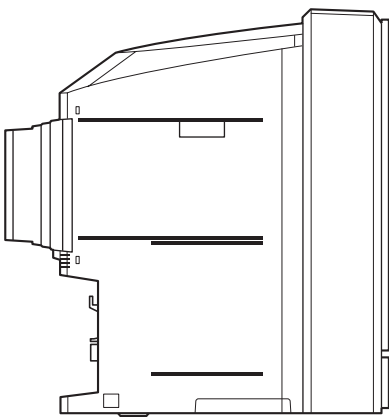
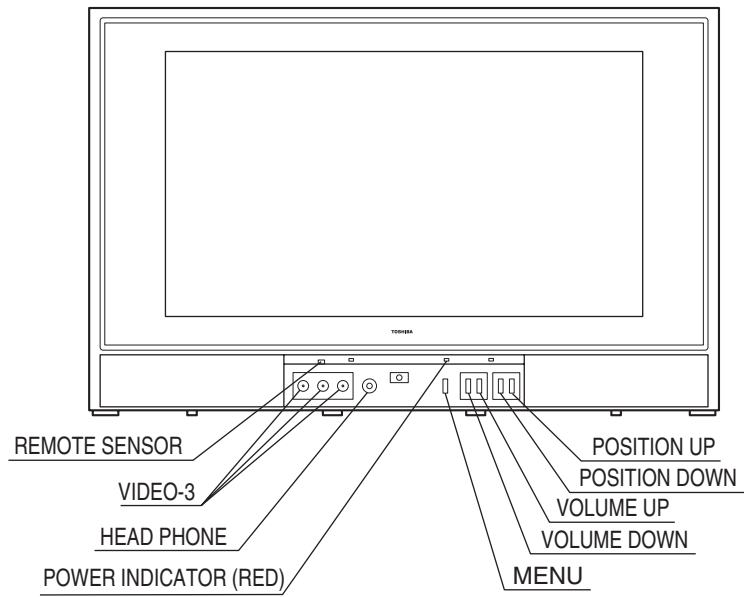

Rear terminals

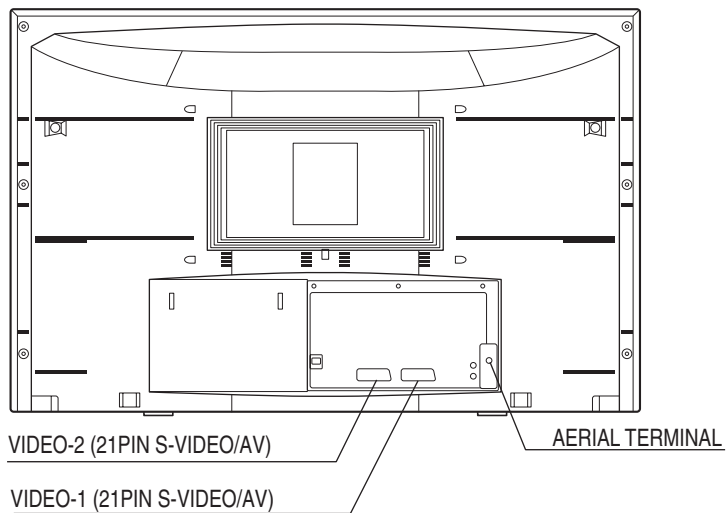

Remote Controller

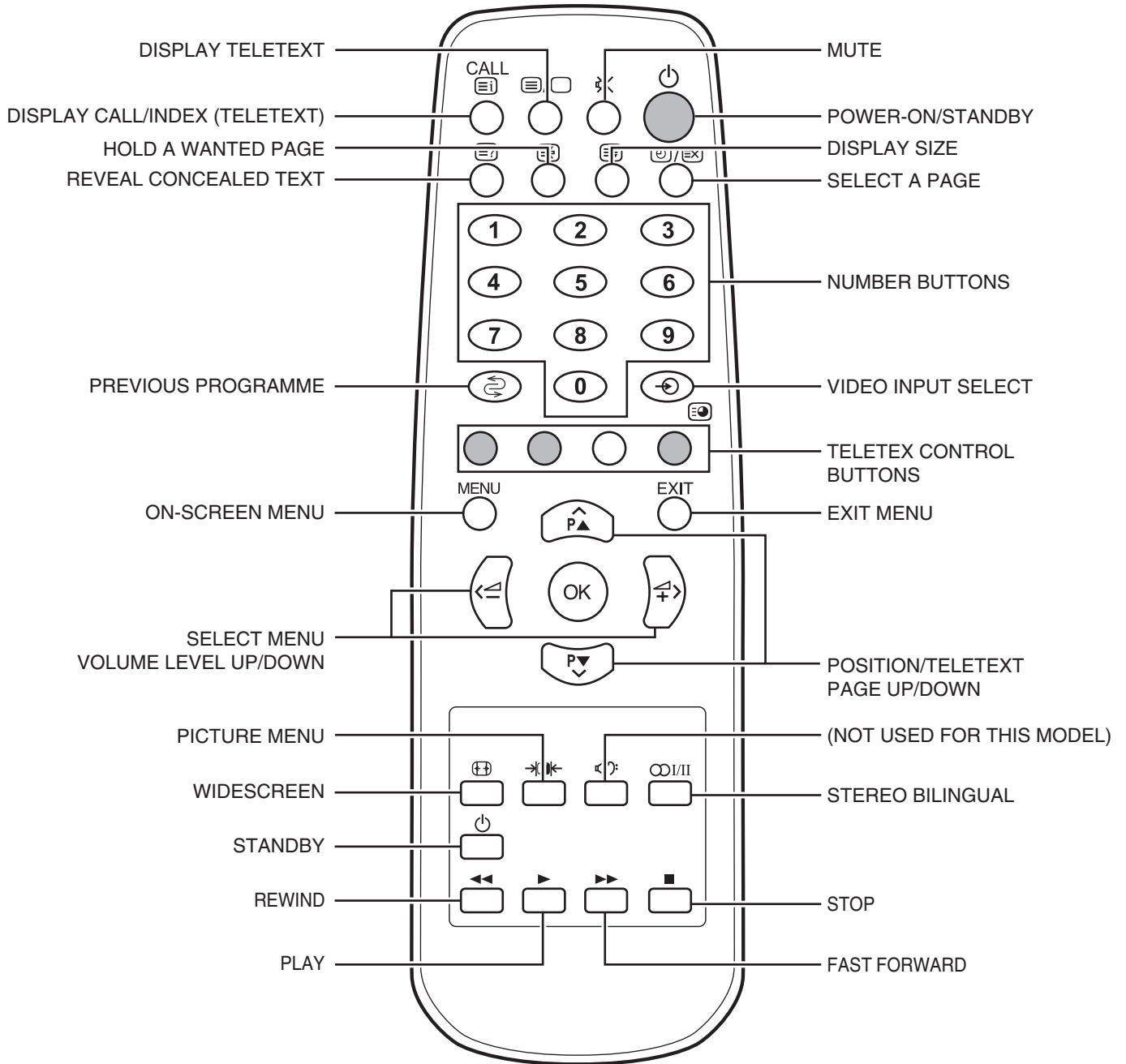

CHASSIS AND CABINET REPLACEMENT PARTS LIST

WARNING: BEFORE SERVICING THIS CHASSIS, READ THE "X-RAY RADIATION PRECAUTION", "SAFETY PRECAUTION" AND "PRODUCT SAFETY NOTICE" ON PAGE 3 OF THIS MANUAL.

CAUTION: The international hazard symbols " " in the schematic diagram and the parts list designate components which have special characteristics important for safety and should be replaced only with types identical to those in the original circuit or specified in the parts list. The mounting position of replacements is to be identical with originals. Before replacing any of these components, read carefully the PRODUCT SAFETY NOTICE. Do not degrade the safety of the receiver through improper servicing.

NOTICE:

- The part number must be used when ordering parts, in order to assist in processing, be sure to include the Model number and Description.
- The PC board assembly with * mark is no longer available after the end of the production.

Model : 28Z33B/32Z33B

Capacitors CD : Ceramic Disk PF : Plastic Film EL : Electrolytic
 Resistors CF : Carbon Film CC : Carbon Composition MF : Metal Film
 OMF : Oxide Metal Film VR : Variable Resistor FR : Fusible Resistor
 (All CD and PF capacitors are ±5%, 50V and all resistors, ±5%, 1/6W unless otherwise noted.)

SPECIFIC INFORMATIONS

Location No.	Parts No.	Description
#1 :	[28Z33B]	
#2 :	[32Z33B]	
CAPACITORS		
C101	24797229	ELECTROLYTIC, 50V 2.2UF M
C102	24109103	CERAMIC CHIP, 50V B 0.01UF K
C103	24793221	ELECTROLYTIC, 10V 220UF M
C104	24109103	CERAMIC CHIP, 50V B 0.01UF K
C105	24797100	ELECTROLYTIC, 50V 10UF M
C106	24109102	CERAMIC CHIP, 50V B 1000PF K
C107	24109103	CERAMIC CHIP, 50V B 0.01UF K
C108	24794101	ELECTROLYTIC, 16V 100UF M
C109	24109103	CERAMIC CHIP, 50V B 0.01UF K
C110	24109103	CERAMIC CHIP, 50V B 0.01UF K
C111	24109103	CERAMIC CHIP, 50V B 0.01UF K
C112	24503049	PLASTIC FILM, 63V 0.47UF J
C113	24109103	CERAMIC CHIP, 50V B 0.01UF K
C114	24109103	CERAMIC CHIP, 50V B 0.01UF K
C115	24109103	CERAMIC CHIP, 50V B 0.01UF K
C116	24109103	CERAMIC CHIP, 50V B 0.01UF K
C118	24794101	ELECTROLYTIC, 16V 100UF M
C119	24793101	ELECTROLYTIC, 10V 100UF M
C120	24109103	CERAMIC CHIP, 50V B 0.01UF K
C121	24109103	CERAMIC CHIP, 50V B 0.01UF K
C122	24109103	CERAMIC CHIP, 50V B 0.01UF K
C123	24100102	CERAMIC CHIP, 50V F 1000PF Z
C124	24797478	ELECTROLYTIC, 50V 0.47UF M
C125	24669479	ELECTROLYTIC, 50V 4.7UF M 3A
C126	24590472	PLASTIC FILM, 50V 4700PF J
C127	24797478	ELECTROLYTIC, 50V 0.47UF M
C128	24794100	ELECTROLYTIC, 16V 10UF M
C129	24794100	ELECTROLYTIC, 16V 10UF M
C130	24109103	CERAMIC CHIP, 50V B 0.01UF K
C140	24109103	CERAMIC CHIP, 50V B 0.01UF K
C160	24567224	PLASTIC FILM, 50V 0.22UF J
C204	24797479	ELECTROLYTIC, 50V 4.7UF M
C205	24092538	CERAMIC CHIP, 10V F 1UF Z
C206	24794101	ELECTROLYTIC, 16V 100UF M
C214	24503047	PLASTIC FILM, 63V 0.33UF J
C221	24105100	CERAMIC CHIP, 50V CH 10PF D
C222	24105100	CERAMIC CHIP, 50V CH 10PF D
C223	24105100	CERAMIC CHIP, 50V CH 10PF D
C302	24214471	CERAMIC DISC, 500V B 470PF K
C303	24214471	CERAMIC DISC, 500V B 470PF K
C304	24503041	PLASTIC FILM, 63V 0.1UF J
C305	24667222	ELECTROLYTIC, 25V 2200UF M 3A

Location No.	Parts No.	Description
C307	24503049	PLASTIC FILM, 63V 0.47UF J
C310	24667222	ELECTROLYTIC, 25V 2200UF M 3A
C311	24669221	ELECTROLYTIC, 50V 220UF M 3A
C314	24092730	CERAMIC CHIP, 16V B 0.1UF K
C331	24590103	PLASTIC FILM, 50V 0.01UF J
C360	#1 24503041	PLASTIC FILM, 63V 0.1UF J
C366	24082049	PLASTIC FILM, 100V 47000PF J
C370	24794100	ELECTROLYTIC, 16V 10UF M
C376	24109123	CERAMIC CHIP CK73B 50V 12000PF K
C377	24590392	PLASTIC FILM CQ922M 50V 3900PF J
C410	24214471	CERAMIC DISC, 500V B 470PF K
C413	24214821	CERAMIC DISC, 500V B 820PF K
C416	24678010	ELECTROLYTIC, 200V 1UF M 3A
C417	24214391	CERAMIC DISC, 500V B 390PF K
C420	24794101	ELECTROLYTIC, 16V 100UF M
C421	24232103	CERAMIC DISC, 50V F 0.01UF Z
C423	24829433	PLASTIC FILM, 400V 0.043UF J
C430	#1 24820562	PLASTIC FILM, 630V 5600PF J
	#2 24820822	PLASTIC FILM, 630V 8200PF J
C431	24232103	CERAMIC DISC, 50V F 0.01UF Z
△ C442	#1 24503297	PLASTIC FILM CF92 T 315V R27UF J
	#2 24503295	PLASTIC FILM CF92 T 315V R22UF J
△ C443	#1 24503278	PLASTIC FILM CF92 T 1500VH 8700PF H
	#2 24503228	PLASTIC FILM, 1500VH 6800PF H
△ C444	#1 24503147	PLASTIC FILM CF92 T 1500VH 8200PF H
	#2 24503228	PLASTIC FILM, 1500VH 6800PF H
C445	24828473	PLASTIC FILM, 200V 0.047UF J
C446	24679330	ELECTROLYTIC, 250V 33UF M 3A
C447	#1 24829203	PLASTIC FILM, 400V 20000PF J
	#2 24829273	PLASTIC FILM, 400V 0.027UF J
C448	24073118	ELECTROLYTIC, 160V 33UF M
C461	24591102	PLASTIC FILM, 50V 1000PF J
C464	24073124	100V 10U TOKUSHU 100YXG10MCA10X20
C466	24820273	PLASTIC FILM, 630V 27000PF J
C470	24794101	ELECTROLYTIC, 16V 100UF M
C472	24503049	PLASTIC FILM, 63V 0.47UF J
C473	24073081	ELECTROLYTIC, 50V 1.0UF M 3A
C483	#1 24590472	PLASTIC FILM, 50V 4700PF J
	#2 24590123	PLASTIC FILM, 50V 0.012UF J
C484	#1 24082260	PLASTIC FILM, 100V 4700PF J
	#2 24082257	PLASTIC FILM CQ922 M 100V 2700PF J
C501	24100104	CERAMIC CHIP, 25V F 0.1UF Z
C502	24092743	CERAMIC CHIP, 10V F 0.47UF Z
C503	24794470	ELECTROLYTIC, 16V 47UF M
C504	24109103	CERAMIC CHIP, 50V B 0.01UF K
C511	24100104	CERAMIC CHIP, 25V F 0.1UF Z

Location No.	Parts No.	Descriptiopn
C512	24100104	CERAMIC CHIP, 25V F 0.1UF Z
C513	24100104	CERAMIC CHIP, 25V F 0.1UF Z
C514	24794101	ELECTROLYTIC, 16V 100UF M
C516	24105110	CERAMIC CHIP, 50V CH 11PF J
C517	24092734	CERAMIC CHIP, 16V F 0.22UF Z
C522	24109103	CERAMIC CHIP, 50V B 0.01UF K
C524	24109103	CERAMIC CHIP, 50V B 0.01UF K
C526	24109222	CERAMIC CHIP, 50V B 2200PF K
C540	24100104	CERAMIC CHIP, 25V F 0.1UF Z
C541	24100104	CERAMIC CHIP, 25V F 0.1UF Z
C542	24100104	CERAMIC CHIP, 25V F 0.1UF Z
C601	24669479	ELECTROLYTIC, 50V 4.7UF M 3A
C602	24669479	ELECTROLYTIC, 50V 4.7UF M 3A
C603	24591561	PLASTIC FILM, 50V 560PF J
C604	24591561	PLASTIC FILM, 50V 560PF J
C605	24669100	ELECTROLYTIC, 50V 10UF M 3A
C606	24669100	ELECTROLYTIC, 50V 10UF M 3A
C607	24667470	ELECTROLYTIC, 25V 47UF M 3A
C608	24667470	ELECTROLYTIC, 25V 47UF M 3A
C609	24667470	ELECTROLYTIC, 25V 47UF M 3A
C611	24109102	CERAMIC CHIP, 50V B 1000PF K
C612	24668102	ELECTROLYTIC, 35V 1000UF M 3A
C613	24503042	PLASTIC FILM, 63V 0.12UF J
C614	24503042	PLASTIC FILM, 63V 0.12UF J
C615	24668102	ELECTROLYTIC, 35V 1000UF M 3A
C616	24668102	ELECTROLYTIC, 35V 1000UF M 3A
C618	24669479	ELECTROLYTIC, 50V 4.7UF M 3A
C619	24794471	ELECTROLYTIC, 16V 470UF M
C639	24793101	ELECTROLYTIC, 10V 100UF M
C667	24212102	CERAMIC DISC, 50V B 1000PF K
C668	24212102	CERAMIC DISC, 50V B 1000PF K
C669	24797330	ELECTROLYTIC, 50V 33UF M
C670	24797330	ELECTROLYTIC, 50V 33UF M
△ C801	24503507	PLASTIC FILM, AC275V 0.22UF K
△ C802	24503507	PLASTIC FILM, AC275V 0.22UF K
C805	24092281	CERAMIC DISC, AC250V E 4700PF
C806	24092281	CERAMIC DISC, AC250V E 4700PF
C807	24503049	PLASTIC FILM, 63V 0.47UF J
C808	24667101	ELECTROLYTIC, 25V 100UF M 3A
C809	24668339	ELECTROLYTIC, 35V 3.3UF M 3A
C810	24086059	ELECTROLYTIC, 400V 270UF M 3D
C812	24503041	PLASTIC FILM , 63V 0.1UF J
△ C813	24092555	CERAMIC DISC, AC250V E 1000PF M
△ C814	24092555	CERAMIC DISC, AC250V E 1000PF M
C817	24092339	CERAMIC DISC, 2KV 330PF K
C818	24095931	PLASTIC FILM, 1250VH 2200PF J
C819	24676220	ELECTROLYTIC, 100V 22UF M 3A
C821	24214471	CERAMIC DISC, 500V B 470PF K
C823	24214471	CERAMIC DISC, 500V B 470PF K
C829	24212272	CERAMIC DISC, 50V B 2700PF K
C840	24503049	PLASTIC FILM, 63V 0.47UF J
C841	24503047	PLASTIC FILM, 63V 0.33UF J
C842	24797470	ELECTROLYTIC, 50V 47UF M
C860	24794470	ELECTROLYTIC, 16V 47UF M
C861	24793470	ELECTROLYTIC CE04G 10V 47UF M
C884	24086916	ELECTROLYTIC, 160V 330UF M 3D
C885	24214471	CERAMIC DISC, 500V B 470PF K
C887	24214471	CERAMIC DISC, 500V B 470PF K
C889	24669222	ELECTROLYTIC, 50V 2200UF M 3A
C890	24667102	ELECTROLYTIC, 25V 1000UF M 3A
C893	24092337	CERAMIC DISC, 2KV 220PF K
C895	24669101	ELECTROLYTIC, 50V 100UF M 3A
C896	24214471	CERAMIC DISC, 500V B 470PF K
C898	24503045	PLASTIC FILM, 63V 0.22UF J
C902	24092349	CERAMIC DISC, 2KV R 2200PF K
C904	24436561	CERAMIC DISC, 50V SL 560PF J
C905	24436561	CERAMIC DISC, 50V SL 560PF J
C907	24436561	CERAMIC DISC, 50V SL 560PF J
C909	24679100	ELECTROLYTIC, 250V 10UF M 3A
C910	24797478	ELECTROLYTIC, 50V 0.47UF M
C911	24794100	ELECTROLYTIC, 16V 10UF M
C912	24073042	ELECTROLYTIC, 16V 1000UF M 3A
C913	24794101	ELECTROLYTIC, 16V 100UF M
C914	24212103	CERAMIC DISC, 50V B 10000PF K
C915	24092398	CERAMIC DISC, 25V 0.1UF Z
C930	24214101	CERAMIC DISC, 500V B 100PF K

Location No.	Parts No.	Descriptiopn
C931	24214101	CERAMIC DISC, 500V B 100PF K
C4401	24109153	CERAMIC CHIP, 50V B 0.015UF K
C4402	24797229	ELECTROLYTIC, 50V 2.2UF M
C4403	24092730	CERAMIC CHIP, 16V B 0.1UF K
C4404	24794470	ELECTROLYTIC, 16V 47UF M
C4406	24092730	CERAMIC CHIP, 16V B 0.1UF K
C4412	24109473	CERAMIC CHIP, 25V B 0.047UF K
C4490 #1	24082908	PLASTIC FILM, 315V 0.12UF J
#2	24082906	PLASTIC FILM, 315V 0.1UF J
C5070	24109103	CERAMIC CHIP, 50V B 0.01UF K
C5100	24794101	ELECTROLYTIC, 16V 100UF M
CA01	24100104	CERAMIC CHIP, 25V F 0.1UF Z
CA02	24100104	CERAMIC CHIP, 25V F 0.1UF Z
CA03	24100104	CERAMIC CHIP, 25V F 0.1UF Z
CA04	24100104	CERAMIC CHIP, 25V F 0.1UF Z
CA06	24100104	CERAMIC CHIP, 25V F 0.1UF Z
CA07	24105560	CERAMIC CHIP, 50V CH 56PF J
CA08	24105560	CERAMIC CHIP, 50V CH 56PF J
CA09	24109103	CERAMIC CHIP, 50V B 0.01UF K
CA10	24100104	CERAMIC CHIP, 25V F 0.1UF Z
CA11	24794100	ELECTROLYTIC, 16V 10UF M
CA12	24092789	CERAMIC CHIP CK73B 6.3V 1UF K
CA13	24109103	CERAMIC CHIP, 50V B 0.01UF K
CA14	24794100	ELECTROLYTIC, 16V 10UF M
CA15	24794100	ELECTROLYTIC, 16V 10UF M
CA16	24794100	ELECTROLYTIC, 16V 10UF M
CA17	24092730	CERAMIC CHIP, 16V B 0.1UF K
CA18	24793470	ELECTROLYTIC CE04G 10V 47UF M
CB01	24797010	ELECTROLYTIC, 50V 1UF M
CB02	24105181	CERAMIC CHIP, 50V CH 180PF J
CB03	24794330	ELECTROLYTIC, 16V 33UF M
CB04	24109472	CERAMIC CHIP, 50V B 4700PF K
CB05	24105561	CERAMIC CHIP, 50V CH 560PF J
CB21	24503041	PLASTIC FILM , 63V 0.1UF J
CB22	24203470	ELECTROLYTIC, 16V 47UF M 7L 3A
CC01	24232103	CERAMIC DISC, 50V F 0.01UF Z
CC09	24109103	CERAMIC CHIP, 50V B 0.01UF K
CC26	24109103	CERAMIC CHIP, 50V B 0.01UF K
CC27	24109103	CERAMIC CHIP, 50V B 0.01UF K
CC30	24105470	CERAMIC CHIP, 50V CH 47PF J
CC31	24105470	CERAMIC CHIP, 50V CH 47PF J
CC60	24109223	CERAMIC CHIP, 25V B 0.022UF K
CC61	24109223	CERAMIC CHIP, 25V B 0.022UF K
CC62	24109102	CERAMIC CHIP, 50V B 1000PF K
CC63	24109102	CERAMIC CHIP, 50V B 1000PF K
CC64	24109102	CERAMIC CHIP, 50V B 1000PF K
CC65	24109102	CERAMIC CHIP, 50V B 1000PF K
CC66	24109102	CERAMIC CHIP, 50V B 1000PF K
CC67	24109102	CERAMIC CHIP, 50V B 1000PF K
CC68	24100104	CERAMIC CHIP, 25V F 0.1UF Z
CS01	24797229	ELECTROLYTIC, 50V 2.2UF M
CS02	24797229	ELECTROLYTIC, 50V 2.2UF M
CS03	24797229	ELECTROLYTIC, 50V 2.2UF M
CS04	24797229	ELECTROLYTIC, 50V 2.2UF M
CS05	24797229	ELECTROLYTIC, 50V 2.2UF M
CS06	24797229	ELECTROLYTIC, 50V 2.2UF M
CS07	24797229	ELECTROLYTIC, 50V 2.2UF M
CS08	24797229	ELECTROLYTIC, 50V 2.2UF M
CS18	24794100	ELECTROLYTIC, 16V 10UF M
CS19	24794100	ELECTROLYTIC, 16V 10UF M
CS20	24797478	ELECTROLYTIC, 50V 0.47UF M
CV02	24100104	CERAMIC CHIP, 25V F 0.1UF Z
CV03	24100104	CERAMIC CHIP, 25V F 0.1UF Z
CV04	24100104	CERAMIC CHIP, 25V F 0.1UF Z
CV05	24109103	CERAMIC CHIP, 50V B 0.01UF K
CV06	24100104	CERAMIC CHIP, 25V F 0.1UF Z
CV08	24763221	ELECTROLYTIC, 16V 220UF M
CV12	24100104	CERAMIC CHIP, 25V F 0.1UF Z
CV23	24203101	ELECTROLYTIC, 16V 100UF M 7L 3A
CV24	24100104	CERAMIC CHIP, 25V F 0.1UF Z
CV25	24794220	ELECTROLYTIC, 16V 22UF M
CV26	24109473	CERAMIC CHIP, 25V B 0.047UF K
CV27	24203101	ELECTROLYTIC, 16V 100UF M 7L 3A
CV28	24100104	CERAMIC CHIP, 25V F 0.1UF Z
CV46	24212332	CERAMIC DISC, 50V B 3300PF K
CV47	24212332	CERAMIC DISC, 50V B 3300PF K

SPECIFIC INFORMATIONS

Location No.	Parts No.	Descriptiopn
RESISTORS		
R101	24553223	OXIDE METAL FILM, 1W 22K OHM J
R102	24011103	CHIP, METAL FILM, 1/20W 10K OHM J
R103	24011433	CHIP, METAL FILM, 1/20W 43K OHM J
R104	24011271	CHIP, METAL FILM, 1/20W 270 OHM J
R105	24000445	CHIP JUMPER, 1608TYPE
R106	24011682	CHIP, METAL FILM, 1/20W 6.8K OHM J
R107	24011122	CHIP, METAL FILM, 1/20W 1.2K OHM J
R108	24011471	CHIP, METAL FILM, 1/20W 470 OHM J
R109	24011102	CHIP, METAL FILM, 1/20W 1K OHM J
R110	24872360	CHIP, METAL FILM, 1/16W 36 OHM J
R112	24011562	CHIP, METAL FILM, 1/20W 5.6K OHM J
R113	24011102	CHIP, METAL FILM, 1/20W 1K OHM J
R114	24011471	CHIP, METAL FILM, 1/20W 470 OHM J
R116	24011682	CHIP, METAL FILM, 1/20W 680 OHM J
R117	24872360	CHIP, METAL FILM, 1/16W 36 OHM J
R122	24011221	CHIP, METAL FILM, 1/20W 220 OHM J
R123	24011101	CHIP, METAL FILM, 1/20W 100 OHM J
R124	24011331	CHIP, METAL FILM, 1/20W 330 OHM J
R125	24011101	CHIP, METAL FILM, 1/20W 100 OHM J
R126	24011101	CHIP, METAL FILM, 1/20W 100 OHM J
R127	24011102	CHIP, METAL FILM, 1/20W 1K OHM J
R128	24011102	CHIP, METAL FILM, 1/20W 1K OHM J
R129	24011272	CHIP, 1/20W 2.7K OHM J
R130	24011101	CHIP, METAL FILM, 1/20W 100 OHM J
R131	24011221	CHIP, METAL FILM, 1/20W 220 OHM J
R132	24011684	CHIP, METAL FILM, 1/20W 680K OHM J
R135	24000445	CHIP JUMPER, 1608TYPE
R204	24011473	CHIP, METAL FILM, 1/20W 47K OHM J
R208	24011683	CHIP, METAL FILM, 1/20W 68K OHM J @U902
	24366103	CARBON FILM, 1/6W 10K OHM J @U903A
R209	24011472	CHIP, METAL FILM, 1/20W 4.7K OHM J @U902
	24366103	CARBON FILM, 1/6W 10K OHM J @U903A
R211	24366623	CARBON FILM, 1/6W 62K OHM J
R216	24872103	CHIP, METAL FILM, 1/16W 10K OHM J
R217	24366392	CARBON FILM, 1/6W 3.9K OHM J
R218	24011101	CHIP, METAL FILM, 1/20W 100 OHM J @U902
	24366223	CARBON FILM, 1/6W 22K OHM J @U903A
R219	24011101	CHIP, METAL FILM, 1/20W 100 OHM J @U902
	24366203	CARBON FILM, 1/6W 20K OHM J @U903A
R220	24011101	CHIP, METAL FILM, 1/20W 100 OHM J
R227	#1 24366333	CARBON FILM, 1/6W 33K OHM J
	#2 24366303	CARBON FILM, 1/6W 30K OHM J
R271	24011103	CHIP, METAL FILM, 1/20W 10K OHM J
R272	24011103	CHIP, METAL FILM, 1/20W 10K OHM J
R300	#1 24000525	METAL FILM, 1/4W 4.7K OHM F
	#2 24367472	CARBON FILM, 1/6W 4.7K OHM G
R301	#1 24367681	CARBON FILM, 1/6W 680 OHM G
	#2 24367472	CARBON FILM, 1/6W 4.7K OHM G
R302	#1 24000525	METAL FILM, 1/4W 4.7K OHM F
	#2 24367472	CARBON FILM, 1/6W 4.7K OHM G
R305	24322109	OXIDE METAL FILM, 1W 1 OHM J
R321	24011104	CHIP, METAL FILM, 1/20W 100K OHM J @U902
	24366224	CARBON FILM, 1/6W 220K OHM J @U903A
R322	24011333	CHIP, METAL FILM, 1/20W 33K OHM J @U902
	24366274	CARBON FILM, 1/6W 270K OHM J @U903A
R325	24011334	CHIP, METAL FILM, 1/20W 330K OHM J
R326	24338109	OXIDE METAL FILM, 1W 1 OHM J
R327	24338109	OXIDE METAL FILM, 1W 1 OHM J
R336	#1 24382181	OXIDE METAL FILM, 1W 180 OHM J
	#2 24382271	OXIDE METAL FILM, 1W 270 OHM J
R337	#1 24000525	METAL FILM, 1/4W 4.7K OHM F
	#2 24367472	CARBON FILM, 1/6W 4.7K OHM G
R362	24011823	CHIP, METAL FILM, 1/20W 82K OHM J
R363	24011223	CHIP, METAL FILM, 1/20W 22K OHM J
R364	24011223	CHIP, METAL FILM, 1/20W 22K OHM J
R365	24011223	CHIP, METAL FILM, 1/20W 22K OHM J
R366	24011472	CHIP, METAL FILM, 1/20W 4.7K OHM J
R367	24011471	CHIP, METAL FILM, 1/20W 470 OHM J
R368	24011102	CHIP, METAL FILM, 1/20W 1K OHM J
R369	24011223	CHIP, METAL FILM, 1/20W 22K OHM J
R370	24366822	CARBON FILM, 1/6W 8.2K OHM J
R371	24366103	CARBON FILM, 1/6W 10K OHM J
R372	24366220	CARBON FILM, 1/6W 22 OHM J
R373	24366103	CARBON FILM, 1/6W 10K OHM J
R374	24011103	CHIP, METAL FILM, 1/20W 10K OHM J

Location No.	Parts No.	Descriptiopn
R375	24011223	CHIP, METAL FILM, 1/20W 22K OHM J
R376	24011104	CHIP, METAL FILM, 1/20W 100K OHM J
R377	24011563	CHIP, METAL FILM, 1/20W 56K OHM J
R378	24011822	CHIP, METAL FILM, 1/20W 8.2K OHM J
R379	24011103	CHIP, METAL FILM, 1/20W 10K OHM J
R400	24946561	CARBON COMPOSITION, 1/2W 560 OHM K
R401	24946223	CARBON COMPOSITION GF 1/2W 22K K
R405	24553682	OXIDE METAL FILM, 1W 6.8K OHM J
R410	24366271	CARBON FILM, 1/6W 270 OHM J
R411	24366331	CARBON FILM, 1/6W 330 OHM J
R414	24531560	FUSIBLE, 1/2W 56 OHM J
R415	24553472	OXIDE METAL FILM, 1W 4.7K OHM J
R417	#1 24510512	CERAMIC COVERED, 5W 5.1K OHM J
	#2 24510562	CERAMIC COVERED, 5W 5.6K OHM J
R425	24366561	CARBON FILM, 1/6W 560 OHM J
R426	24366751	CARBON FILM, 1/6W 750 OHM J
R427	24366392	CARBON FILM, 1/6W 3.9K OHM J
R428	24366561	CARBON FILM, 1/6W 560 OHM J
R431	24366103	CARBON FILM, 1/6W 10K OHM J
R432	24366473	CARBON FILM, 1/6W 47K OHM J
R433	24366681	CARBON FILM, 1/6W 680 OHM J
R434	24366472	CARBON FILM, 1/6W 4.7K OHM J
R441	24532102	FUSIBLE, 1W 1K OHM J
R445	24546229	FUSIBLE, 1/2W 2.2 OHM J
R451	24011123	CHIP, METAL FILM, 1/20W 12K OHM J
R452	24011472	CHIP, METAL FILM, 1/20W 4.7K OHM J
R462	24366103	CARBON FILM, 1/6W 10K OHM J
R463	24366152	CARBON FILM, 1/6W 1.5K OHM J
R464	24366102	CARBON FILM, 1/6W 1K OHM J
R465	24011682	CHIP, METAL FILM, 1/20W 6.8K OHM J
R469	24338569	METAL FILM 1W 5R6 J
R470	24338568	OXIDE METAL FILM, 1W 0.56 OHM J
R471	24381271	OXIDE METAL FILM, 1/2W 270 OHM J
R472	24366101	CARBON FILM, 1/6W 100 OHM J
R473	24366183	CARBON FILM, 1/6W 18K OHM J
R474	24376393	CARBON FILM, 1/2W 39K OHM J
R476	24366471	CARBON FILM, 1/6W 470 OHM J
R477	24366102	CARBON FILM, 1/6W 1K OHM J
R479	24381680	OXIDE METAL FILM, 1/2W 68 OHM J
R483	#1 24366104	CARBON FILM, 1/6W 100K OHM J
	#2 24366224	CARBON FILM, 1/6W 220K OHM J
R484	#1 24366823	CARBON FILM, 1/6W 82K OHM J
	#2 24366683	CARBON FILM, 1/6W 68K OHM J
R490	24366101	CARBON FILM, 1/6W 100 OHM J
R491	24366101	CARBON FILM, 1/6W 100 OHM J
R492	24366332	CARBON FILM, 1/6W 3.9K OHM J
R503	24366331	CARBON FILM, 1/6W 330 OHM J
R506	24011473	CHIP, METAL FILM, 1/20W 47K OHM J
R511	24011102	CHIP, METAL FILM, 1/20W 1K OHM J
R512	24011102	CHIP, METAL FILM, 1/20W 1K OHM J
R514	24011102	CHIP, METAL FILM, 1/20W 1K OHM J
R515	24011102	CHIP, METAL FILM, 1/20W 1K OHM J
R516	24011102	CHIP, METAL FILM, 1/20W 1K OHM J
R517	24011102	CHIP, METAL FILM, 1/20W 1K OHM J
R521	24011222	CHIP, METAL FILM, 1/20W 2.2K OHM J
R522	24011222	CHIP, METAL FILM, 1/20W 2.2K OHM J
R523	24011222	CHIP, METAL FILM, 1/20W 2.2K OHM J
R601	24011103	CHIP, METAL FILM, 1/20W 10K OHM J
R602	24011103	CHIP, METAL FILM, 1/20W 10K OHM J
R603	24011123	CHIP, METAL FILM, 1/20W 12K OHM J
R604	24011123	CHIP, METAL FILM, 1/20W 12K OHM J
R607	24011223	CHIP, METAL FILM, 1/20W 22K OHM J
R608	24011223	CHIP, METAL FILM, 1/20W 22K OHM J
R609	24366229	CARBON FILM, 1/6W 2.2 OHM J
R610	24366229	CARBON FILM, 1/6W 2.2 OHM J
R611	24011104	CHIP, METAL FILM, 1/20W 100K OHM J
R618	24011103	CHIP, METAL FILM, 1/20W 10K OHM J
R619	24011224	CHIP, METAL FILM, 1/20W 220K OHM J
R661	24552221	OXIDE METAL FILM, 1/2W 220 OHM J
R662	24552221	OXIDE METAL FILM, 1/2W 220 OHM J
△ R801	24004716	METAL GLAZE 1/2W 2R2M J
R803	24553683	OXIDE METAL FILM, 1W 68K OHM J
R805	24366221	CARBON FILM, 1/6W 220 OHM J
△ R808	24019484	THERMISTOR, PTC, AC265 4R5A
R810	24366102	CARBON FILM, 1/6W 1K OHM J
R815	24366102	CARBON FILM, 1/6W 1K OHM J

Location No.	Parts No.	Descriptiopn
R818	24019463	METAL PLATE RK99 2W R22 J
R819	24310829	OXIDE METAL FILM, 1/2W 8.2 OHM J
R822	24552103	OXIDE METAL FILM, 1/2W 10K OHM J
R823	24552392	RESISTOR, OXIDE METAL FILM, 1/2W 3.9K OHM J
R827	24366681	CARBON FILM, 1/6W 680 OHM J
R828	24366821	CARBON FILM, 1/6W 820 OHM J
R829	24321129	OXIDE METAL FILM, 1/2W 1.2 OHM J
R840	24366101	CARBON FILM, 1/6W 100 OHM J
R842	24552562	OXIDE METAL FILM, 1/2W 5.6K OHM J
R843	24366331	CARBON FILM, 1/6W 330 OHM J
R847	24366472	CARBON FILM, 1/6W 4.7K OHM J
R850	24366103	CARBON FILM, 1/6W 10K OHM J
R851	24366471	CARBON FILM, 1/6W 470 OHM J
R852	24366225	CARBON FILM, 1/6W 2.2M OHM J
R865	24366332	CARBON FILM, 1/6W 3.3K OHM J
R868	24366472	CARBON FILM, 1/6W 4.7K OHM J
△ R899	24004718	METAL GLAZE 1/2W 8R2M J
R901	24376471	CARBON FILM, 1/2W 470 OHM J
R902	24376471	CARBON FILM, 1/2W 470 OHM J
R903	24376471	CARBON FILM, 1/2W 470 OHM J
R904	24366472	CARBON FILM, 1/6W 4.7K OHM J
R905	24366150	CARBON FILM, 1/6W 15 OHM J
R914	24366471	CARBON FILM, 1/6W 470 OHM J
R915	24366181	CARBON FILM, 1/6W 180 OHM J
R916	24366271	CARBON FILM, 1/6W 270 OHM J
R917	24366681	CARBON FILM, 1/6W 680 OHM J
R918	24366470	CARBON FILM, 1/6W 47 OHM J
R920	#1 24000929	FUSIBLE, 2W 1.5 OHM J
	#2 24000910	FUSIBLE, 1W 3.3 OHM J
R921	24366471	CARBON FILM, 1/6W 470 OHM J
R922	24366181	CARBON FILM, 1/6W 180 OHM J
R924	24366470	CARBON FILM, 1/6W 47 OHM J
R925	24366681	CARBON FILM, 1/6W 680 OHM J
R928	24366471	CARBON FILM, 1/6W 470 OHM J
R929	24366181	CARBON FILM, 1/6W 180 OHM J
R930	24366470	CARBON FILM, 1/6W 47 OHM J
R932	24366102	CARBON FILM, 1/6W 1K OHM J
R934	24366271	CARBON FILM, 1/6W 270 OHM J
R935	24366102	CARBON FILM, 1/6W 1K OHM J
R936	24545150	FUSIBLE, 1/4W 15 OHM J
R937	24366681	CARBON FILM, 1/6W 680 OHM J
R945	24366271	CARBON FILM, 1/6W 270 OHM J
R946	24366271	CARBON FILM, 1/6W 270 OHM J
R960	24383153	OXIDE METAL FILM, 2W 15K OHM J
R963	24383153	OXIDE METAL FILM, 2W 15K OHM J
R966	24383153	OXIDE METAL FILM, 2W 15K OHM J
R977	24366102	CARBON FILM, 1/6W 1K OHM J
R980	24366471	CARBON FILM, 1/6W 470 OHM J
R992	24366150	CARBON FILM, 1/6W 15 OHM J
R4403	24011392	CHIP, METAL FILM, 1/20W 3.9K OHM J
R4404	24011101	CHIP, METAL FILM, 1/20W 100 OHM J
R4409	24011103	CHIP, METAL FILM, 1/20W 10K OHM J
R4490	24382102	OXIDE METAL FILM, 1W 1K OHM J
R4491	24366392	CARBON FILM, 1/6W 3.9K OHM J
R4492	24366103	CARBON FILM, 1/6W 10K OHM J
R4493	24382104	OXIDE METAL FILM, 1W 100K OHM J
R4495	24366473	CARBON FILM, 1/6W 47K OHM J
R4600	#1 24367103	CARBON FILM, 1/6W 10K OHM G
	#2 24000636	METAL FILM, 1/4W 13K OHM F
R4601	#1 24003898	METAL FILM, 1/4W 3.3K OHM J
	#2 24000370	METAL FILM, 1/4W 3.3K OHM F
R4602	#1 24000362	METAL FILM, 1/4W 1.5K OHM F
	#2 24000364	METAL FILM, 1/4W 1.8K OHM F
R4603	24366103	CARBON FILM, 1/6W 10K OHM J
R4604	24366332	CARBON FILM, 1/6W 3.3K OHM J
R4605	24366102	CARBON FILM, 1/6W 1K OHM J
R4606	24366102	CARBON FILM, 1/6W 1K OHM J
R4607	24366103	CARBON FILM, 1/6W 10K OHM J
R4608	24366103	CARBON FILM, 1/6W 10K OHM J
R4609	24366682	CARBON FILM, 1/6W 6.8K OHM J
R4610	24366622	CARBON FILM, 1/6W 6.2K OHM J
R4611	24366102	CARBON FILM, 1/6W 1K OHM J
R4612	#1 24000527	METAL FILM, 1/4W 5.6K OHM F
	#2 24000372	METAL FILM, 1/4W 3.9K OHM F
RA03	24011102	CHIP, METAL FILM, 1/20W 1K OHM J
RA04	24011102	CHIP, METAL FILM, 1/20W 1K OHM J

Location No.	Parts No.	Descriptiopn
RA05	24011103	CHIP, METAL FILM, 1/20W 10K OHM J
RA06	24011102	CHIP, METAL FILM, 1/20W 1K OHM J
RA07	24011103	CHIP, METAL FILM, 1/20W 10K OHM J
RA08	24011472	CHIP, METAL FILM, 1/20W 4.7K OHM J
RA09	24011103	CHIP, METAL FILM, 1/20W 10K OHM J
RA10	24011103	CHIP, METAL FILM, 1/20W 10K OHM J
RA11	24011103	CHIP, METAL FILM, 1/20W 10K OHM J
RA12	24011102	CHIP, METAL FILM, 1/20W 1K OHM J
RA13	24011102	CHIP, METAL FILM, 1/20W 1K OHM J
RA14	24011331	CHIP, METAL FILM, 1/20W 330 OHM J
RA15	24011472	CHIP, METAL FILM, 1/20W 4.7K OHM J
RA16	24011331	CHIP, METAL FILM, 1/20W 330 OHM J
RA17	24011102	CHIP, METAL FILM, 1/20W 1K OHM J
RA18	24000594	CHIP, 1/16W 12K OHM F
RA20	24000594	CHIP, 1/16W 12K OHM F
RA21	24011102	CHIP, METAL FILM, 1/20W 1K OHM J
RA22	24011224	CHIP, METAL FILM, 1/20W 220K OHM J
RA23	24011182	CHIP, METAL FILM, 1/20W 1.8K OHM J
RA24	24011182	CHIP, METAL FILM, 1/20W 1.8K OHM J
RA25	24011182	CHIP, METAL FILM, 1/20W 1.8K OHM J
RA26	24011103	CHIP, METAL FILM, 1/20W 10K OHM J
RA27	24011102	CHIP, METAL FILM, 1/20W 1K OHM J
RA28	24011102	CHIP, METAL FILM, 1/20W 1K OHM J
RA29	24011333	CHIP, METAL FILM, 1/20W 33K OHM J
RA30	24011103	CHIP, METAL FILM, 1/20W 10K OHM J
RA31	24011102	CHIP, METAL FILM, 1/20W 1K OHM J
RA32	24011101	CHIP, METAL FILM, 1/20W 100 OHM J
RA33	24011103	CHIP, METAL FILM, 1/20W 10K OHM J
RA34	24011101	CHIP, METAL FILM, 1/20W 100 OHM J
RA35	24011101	CHIP, METAL FILM, 1/20W 100 OHM J
RA36	24011472	CHIP, METAL FILM, 1/20W 4.7K OHM J
RA37	24011102	CHIP, METAL FILM, 1/20W 1K OHM J
RA38	24011472	CHIP, METAL FILM, 1/20W 4.7K OHM J
RA39	24011102	CHIP, METAL FILM, 1/20W 1K OHM J
RA40	24011182	CHIP, METAL FILM, 1/20W 1.8K OHM J
RA41	24011103	CHIP, METAL FILM, 1/20W 10K OHM J
RA42	24011101	CHIP, METAL FILM, 1/20W 100 OHM J
RA43	24011182	CHIP, METAL FILM, 1/20W 1.8K OHM J
RA44	24011182	CHIP, METAL FILM, 1/20W 1.8K OHM J
RA45	24011222	CHIP, METAL FILM, 1/20W 2.2K OHM J
RA46	24011222	CHIP, METAL FILM, 1/20W 2.2K OHM J
RA47	24011101	CHIP, METAL FILM, 1/20W 100 OHM J
RA48	24011101	CHIP, METAL FILM, 1/20W 100 OHM J
RA49	24011222	CHIP, METAL FILM, 1/20W 2.2K OHM J
RA50	24011102	CHIP, METAL FILM, 1/20W 1K OHM J
RA53	24011101	CHIP, METAL FILM, 1/20W 100 OHM J
RA54	24011103	CHIP, METAL FILM, 1/20W 10K OHM J
RA64	24011101	CHIP, METAL FILM, 1/20W 100 OHM J
RA65	24011101	CHIP, METAL FILM, 1/20W 100 OHM J
RA66	24011331	CHIP, METAL FILM, 1/20W 330 OHM J
RA67	24011331	CHIP, METAL FILM, 1/20W 330 OHM J
RA71	24366113	CARBON FILM, 1/6W 11K OHM J
RA72	24366512	CARBON FILM, 1/6W 5.1K OHM J
RA73	24366272	CARBON FILM, 1/6W 2.7K OHM J
RA84	24011103	CHIP, METAL FILM, 1/20W 10K OHM J
RA85	24011473	CHIP, METAL FILM, 1/20W 47K OHM J
RA86	24011332	CHIP, METAL FILM, 1/20W 3.3K OHM J
RB01	24011182	CHIP, METAL FILM, 1/20W 1.8K OHM J
RB02	24011474	CHIP, METAL FILM, 1/20W 470K OHM J
RB03	24011333	CHIP, METAL FILM, 1/20W 33K OHM J
RB04	24011123	CHIP, METAL FILM, 1/20W 12K OHM J @U902
	24366101	CARBON FILM, 1/6W 100 OHM J @U904A
RB05	24011392	CHIP, METAL FILM, 1/20W 3.9K OHM J @U902
	24366472	CARBON FILM, 1/6W 4.7K OHM J @U904A
RB06	24011392	CHIP, METAL FILM, 1/20W 3.9K OHM J @U902
	24366271	CARBON FILM, 1/6W 2.7K OHM J @U904A
RB07	24011223	CHIP, METAL FILM, 1/20W 22K OHM J
RB08	24011471	CHIP, METAL FILM, 1/20W 470 OHM J
RB22	24366470	CARBON FILM, 1/6W 47 OHM J
RB96	24011472	CHIP, METAL FILM, 1/20W 4.7K OHM J
RB97	24011472	CHIP, METAL FILM, 1/20W 4.7K OHM J
RC01	24011681	CHIP, METAL FILM, 1/20W 680 OHM J
RC02	24011681	CHIP, METAL FILM, 1/20W 680 OHM J
RC03	24011681	CHIP, METAL FILM, 1/20W 680 OHM J
RC04	24011681	CHIP, METAL FILM, 1/20W 680 OHM J
RR01	24011332	CHIP, METAL FILM, 1/20W 3.3K OHM J

Location No.	Parts No.	Descriptiopn
RR13	24011151	CHIP, METAL FILM, 1/20W 150 OHM J
RR14	24011151	CHIP, METAL FILM, 1/20W 150 OHM J
RR15	24011151	CHIP, METAL FILM, 1/20W 150 OHM J
RS03	24011562	CHIP, METAL FILM, 1/20W 5.6K OHM J
RS04	24011562	CHIP, METAL FILM, 1/20W 5.6K OHM J
RS05	24011562	CHIP, METAL FILM, 1/20W 5.6K OHM J
RS06	24011562	CHIP, METAL FILM, 1/20W 5.6K OHM J
RS07	24011562	CHIP, METAL FILM, 1/20W 5.6K OHM J
RS08	24011562	CHIP, METAL FILM, 1/20W 5.6K OHM J
RS09	24011562	CHIP, METAL FILM, 1/20W 5.6K OHM J
RS10	24011562	CHIP, METAL FILM, 1/20W 5.6K OHM J
RS13	24011101	CHIP, METAL FILM, 1/20W 100 OHM J
RS14	24011101	CHIP, METAL FILM, 1/20W 100 OHM J
RS23	24011104	CHIP, METAL FILM, 1/20W 100K OHM J
RS24	24011104	CHIP, METAL FILM, 1/20W 100K OHM J
RS25	24011104	CHIP, METAL FILM, 1/20W 100K OHM J
RS26	24011104	CHIP, METAL FILM, 1/20W 100K OHM J
RS49	24011271	CHIP, METAL FILM, 1/20W 270 OHM J
RS50	24011271	CHIP, METAL FILM, 1/20W 270 OHM J
RS51	24011104	CHIP, METAL FILM, 1/20W 100K OHM J
RS52	24011104	CHIP, METAL FILM, 1/20W 100K OHM J
RS53	24011223	CHIP, METAL FILM, 1/20W 22K OHM J
RS54	24011223	CHIP, METAL FILM, 1/20W 22K OHM J
RS55	24011103	CHIP, METAL FILM, 1/20W 10K OHM J
RS56	24011104	CHIP, METAL FILM, 1/20W 100K OHM J
RV07	24011103	CHIP, METAL FILM, 1/20W 10K OHM J
RV08	24011103	CHIP, METAL FILM, 1/20W 10K OHM J
RV09	24011101	CHIP, METAL FILM, 1/20W 100 OHM J
RV10	24011101	CHIP, METAL FILM, 1/20W 100 OHM J
RV23	24552101	OXIDE METAL FILM, 1/2W 100 OHM J
RV25	24011101	CHIP, METAL FILM, 1/20W 100 OHM J
RV26	24011471	CHIP, METAL FILM, 1/20W 470 OHM J
RV27	24872750	CHIP, METAL FILM, 1/16W 75 OHM J
RV30	24872750	CHIP, METAL FILM, 1/16W 75 OHM J
RV32	24872750	CHIP, METAL FILM, 1/16W 75 OHM J
RV33	24011562	CHIP, METAL FILM, 1/20W 5.6K OHM J
RV34	24011562	CHIP, METAL FILM, 1/20W 5.6K OHM J
RV43	24011222	CHIP, METAL FILM, 1/20W 2.2K OHM J
RV61	24552101	OXIDE METAL FILM, 1/2W 100 OHM J
RV62	24011101	CHIP, METAL FILM, 1/20W 100 OHM J
RV63	24011471	CHIP, METAL FILM, 1/20W 470 OHM J
RV66	24872750	CHIP, METAL FILM, 1/16W 75 OHM J
RV80	24366681	CARBON FILM, 1/6W 680 OHM J
RV81	24872750	CHIP, METAL FILM, 1/16W 75 OHM J
RV83	24366681	CARBON FILM, 1/6W 680 OHM J
RV84	24366223	CARBON FILM, 1/6W 22K OHM J
RV85	24872750	CHIP, METAL FILM, 1/16W 75 OHM J
RV86	24872750	CHIP, METAL FILM, 1/16W 75 OHM J
RV87	24872750	CHIP, METAL FILM, 1/16W 75 OHM J
RV88	24872151	CHIP, 1/16W 150 OHM J @U902
	24366223	CARBON FILM, 1/6W 22K OHM J @U904C
RV89	24872151	CHIP, 1/16W 150 OHM J
RV99	24366750	CARBON FILM, 1/6W 75 OHM J
COILS & TRANSFORMERS		
L101	23238562	COIL, PEAKING, TRF4109AJ
L102	23238561	COIL, PEAKING-0.82MMHK COLTRF4R82AJ
L103	23238554	COIL, PEAKING, TRF4R22AJ
L104	23248312	COIL, CHOKE 9.3X8.5H 330MMH TLN3040GH
L106	23289846	COIL, PEAKING, TRF4101AT
L111	23238715	COIL, PEAKING, TRF4829AJ
L112	23289100	COIL, PEAKING, TRF4100AF
L113	23289100	COIL, PEAKING, TRF4100AF
L300	23103145	FERRITE CHOKE, TEM2011AA
L410	23103145	FERRITE CHOKE, TEM2011AA
L441	#1 23233062	COIL, HILZ.LINEARITY TLN2225AT
	#2 23233036	COIL, HOLIZ LINEARITY, TLN2083AT
L442	23248122	COIL, CHOKE, TLN3384D
L461	23248238	COIL, CHOKE, TLN3335AF
L501	23289844	COIL, PEAKING, TRF4470AT
L502	23289844	COIL, PEAKING, TRF4470AT
L801	23217634	TRANSFORMER, CHOKE 65M0.9A TPW2055AS
L811	23103145	FERRITE CHOKE, TEM2011AA
L883	23221747	COIL, CHOKE, TRF9253D
L885	23248288	COIL, CHOKE, TLN3299GH
L893	23280016	COIL, PEAKING, TRF4100AZ

Location No.	Parts No.	Descriptiopn
L894	23289840	COIL, PEAKING, TRF4100AT
△ L901	#1 23200546	COIL, DG, TSB-2397AL
	#2 23200554	COIL, DG 0.50CU 60T-2LOOP TSB-2414AL
L908	23289840	COIL, PEAKING, TRF4100AT
L911	23289846	COIL, PEAKING, TRF4101AT
L4471	23289840	COIL, PEAKING, TRF4100AT
LA02	23103828	INDUCTOR, BEAD, TEM2121M
LA04	23103828	INDUCTOR, BEAD, TEM2121M
LA05	23103828	INDUCTOR, BEAD, TEM2121M
LA39	23103828	INDUCTOR, BEAD, TEM2121M
LC01	23103828	INDUCTOR, BEAD, TEM2121M
LC02	23103828	INDUCTOR, BEAD, TEM2121M
LC03	23103828	INDUCTOR, BEAD, TEM2121M
LC04	23103828	INDUCTOR, BEAD, TEM2121M
LC05	23238562	COIL, PEAKING, TRF4109AJ
LC06	23238562	COIL, PEAKING, TRF4109AJ
LC11	23248297	COIL, CHOKE, TLN3481GH
LC12	23248297	COIL, CHOKE, TLN3481GH
LC13	23248297	COIL, CHOKE, TLN3481GH
LC15	23103828	INDUCTOR, BEAD, TEM2121M
LC16	23103828	INDUCTOR, BEAD, TEM2121M
LC17	24000445	CHIP JUMPER, 1608TYPE
LC20	23103146	EMI FILTER, TEM2030AA
LC21	23103159	FILTER, EMI, TEM2028AA, 7.5X6.4X8 60MMH 0.5A
LV06	23289840	COIL, PEAKING, TRF4100AT
LV07	23289840	COIL, PEAKING, TRF4100AT
LV09	23289840	COIL, PEAKING, TRF4100AT
LV10	23103159	FILTER, EMI, TEM2028AA, 7.5X6.4X8 60MMH 0.5A
△ T400	23224386	TRANSFORMER, FOCUS, TLN2220AH
△ T401	23224373	TRANSFORMER, HORIZ DRIVE, TLN1100AM
△ T461	23236808	TRANSFORMER, FLY-BACK TFB4206AS
△ T801	23211780	COIL, LINE FILTER, TRF3228AR
△ T862	23217641	TRANSFORMER, CONVERTER TPW3537AD
SEMICONDUCTORS		
Q101	23114815	TRANSISTOR, 2SC388ATM(FA)
Q102	23114815	TRANSISTOR, 2SC388ATM(FA)
Q106	23314993	TRANSISTOR, 2SC4081 Q
Q107	23314994	TRANSISTOR, 2SA1576A106
Q200	23114756	TRANSISTOR, 2SC2482
Q274	23314993	TRANSISTOR, 2SC4081 Q
Q301	23009352	IC, AN5522
Q360	23314204	TRANSISTOR, 2SC2412K,Q
Q361	23314204	TRANSISTOR, 2SC2412K,Q
Q362	23314204	TRANSISTOR, 2SC2412K,Q
Q372	23114462	TRANSISTOR, RN1202
Q376	23314204	TRANSISTOR, 2SC2412K,Q
Q377	23114502	TRANSISTOR, RN1401
Q402	23114755	TRANSISTOR, 2SC2482FA-1
Q404	23314970	TRANSISTOR, 2SD2539(FA)
Q420	23205160	TRANSISTOR, NPN VCBO=100V KTD2092
Q421	23314965	TRANSISTOR, KTC3198 Y
Q430	23205160	TRANSISTOR, NPN VCBO=100V KTD2092
Q432	23314794	TRANSISTOR, 2PC1815Y
Q451	23314204	TRANSISTOR, 2SC2412K,Q
Q460	23205160	TRANSISTOR, NPN VCBO=100V KTD2092
Q461	23205081	TRANSISTOR, 2SA1980-Y
Q462	23205081	TRANSISTOR, 2SA1980-Y
Q463	23205081	TRANSISTOR, 2SA1980-Y
Q464	23205085	TRANSISTOR, 2SC5343-Y
Q465	23114463	TRANSISTOR, RN1201
Q470	23114541	TRANSISTOR, 2SA1320
Q471	23314794	TRANSISTOR, 2PC1815Y
Q472	23314794	TRANSISTOR, 2PC1815Y
Q473	23314791	TRANSISTOR, 2PA1015Y
Q501	23009563	IC, TB1261ANG
Q504	23314994	TRANSISTOR, 2SA1576A106
Q505	23314994	TRANSISTOR, 2SA1576A106
Q610	23318814	IC, TA8211AH
Q611	70114396	TRANSISTOR, 2SC3326B
Q612	70114396	TRANSISTOR, 2SC3326B
Q616	23205112	TRANSISTOR, 2SA1980UF-Y
Q801	23135041	IC, HYBRID STR-W6765
Q802	23205160	TRANSISTOR, NPN VCBO=100V KTD2092
Q805	23314965	TRANSISTOR, KTC3198 Y
△ Q826	23009270	IC, PHOTO COUPLER, PS2581L1(D)

Location No.	Parts No.	Description
Q827	23000352	IC, SE125N, LF4
Q840	23009188	IC, KIA7805API
Q841	23314965	TRANSISTOR, KTC3198 Y
Q842	23314965	TRANSISTOR, KTC3198 Y
Q861	23009188	IC, KIA7805API
Q901	23314052	TRANSISTOR, 2SC3619
Q902	23314965	TRANSISTOR, KTC3198 Y
Q903	23314052	TRANSISTOR, 2SC3619
Q904	23314965	TRANSISTOR, KTC3198 Y
Q905	23314052	TRANSISTOR, 2SC3619
Q906	23314965	TRANSISTOR, KTC3198 Y
Q907	23314962	TRANSISTOR, KTA1266 Y
Q908	23114429	TRANSISTOR, 2SC2120-Y(TE)
Q4490	23118952	IC, PHOTO COUPLER, TLP521-1 (FA)
Q4491	23314917	TRANSISTOR, 2SK2003-01MR
Q4493	23205085	TRANSISTOR, 2SC5343-Y
QA01	23009879	IC, SAA5563PS/M3/1368
QA02	23009647	IC, AT24C16A-10PI
QA03	23009616	IC, REGULATOR +3.3V 1% SOT-89 NJM2800U3342(TE1)
QA06	23205005	TRANSISTOR, KTA2014Y
QA07	23205005	TRANSISTOR, KTA2014Y
QA08	23205005	TRANSISTOR, KTA2014Y
QA09	23114499	TRANSISTOR, RN1404
QA10	70114402	TRANSISTOR, 2SC3437-Y
QA12	23205005	TRANSISTOR, KTA2014Y
QA13	23205005	TRANSISTOR, KTA2014Y
QB01	23205005	TRANSISTOR, KTA2014Y @U902
	23314965	TRANSISTOR, KTC3198Y @U904A
QB02	23205006	TRANSISTOR, KTC4075Y
QB30	23314965	TRANSISTOR, KTC3198 Y
QS05	70114396	TRANSISTOR, 2SC3326B
QS06	70114396	TRANSISTOR, 2SC3326B
QS09	23114493	TRANSISTOR, RN2404
QV01	23000369	IC, MM1495XD
QV03	23314993	TRANSISTOR, 2SC4081 Q
QV09	23314965	TRANSISTOR, KTC3198 Y
QV14	23314965	TRANSISTOR, KTC3198 Y
D102	23316755	DIODE, ZENER, MTZJ33C
D201	23118041	DIODE, MA111
D240	23118859	DIODE, 1SS133
D300	23316715	DIODE, ZENER, MTZJ11A
D301	23357366	DIODE, FR105-B5
D302	23357366	DIODE, FR105-B5
D303	23316794	DIODE, SC570A
D304	23357366	DIODE, FR105-B5
D320	23118859	DIODE, 1SS133
D321	23316687	DIODE, ZENER, MTZJ9.1B
D372	23118859	DIODE, 1SS133
D373	23118519	DIODE, ZENER, RD8.2ES
D374	23118859	DIODE, 1SS133
D406	23357366	DIODE, FR105-B5
D421	23357275	DIODE, ZENER, DZ7.5 BS A
D431	23316690	DIODE, ZENER, MTZJ10B
D436	23118859	DIODE, 1SS133
D441	23316690	DIODE, ZENER, MTZJ10B
D444	23316254	DIODE, ERC06-15
D461	23118338	DIODE, RU4AM LF-K2
D462	23118859	DIODE, 1SS133
D463	23118859	DIODE, 1SS133
D467	23357366	DIODE, FR105-B5
D470	23316720	DIODE, ZENER, MTZJ12C
D490	23118859	DIODE, 1SS133
D511	23316571	DIODE, ZENER, MA8056-M
D512	23316571	DIODE, ZENER, MA8056-M
D513	23316571	DIODE, ZENER, MA8056-M
D601	23357219	DIODE, 1SS400
D602	23357219	DIODE, 1SS400
D603	23357219	DIODE, 1SS400
D604	23357219	DIODE, 1SS400
D605	23357219	DIODE, 1SS400
D608	23357219	DIODE, 1SS400
D609	23357219	DIODE, 1SS400
D610	23357219	DIODE, 1SS400
D611	23357219	DIODE, 1SS400
D801	23357041	DIODE, LN6SB60-F05
D804	23357297	DIODE, ZENER, DZ15 BS B

Location No.	Parts No.	Description
D805	23357012	DIODE, 1SS244
D806	23357366	DIODE, FR105-B5
D807	23357325	DIODE, ZV=30.32-31.88 DZ33 BS B
D809	23357273	DIODE, ZENER, DZ6.8 BS B
D810	23357309	DIODE, ZENER, DZ22 BS B
D815	23357317	DIODE, ZENER, DZ27 BS B
D817	23115599	DIODE, 1N4148
D818	23357309	DIODE, ZENER, DZ22 BS B
D842	23357296	DIODE, ZV=13.48-14.09 DZ15 BS A
D844	23357279	DIODE, ZENER, DZ8.2 BS B
D848	23357270	DIODE, ZENER, DZ6.2 BS B
D855	23115599	DIODE, 1N4148
D883	23118338	DIODE, RU4AM LF-K2
D885	23118094	DIODE, EU2A
D892	23316714	DIODE, RL2Z
D896	23357366	DIODE, FR105-B5
D901	23118859	DIODE, 1SS133
D903	23118859	DIODE, 1SS133
D904	23118859	DIODE, 1SS133
D905	23118859	DIODE, 1SS133
D906	23118859	DIODE, 1SS133
D907	23118859	DIODE, 1SS133
D908	23118859	DIODE, 1SS133
D909	23118859	DIODE, 1SS133
D910	23118859	DIODE, 1SS133
D911	23357366	DIODE, FR105-B5
DA06	23357037	DIODE, ZENER, UDZS5.6B
DB01	23358564	DIODE, LED, SLR-56VC3FPQ
DR06	23357219	DIODE, 1SS400
DR08	23357219	DIODE, 1SS400
DV10	23357037	DIODE, ZENER, UDZS5.6B
MISCELLANEOUS		
B214	23974994	BAND, KESSOKU
B232	23974994	BAND, KESSOKU
BB21A	23713013	CONNECTOR, SOCKET, B-B 16P 1.5
BB21B	23713014	CONNECTOR, BRIDGE PLUG 16P 1.5
BB22A	23713013	CONNECTOR, SOCKET, B-B 16P 1.5
BB22B	23713014	CONNECTOR, BRIDGE PLUG 16P 1.5
E504 #1	23198655	EARTH WIRE, CRT EARTH 28" C995229E
△ F470	23144502	FUSE, CARTRIDGE 5.2X20, 250V 1.0A
F470A	23165102	FUSE HOLDER, CLIP, PC-BOARD D=5.2
△ F801	23144508	FUSE, CARTRIDGE 5.2X20, 250V 4.0A
F801A	23165102	FUSE HOLDER, CLIP, PC-BOARD D=5.2
△ F802	23144506	FUSE, CARTRIDGE 5.2X20, 50V 2.5A
F802A	23165102	FUSE HOLDER, CLIP, PC-BOARD D=5.2
G101	24000445	CHIP JUMPER, 1608TYPE
G103	23103828	INDUCTOR, BEAD, TEM2121M
G104	23103828	INDUCTOR, BEAD, TEM2121M
G105	24000445	CHIP JUMPER, 1608TYPE
G299	24366103	CARBON FILM, 1/6W 10K OHM J
G429	24552560	OXIDE METAL FILM, 1/2W 56 OHM J
G828	23103145	FERRITE CHOKE, TEM2011AA
G886	23103145	FERRITE CHOKE, TEM2011AA
G892	23103145	FERRITE CHOKE, TEM2011AA
G896	23103145	FERRITE CHOKE, TEM2011AA
GA26	23103828	INDUCTOR, BEAD, TEM2121M
GJ33	24000445	CHIP JUMPER, 1608TYPE
GJ101	24000445	CHIP JUMPER, 1608TYPE
GJ440	24000824	CHIP JUMPER, 2125TYPE
GR102	24000445	CHIP JUMPER, 1608TYPE
GR601	24000445	CHIP JUMPER, 1608TYPE
GR602	24000445	CHIP JUMPER, 1608TYPE
GR603	24000445	CHIP JUMPER, 1608TYPE
GR604	24000445	CHIP JUMPER, 1608TYPE
GR630	24000445	CHIP JUMPER, 1608TYPE
GRC01	24000445	CHIP JUMPER, 1608TYPE
GRC02	24000445	CHIP JUMPER, 1608TYPE
GRC15	24011331	CHIP, METAL FILM, 1/20W 330 OHM J
GRC16	24000445	CHIP JUMPER, 1608TYPE
GRC17	24000445	CHIP JUMPER, 1608TYPE
GRV04	24000445	CHIP JUMPER, 1608TYPE
GRV21	24000445	CHIP JUMPER, 1608TYPE
GRV22	24000445	CHIP JUMPER, 1608TYPE
GRV23	24000445	CHIP JUMPER, 1608TYPE
GRV24	24000445	CHIP JUMPER, 1608TYPE

Location No.	Parts No.	Description
H002	23148767	MODULE, NICAM/IGR MPSE22A
JP106 #1	24000524	METAL FILM 1/4W 4.3K F
P515A	23368581	CONNECTOR, PLUG 7P, 2.5MM G JST-EH B7B-EH-F1-TV4
P515B	23368581	CONNECTOR, PLUG 7P, 2.5MM G JST-EH B7B-EH-F1-TV4
P601A	23368578	CONNECTOR, PLUG 4P, 2.5MM G JST-EH, B4B-EH-F1-TV4
P605A	23368579	CONNECTOR, PLUG 5P, 2.5MM G JST-EH, B5B-EH-F1-TV4
P605B	23368579	CONNECTOR, PLUG 5P, 2.5MM G JST-EH, B5B-EH-F1-TV4
P661	23363607	JACK, HEAD PHONE, 3.5MM
△ P801	23372151	POWER CORD, AC250V3A L/FUSE13A GB13F1 FUSE13A
P801A	23368013	CONNECTOR, PLUG, 2P 11.88MM W VT-JST
P821A	23368013	CONNECTOR, PLUG, 2P 11.88MM W VT-JST
P821B	23368013	CONNECTOR, PLUG, 2P 11.88MM W VT-JST
P831A	23368013	CONNECTOR, PLUG, 2P 11.88MM W VT-JST
P831B	23368013	CONNECTOR, PLUG, 2P 11.88MM W VT-JST
P902A	23367068	CONNECTOR, PLUG 8P, 2.5MM G JST-EH B8B-EH-F1-TV4
P902B #2	23367068	CONNECTOR, PLUG 8P, 2.5MM G JST-EH B8B-EH-F1-TV4
P903A	23368580	CONNECTOR, PLUG 6P, 2.5MM G JST-EH B6B-EH-F1-TV4
P903B	23368580	CONNECTOR, PLUG 6P, 2.5MM G JST-EH B6B-EH-F1-TV4
PA01A	23368578	CONNECTOR, PLUG 4P, 2.5MM G JST-EH, B4B-EH-F1-TV4
PA01B	23368578	CONNECTOR, PLUG 4P, 2.5MM G JST-EH, B4B-EH-F1-TV4
PA02A	23368579	CONNECTOR, PLUG 5P, 2.5MM G JST-EH, B5B-EH-F1-TV4
PA02B	23368579	CONNECTOR, PLUG 5P, 2.5MM G JST-EH, B5B-EH-F1-TV4
PA102	23368579	CONNECTOR, PLUG 5P, 2.5MM G JST-EH, B5B-EH-F1-TV4
PH01	23365598	CONNECTOR, 21 PIN, 2100RFT
PH02	23365598	CONNECTOR, 21 PIN, 2100RFT
PV03	23365563	JACK, PIN 0S3P R_ANG ICE IJBH4-MYS
△ S801	23344416	SWITCH, POWER PUSH 2C1P ESB92D21B
SA01	23145430	SWITCH, PUSH, SKHHLMA010
SA02	23145430	SWITCH, PUSH, SKHHLMA010
SA03	23145430	SWITCH, PUSH, SKHHLMA010
SA04	23145430	SWITCH, PUSH, SKHHLMA010
SA05	23145430	SWITCH, PUSH, SKHHLMA010
△ SR83	23146570	RELAY, DC12V, 2M OMR, G5PA-2 DC12
△ T461A #1	23192964	ANODE CAP ASSY, TCC5606CT
△ T461B	23509441	CABLE ASSY, CABLE FOCUS
△ T461C	23509442	CABLE ASSY, CABLE FOCUS
△ T461D	23509372	CABLE ASSY, SCREEN
△ V901A	23903145	SOCKET, CRT, WFOCUS ISD35SE INCHANG ISD-35S-E
W660	23351222	SPEAKER, SPK1442AF ASSY SPK-1442AF ASSY
X501	23153979	CRYSTAL, 4.43MHZ PAL-APC
XA01	23153930	CRYSTAL
Z101	23303295	FILTER, FILTER, VIDEO 38.9M K3958M
Z102	23303237	FILTER, FILTER FOR I-NICAM(38.9 K9353M
Z104	23303189	CERAMIC TRAP, TCF1114
Z420	23144539	PROTECTOR, 491SERIES, 125V 2A
Z891	23144543	PROTECTOR, 491SERIES 125V 5A
Z898	23144542	PROTECTOR, 491SERIES, 125V 4A
PC BOARD ASSEMBLIES		
* U902 #1	23761101	PC BOARD ASSY, SIGNAL PWU PD1385A
#2	23761129	PC BOARD ASSY, SIGNAL PWU PD1385B
* U903A #1	23761102	PC BOARD ASSY, POWER&DEF PWU PD1386A-1
#2	23761130	PC BOARD ASSY, POWER&DEF PWU PD1386B-1
* U903B #1	23761103	PC BOARD ASSY, CRT-D PWU PD1386A-2
#2	23761131	PC BOARD ASSY, CRT-D PWU PD1386B-2
* U904A	23761104	PC BOARD ASSY, INDICATOR PWU PD1246B-1
* U904B	23761105	PC BOARD ASSY, BUTTON PWU PD1246B-2
* U904C	23761106	PC BOARD ASSY, AV PWU PD1246B-3
PICTURE TUBE		
△ V901 #1	23324061	PICTURE TUBE, W66QDE991X012
#2	23324062	PICTURE TUBE, W76QEN884X100
TUNER		
H001	23321474	TUNER, ALPS UK TEDB7-302A
ACCESSORIES		
K902	23306530	REMOCON HAND UNIT, CT-90179
KB01	23000852	IC, REMOTE PHOTO RECEIVER, PIC-37043TE2
△ Y101A	23566029	OWNER'S MANUAL, ENGLISH OWNERS MANUAL(ENG)
CABINET PARTS		
△ A201 #1	23532467	FRONT COVER
A201S #1	23532124	COVER, FRONT COVER SERVICE
#2	23532125	COVER, FRONT COVER SERVICE
A231 #1	23445632	BUTTON, BUTTON(POWER)

Location No.	Parts No.	Description
#2	23445725	KNOB, POWER BUTTON
A241	70368125	PUSH CATCH
A242 #1	23428087	DOOR, DOOR PROPER
#2	23428206	DOOR, DOOR PROPER
△ A401 #1	23530271	COVER, BACK COVER PROPER
#2	23530303	COVER, BACK COVER ASSEY
A430 #2	23530210	COVER, BACK COVER PROPER
A501 #1	23030187	SCREW CRT5X30BLUNT
A701 #1	23064898	CARTON, CARTON
#2	23064915	CARTON, CARTON
A702 #1	23946394	PACKING, BOTTOM PACKING
#2	23946346	PACKING, BOTTOM PACKING
A703 #1	23946395	PACKING, TOP PACKING
#2	23946347	PACKING, TOP PACKING

SIGNAL BOARD PD1385A (28Z33B)
SIGNAL BOARD PD1385B (32Z33B)
TOP (COMPONENT) SIDE

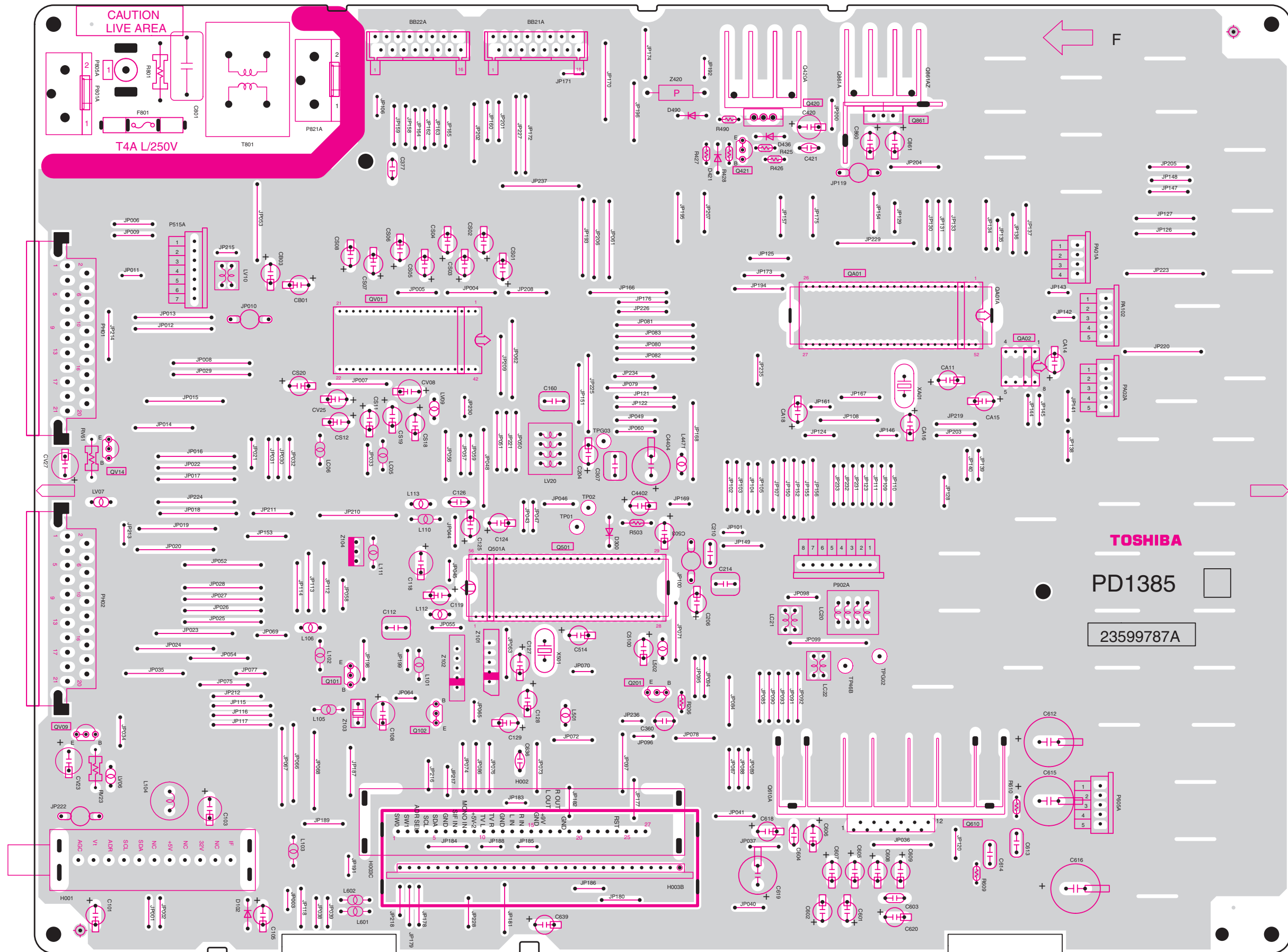

SIGNAL BOARD PD1385A (28Z33B)
SIGNAL BOARD PD1385B (32Z33B)
 BOTTOM (FOIL) SIDE

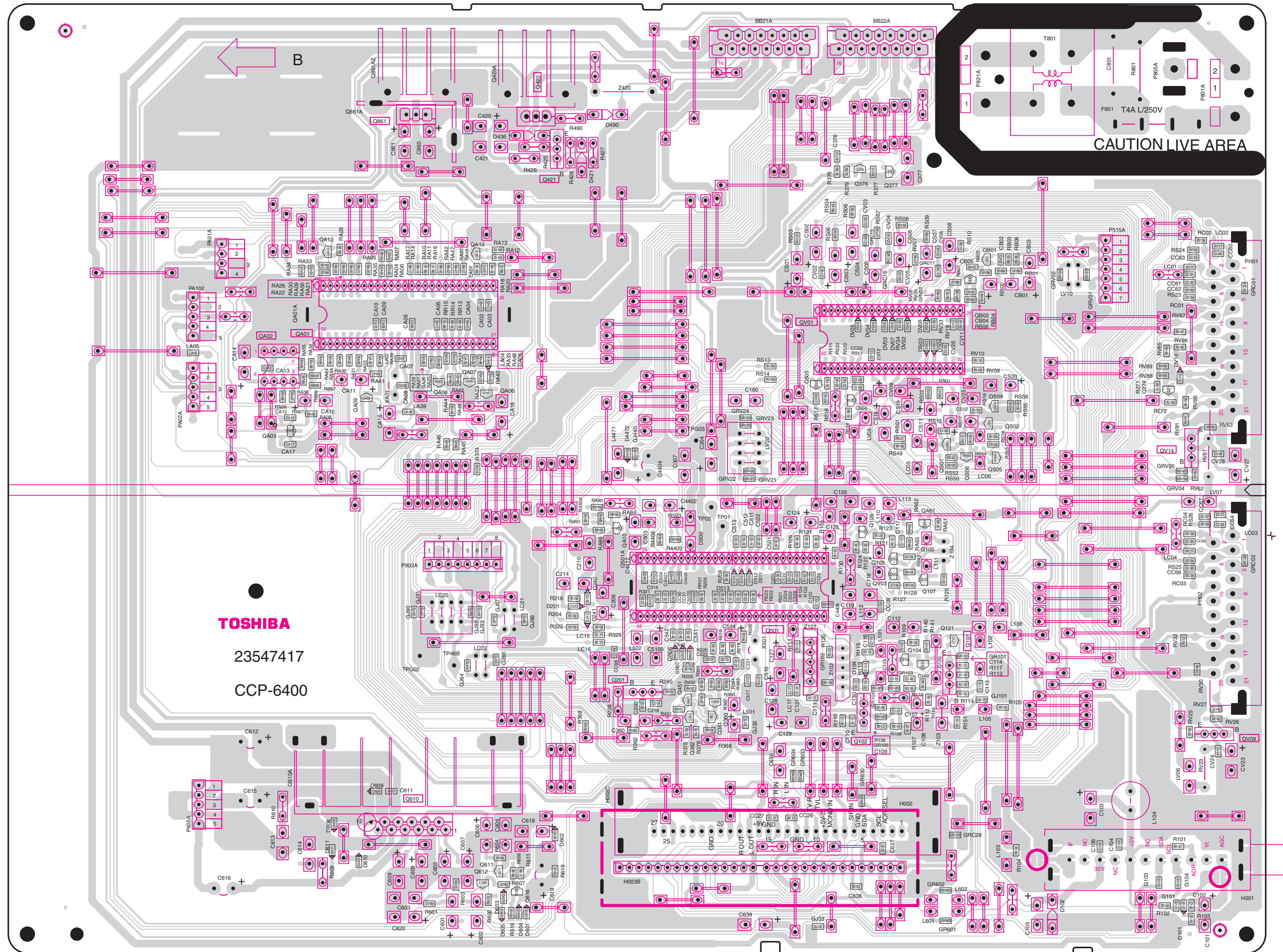

POWER & DEF/CRT-D BOARD PD1386A-1/A-2 (28Z33B)
POWER & DEF/CRT-D BOARD PD1386B-1/B-2 (32Z33B)
 TOP (COMPONENT) SIDE

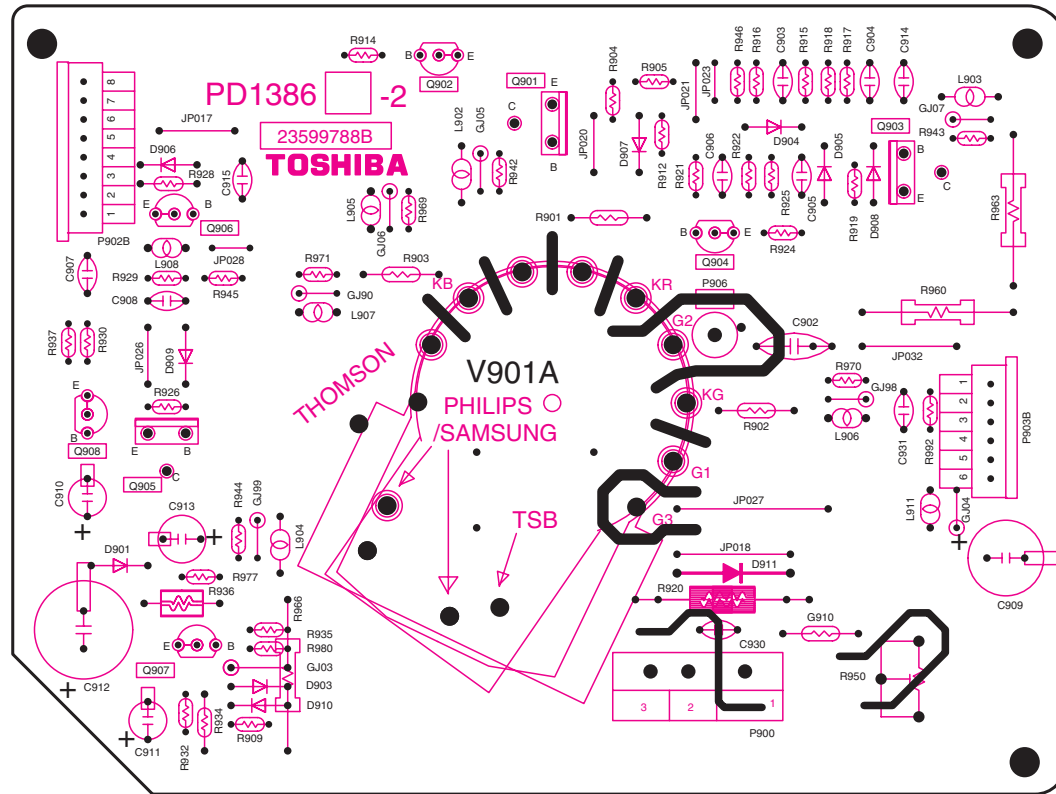

POWER & DEF/CRT-D BOARD PD1386A-1/A-2 (28Z33B)
POWER & DEF/CRT-D BOARD PD1386B-1/B-2 (32Z33B)
 BOTTOM (FOIL) SIDE

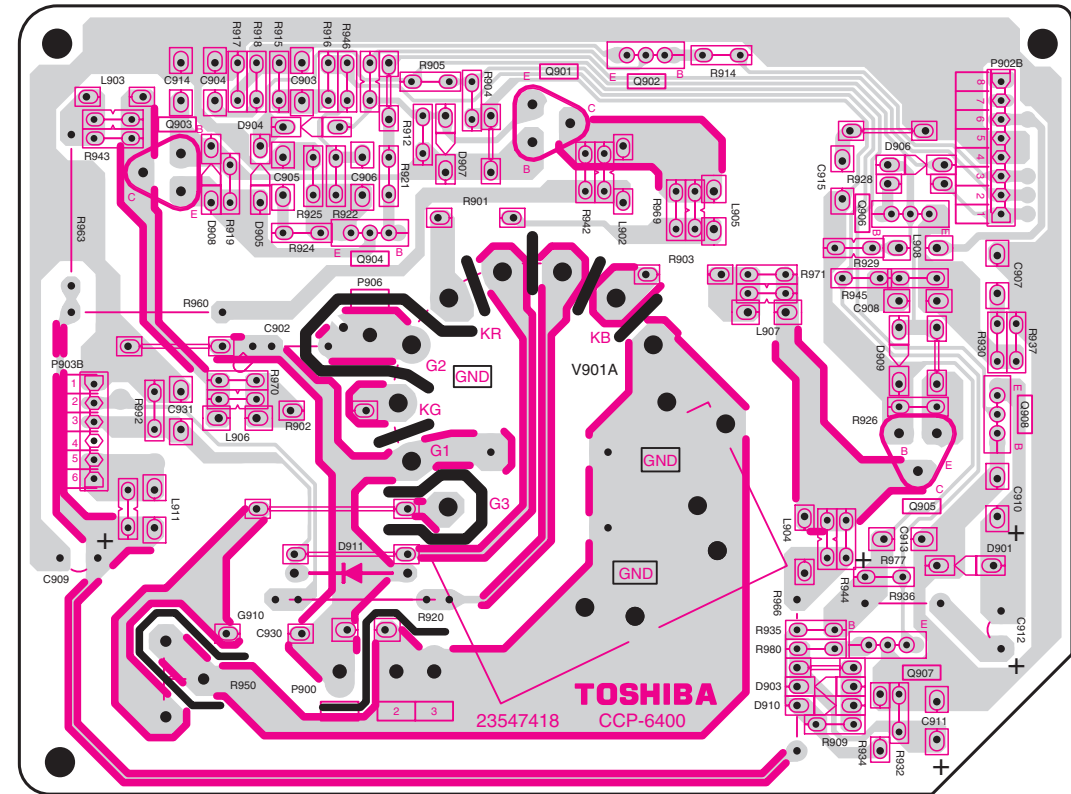

IND_BUTTON_AV BOARD PD1246B-1/B-2/B-3 (28Z33B)
 TOP (COMPONENT) SIDE

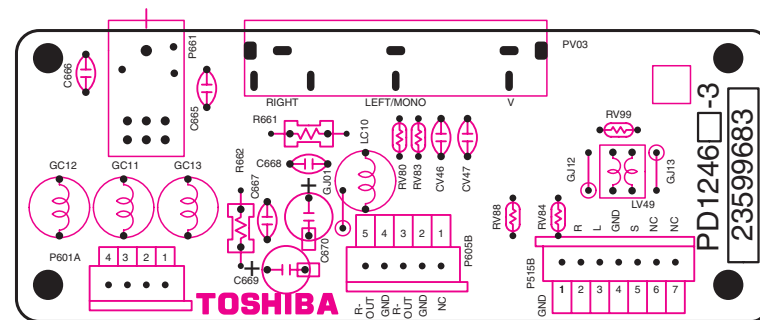

IND_BUTTON_AV BOARD PD1246B-1/B-2/B-3 (28Z33B)
 BOTTOM (FOIL) SIDE

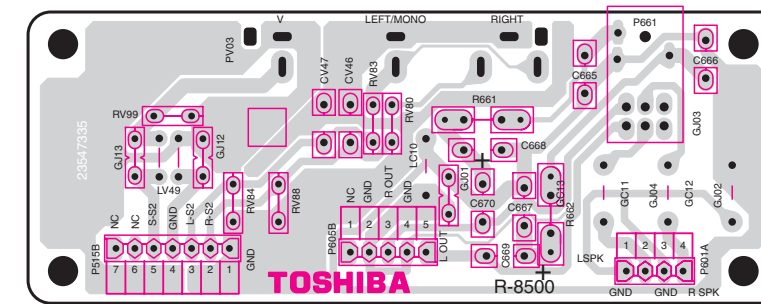

**THIS PAGE IS
INTENTIONALLY LEFT
BLANK.**

TERMINAL VIEW OF TRANSISTORS

- ① 2SD2253
(old)
2SC5243
2SC5570

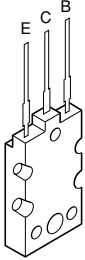

- ② 2SC3852
2SD1763A
2SC1569
2SC4544
2SA1788
2SA1306
2SA1186A

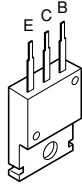

- ③ 2SC752GTM
2SC2482
2SC2655
2SC4721P



- ④ 2SC752
2SA562TM
2SA1015
2SC1815
2SC2878
2SC1740S
2SC2120
2SA9335

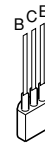

- ⑤ 2SA1788

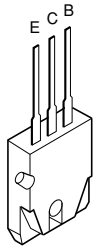

- ⑥ RN2203
RN2201
RN2004
RN1203
RN1204
RN2204
RN1205
RN1202
RN1201

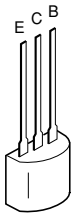

- ⑦ 2SD1554
2SD2253
2SD1556
2SC5143
2SD2553

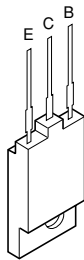

- ⑧ ON4409

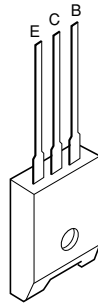

**THIS PAGE IS
INTENTIONALLY LEFT
BLANK.**

SCHEMATIC DIAGRAM

MODEL : 28Z33B/32Z33B

WARNING: BEFORE SERVICING THIS CHASSIS, READ THE "X-RAY RADIATION PRECAUTION", "SAFETY PRECAUTION" AND "PRODUCT SAFETY NOTICE" ON THE MANUAL FOR THIS MODEL.

CAUTION: The international hazard symbols " \triangle " in the schematic diagram and the parts list designate components which have special characteristics important for safety and should be replaced only with types identical to those in the original circuit or specified in the parts list. The mounting position of replacements is to be identical with originals. Before replacing any of these components, read carefully the PRODUCT SAFETY NOTICE on the MANUAL for this model. Do not degrade the safety of the receiver through improper servicing.

NOTE:

1. RESISTOR Resistance is shown in ohm [K = 1.000, M = 1.000.000]. All resistors are 1/6W and 5% tolerance carbon resistor, unless otherwise noted as the following marks.
 1/2R = Metal or Metal oxide of 1/2 watt 1/2S = Carbon composition of 1/2 watt
 1RF = Fuse resistor of 1 watt 10W = Cement of 10 watt
 K = $\pm 10\%$ G = $\pm 2\%$ F = $\pm 1\%$
2. CAPACITOR Unless otherwise noted in schematic, all capacitor values less than 1 are expressed in μF , and the values more than 1 in pF.
 All capacitors are ceramic 50V, unless otherwise noted as the following marks.
 $\text{---}^+ \text{||} \text{---}$ Electrolytic capacitor $\text{---}^\oplus \text{||} \text{---}$ Mylar capacitor
3. The parts indicated with " \triangle " have special characteristics, and should be replaced with identical parts only.
4. Voltages read with DIGITAL MULTI-METER from point indicated to chassis ground, using a color bar signal with all controls at normal, line voltage at 220 volts.
5. Waveforms are taken receiving color bar signal with enough sensitivity.
6. Voltage reading shown are nominal values and may vary $\pm 20\%$ except H.V.

■ SCHEMATIC DIAGRAM STRUCTURE:

SIGNAL Circuit	MICON	[SHEET- 1/4]	1/7
	VCD/IF/V OUT	[SHEET- 2/4]	2/7
	AV/AUDIO	[SHEET- 3/4]	3/7
	AC IN	[SHEET- 4/4]	4/7
POWER/DEF/CRT D Circuit	POWER/DEFLECTION	[SHEET- 1/2]	5/7
POWER/DEF/CRT D Circuit	CRT D	[SHEET- 2/2]	6/7
INDICATOR/BUTTON/AV Circuit		7/7

CIRCUIT BLOCK DIAGRAM

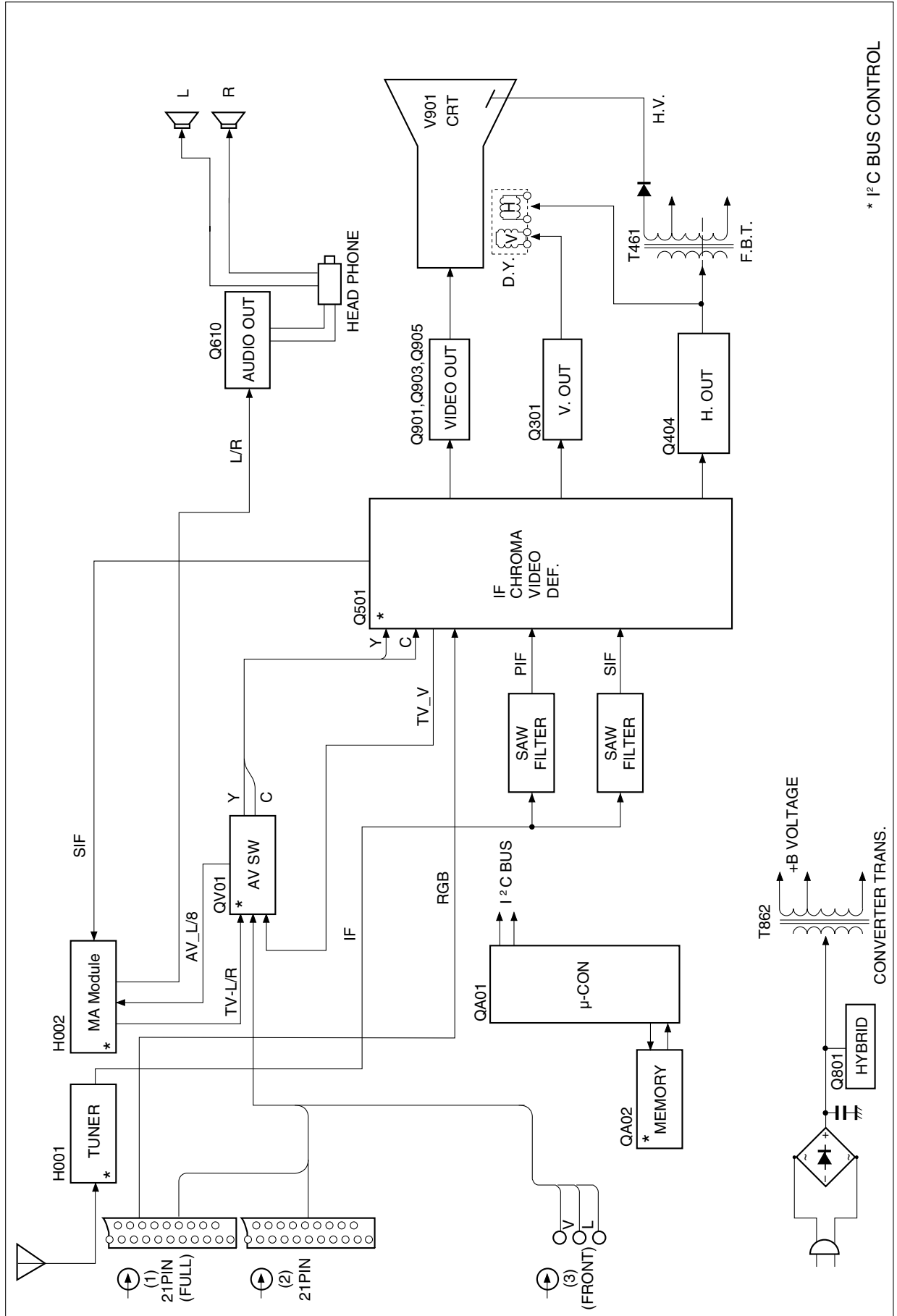

* I²C BUS CONTROL

SPECIFICATIONS

Broadcast systems/channels	PAL-I	UHF UK21-UK69		
Video Input	PAL, SECAM, NTSC 3.58/4.43			
External connections	EXT1	Input	21-pin Scart	RGB, A/V
	EXT2	Input	21-pin Scart	A/V, S-video
	EXT3	Input (front)	Phono jack	Video
			Phono jacks	Audio L + R
Programme Positions	100			
Stereo	Nicam			
	2 carrier system			
Visible Screen Size (approx.)	28ins	66cm		
	32ins	76cm		
Display	16:9			
Sound output (at 10% distortion)	Main	5W + 5W		
Power consumption as specified in EN60107-1 : 1997	28ins	95W		
	32ins	100W		
Standby	28ins	2.3W		
	32ins	2.3W		
Dimensions (approx.)	28ins	Height	55cm	
		Width	84cm	
		Depth	50cm	
	32ins	Height	60cm	
		Width	91cm	
		Depth	55cm	
Weight (approx.)	28ins	40kg		
	32ins	55kg		
Headphone socket	3.5mm stereo			

* Please refer to owner's manual in detail.

TOSHIBA CORPORATION
1-1, SHIBAURA 1-CHOME, MINATO-KU, TOKYO 105-8001, JAPAN