

## 16K x 1 Asynchronous CMOS Static RAM

March 1997

### Features

- Fast Access Time..... 70/85ns Max
- Low Standby Current.....50 $\mu$ A Max
- Low Operating Current ..... 50mA Max
- Data Retention at 2.0V.....20 $\mu$ A Max
- TTL Compatible Inputs and Outputs
- JEDEC Approved Pinout
- No Clocks or Strobes Required
- Temperature Range .....+55 $^{\circ}$ C to +125 $^{\circ}$ C
- Equal Cycle and Access Time
- Single 5V Supply
- Gated Inputs-No Pull-Up or Pull-Down Resistors Required

### Description

The HM-65262 is a CMOS 16384 x 1-bit Static Random Access Memory manufactured using the Intersil Advanced SAJI V process. The device utilizes asynchronous circuit design for fast cycle times and ease of use. The HM-65262 is available in both JEDEC standard 20 pin, 0.300 inch wide Cerdip and 20 pad CLCC packages, providing high board-level packing density. Gated inputs lower standby current, and also eliminate the need for pull-up or pull-down resistors.

The HM-65262, a full CMOS RAM, utilizes an array of six transistor (6T) memory cells for the most stable and lowest possible standby supply current over the full military temperature range. In addition to this, the high stability of the 6T RAM cell provides excellent protection against soft errors due to noise and alpha particles. This stability also improves the radiation tolerance of the RAM over that of four transistor (4T) devices.

### Ordering Information

PACKAGE	TEMP. RANGE	70ns/20 $\mu$ A (NOTE 1)	85ns/20 $\mu$ A (NOTE 1)	(NOTE 1) 85ns/400 $\mu$ A	PKG. NO.
CERDIP	-40 $^{\circ}$ C to +85 $^{\circ}$ C	HM1-65262B-9	HM1-65262-9	-	F20.3
JAN #	-55 $^{\circ}$ C to +125 $^{\circ}$ C	29109BRA	29103BRA	-	F20.3
SMD#	-55 $^{\circ}$ C to +125 $^{\circ}$ C	8413203RA	8413201RA	-	F20.3
CLCC (SMD#)	-55 $^{\circ}$ C to +125 $^{\circ}$ C	8413203YA	8413201YA	-	J20.C

NOTE:

1. Access Time/Data Retention Supply Current.

### Pinouts

HM-65262 (CERDIP)  
TOP VIEW

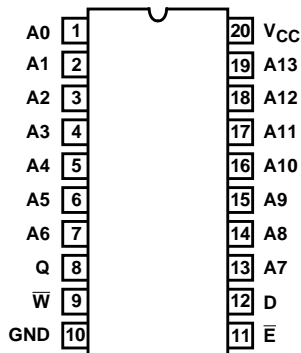

HM-65262 (CLCC)  
TOP VIEW

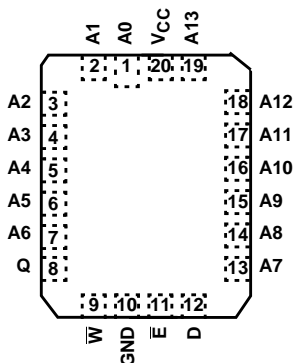

A0 - A13	Address Input
$\bar{E}$	Chip Enable/Power Down
Q	Data Out
D	Data In
V <sub>SS</sub> /GND	Ground
V <sub>CC</sub>	Power (+5)
$\bar{W}$	Write Enable

Functional Diagram

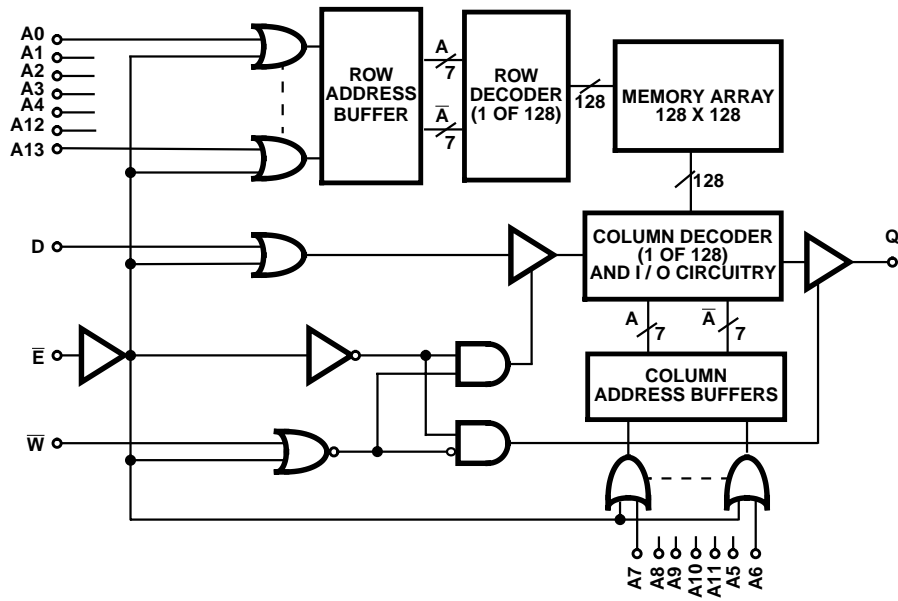

# HM-65262

## Absolute Maximum Ratings

Supply Voltage ..... +7.0V  
 Input or Output Voltage Applied for all grades ..... -0.3V to  $V_{CC} + 0.3V$   
 Typical Derating Factor ..... .5mA/MHz Increase in ICCOP  
 ESD Classification ..... Class 1

## Thermal Information

Thermal Resistance (Typical)  $\theta_{JA}$   $\theta_{JC}$   
 CERDIP Package ..... 66°C/W 13°C/W  
 CLCC Package ..... 75°C/W 18°C/W  
 Maximum Storage Temperature Range ..... -65°C to +150°C  
 Maximum Junction Temperature ..... +175°C  
 Maximum Lead Temperature (Soldering 10s) ..... +300°C

## Die Characteristics

Gate Count ..... 26256 Gates

*CAUTION: Stresses above those listed in "Absolute Maximum Ratings" may cause permanent damage to the device. This is a stress only rating and operation of the device at these or any other conditions above those indicated in the operational sections of this specification is not implied.*

## Operating Conditions

Operating Voltage Range ..... +4.5V to +5.5V      Operating Temperature Range  
 HM-65262B-9, HM-65262-9, HM-65262C-9 ..... -40°C to +85°C

## DC Electrical Specifications $V_{CC} = 5V \pm 10\%$ ; $T_A = -40^\circ C$ to $+85^\circ C$ (HM-65262B-9, HM-65262-9, HM-65262C-9)

SYMBOL	PARAMETER	LIMITS		UNITS	TEST CONDITIONS
		MIN	MAX		
ICCSB1	Standby Supply Current	-od	50	$\mu A$	HM-65262B-9, HM-65262-9, IO = 0mA, $\bar{E} = V_{CC} - 0.3V$ , $V_{CC} = 5.5V$
		-	900	$\mu A$	HM-65262C-9, IO = 0mA, $\bar{E} = V_{CC} - 0.3V$ , $V_{CC} = 5.5V$
ICCSB	Standby Supply Current	-	5	mA	$\bar{E} = 2.2V$ , IO = 0mA, $V_{CC} = 5.5V$
ICcen	Enabled Supply Current	-	50	mA	$\bar{E} = 0.8V$ , IO = 0mA, $V_{CC} = 5.5V$
ICcop	Operating Supply Current (Note 1)	-	50	mA	$\bar{E} = 0.8V$ , IO = 0mA, f = 1MHz, $V_{CC} = 5.5V$
ICCDR	Data Retention Supply Current	-	20	$\mu A$	HM-65262B-9, HM-65262-9, $V_{CC} = 2.0V$ , $\bar{E} = V_{CC}$
		-	400	$\mu A$	HM-65262C-9, $V_{CC} = 2.0V$ , $\bar{E} = V_{CC}$
ICCDR1	Data Retention Supply Current	-	30	$\mu A$	HM-65262B-9, HM-65262-9, $V_{CC} = 3.0V$ , $\bar{E} = V_{CC}$
		-	550	$\mu A$	HM-65262C-9, $V_{CC} = 3.0V$ , $\bar{E} = V_{CC}$
VCCDR	Data Retention Supply Voltage	2.0	-	V	
II	Input Leakage Current	-1.0	+1.0	$\mu A$	$V_I = V_{CC}$ or GND, $V_{CC} = 5.5V$
IOZ	Output Leakage Current	-1.0	+1.0	$\mu A$	$V_{IO} = V_{CC}$ or GND, $V_{CC} = 5.5V$
VIL	Input Low Voltage	-0.3	0.8	V	$V_{CC} = 4.5V$
VIH	Input High Voltage	2.2	$V_{CC} + 0.3$	V	$V_{CC} = 5.5V$
VOL	Output Low Voltage	-	0.4	V	IO = 8.0mA, $V_{CC} = 4.5V$
VOH1	Output High Voltage	2.4	-	V	IO = -4.0mA, $V_{CC} = 4.5V$
VOH2	Output High Voltage (Note 2)	$V_{CC} - 0.4$	-	V	IO = -100 $\mu A$ , $V_{CC} = 4.5V$

## Capacitance $T_A = +25^\circ C$

SYMBOL	PARAMETER	MAX	UNITS	TEST CONDITIONS
CI	Input Capacitance (Note 2)	10	pF	f = 1MHz, All measurements are referenced to device GND
CIO	Input/Output Capacitance (Note 2)	12	pF	

### NOTES:

1. Typical derating 5mA/MHz increase in ICCOP.
2. Tested at initial design and after major design changes.

## HM-65262

### AC Electrical Specifications $V_{CC} = 5V$ 10%, $T_A = -40^{\circ}C$ to $+85^{\circ}C$ (HM-65262B-9, HM-65262-9, HM-65262C-9)

SYMBOL	PARAMETER	LIMITS						UNITS	TEST CONDITIONS
		HM-65262B-9		HM-65262-9		HM-65262C-9			
		MIN	MAX	MIN	MAX	MIN	MAX		
<b>READ CYCLE</b>									
(1) TAVAX	Read/Cycle Time	70	-	85	-	85	-	ns	(Notes 1, 3)
(2) TAVQV	Address Access Time	-	70	-	85	-	85	ns	(Notes 1, 3)
(3) TELQV	Chip Enable Access Time	-	70	-	85	-	85	ns	(Notes 1, 3)
(4) TELQX	Chip Enable Output Enable Time	5	-	5	-	5	-	ns	(Notes 2, 3)
(5) TEHQX	Chip Disable Output Hold Time	5	-	5	-	5	-	ns	(Notes 2, 3)
(6) TAXQX	Address Invalid Output Hold Time	5	-	5	-	5	-	ns	(Notes 2, 3)
(7) TEHQZ	Chip Enable Output Disable Time	-	30	-	30	-	30	ns	(Notes 2, 3)
<b>WRITE CYCLE</b>									
(8) TAVAX	Write Cycle Time	70	-	85	-	85	-	ns	(Notes 1, 3)
(9) TELWH	Chip Selection to End of Write	55	-	65	-	65	-	ns	(Notes 1, 3)
(10) TWLWH	Write Enable Pulse Width	40	-	45	-	45	-	ns	(Notes 1, 3)
(11) TAVWL	Address Setup Time	0	-	0	-	0	-	ns	(Notes 1, 3)
(12) TWHAX	Address Hold Time	0	-	0	-	0	-	ns	(Notes 1, 3)
(13) TDVWH	Data Setup Time	30	-	35	-	35	-	ns	(Notes 1, 3)
(14) TWHDX	Data Hold Time	0	-	0	-	0	-	ns	(Notes 1, 3)
(15) TWLQZ	Write Enable Output Disable Time	-	30	-	30	-	30	ns	(Notes 2, 3)
(16) TWHQX	Write Disable Output Enable Time	0	-	0	-	0	-	ns	(Notes 2, 3)
(17) TAVWH	Address Valid to End of Write	55	-	65	-	65	-	ns	(Notes 1, 3)
(18) TAVEL	Address Setup Time	0	-	0	-	0	-	ns	(Notes 1, 3)
(19) TEHAX	Address Hold Time	0	-	0	-	0	-	ns	(Notes 1, 3)
(20) TAVEH	Address Valid to End of Write	55	-	65	-	65	-	ns	(Notes 1, 3)
(21) TELEH	Enable Pulse Width	55	-	65	-	65	-	ns	(Notes 1, 3)
(22) TWLEH	Write Enable Pulse Setup Time	40	-	45	-	45	-	ns	(Notes 1, 3)
(23) TDVEH	Chip Setup Time	30	-	35	-	35	0	ns	(Notes 1, 3)
(24) TEHDX	Data Hold Time	0	-	0	-	0	-	ns	(Notes 1, 3)

**NOTES:**

- Input pulse levels: 0 to 3.0V; Input rise and fall times: 5ns (max); Input and output timing reference level: 1.5V; Output load: 1 TTL gate equivalent and  $C_L = 50pF$  (min) - for  $C_L$  greater than 50pF, access time is derated by 0.15ns per pF.
- Tested at initial design and after major design changes.
- $V_{CC} = 4.5$  and  $5.5V$ .

Timing Waveforms

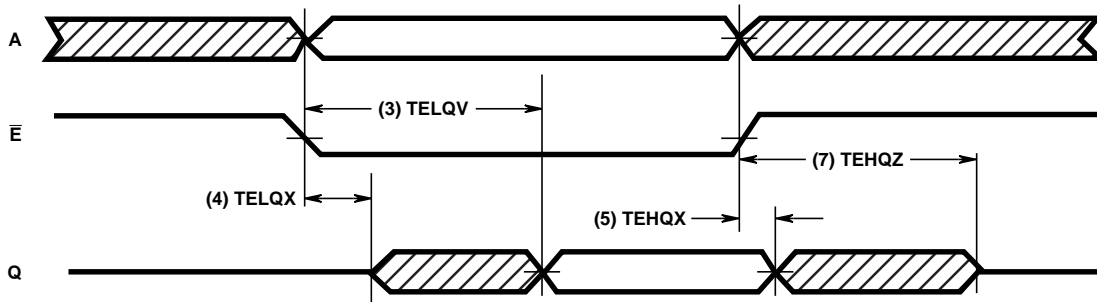

NOTE:

1.  $\bar{W}$  is high for entire cycle and D is ignored. Address is stable by the time  $\bar{E}$  goes low and remains valid until  $\bar{E}$  goes high.

FIGURE 1. READ CYCLE 1: CONTROLLED BY  $\bar{E}$

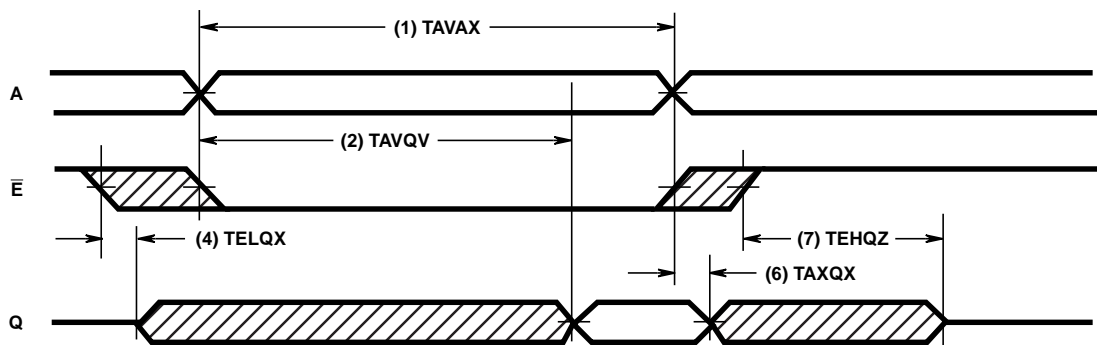

NOTE:

1.  $\bar{W}$  is high for the entire cycle and D is ignored.  $\bar{E}$  is stable prior to A becoming valid and after A becomes invalid.

FIGURE 2. READ CYCLE 2: CONTROLLED BY ADDRESS

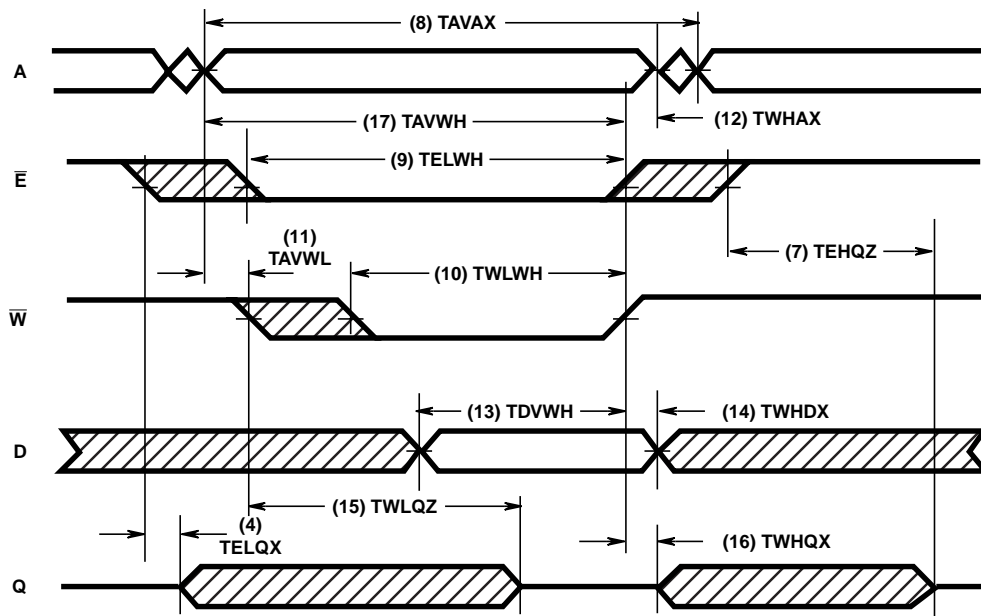

NOTE:

1. In this mode,  $\bar{E}$  rises after  $\bar{W}$ . The address must remain stable whenever both  $\bar{E}$  and  $\bar{W}$  are low.

FIGURE 3. WRITE CYCLE 1: CONTROLLED BY  $\bar{W}$  (LATE WRITE)

Timing Waveforms (Continued)

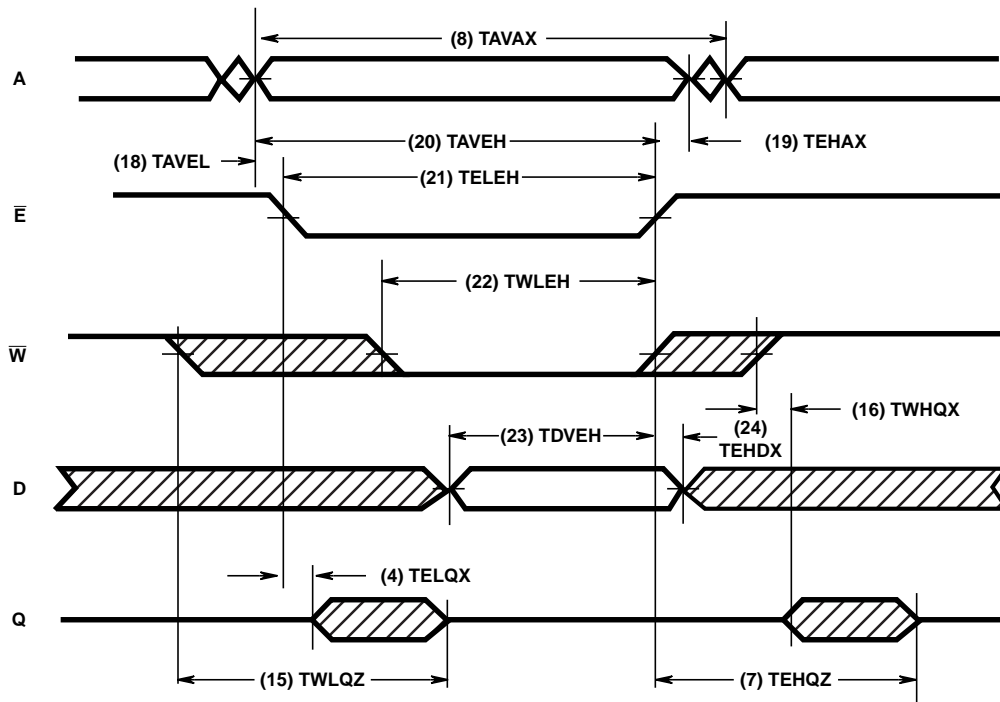

NOTE:

1. In this mode,  $\bar{W}$  rises after  $\bar{E}$ . If  $\bar{W}$  falls before  $\bar{E}$  by a time exceeding  $TWLQZ$  (Max)  $TELQX$  (Min), and rises after  $\bar{E}$  by a time exceeding  $TEHQZ$  (Max)  $TWHQX$  (Min), then  $Q$  will remain in the high impedance state throughout the cycle.

FIGURE 4. WRITE CYCLE 2: CONTROLLED BY  $\bar{E}$  (EARLY WRITE)

Low Voltage Data Retention

Intersil CMOS RAMs are designed with battery backup in mind. Data retention voltage and supply current are guaranteed over temperature. The following rules ensure data retention:

1. Chip Enable ( $\bar{E}$ ) must be held high during data retention; within  $V_{CC}$  to  $V_{CC} + 0.3V$ .
2. On RAMs which have selects or output enables (e.g.,  $S$ ,  $G$ ), one of the selects or output enables should be held in the deselected state to keep the RAM outputs high impedance, minimizing power dissipation.
3. Inputs which are to be held high (e.g.,  $\bar{E}$ ) must be kept between  $V_{CC} + 0.3V$  and 70% of  $V_{CC}$  during the power up and down transitions.
4. The RAM can begin operation  $> 55ns$  after  $V_{CC}$  reaches the minimum operating voltage (4.5V).

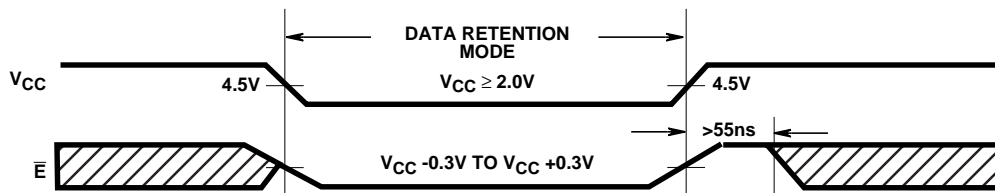

FIGURE 5. DATA RETENTION TIMING

**Typical Performance Curve**

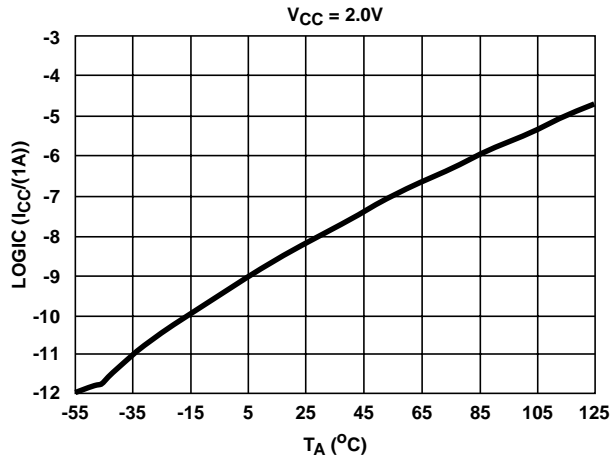

FIGURE 6. TYPICAL ICCDR vs T<sub>A</sub>

All Intersil semiconductor products are manufactured, assembled and tested under **ISO9000** quality systems certification.

*Intersil products are sold by description only. Intersil Corporation reserves the right to make changes in circuit design and/or specifications at any time without notice. Accordingly, the reader is cautioned to verify that data sheets are current before placing orders. Information furnished by Intersil is believed to be accurate and reliable. However, no responsibility is assumed by Intersil or its subsidiaries for its use; nor for any infringements of patents or other rights of third parties which may result from its use. No license is granted by implication or otherwise under any patent or patent rights of Intersil or its subsidiaries.*

For information regarding Intersil Corporation and its products, see web site <http://www.intersil.com>

**Sales Office Headquarters**

**NORTH AMERICA**

Intersil Corporation  
 P. O. Box 883, Mail Stop 53-204  
 Melbourne, FL 32902  
 TEL: (407) 724-7000  
 FAX: (407) 724-7240

**EUROPE**

Intersil SA  
 Mercure Center  
 100, Rue de la Fusee  
 1130 Brussels, Belgium  
 TEL: (32) 2.724.2111  
 FAX: (32) 2.724.22.05

**ASIA**

Intersil (Taiwan) Ltd.  
 Taiwan Limited  
 7F-6, No. 101 Fu Hsing North Road  
 Taipei, Taiwan  
 Republic of China  
 TEL: (886) 2 2716 9310  
 FAX: (886) 2 2715 3029