



The Infinite Bandwidth Company™

# MIC29150/29300/29500/29750 Series

## High-Current Low-Dropout Regulators

### General Description

The MIC29150/29300/29500/29750 are high current, high accuracy, low-dropout voltage regulators. Using Micrel's proprietary Super Beta PNP™ process with a PNP pass element, these regulators feature 300mV to 370mV (full load) dropout voltages and very low ground current. Designed for high current loads, these devices also find applications in lower current, extremely low dropout-critical systems, where their tiny dropout voltage and ground current values are important attributes.

The MIC29150/29300/29500/29750 are fully protected against overcurrent faults, reversed input polarity, reversed lead insertion, overtemperature operation, and positive and negative transient voltage spikes. Five pin fixed voltage versions feature logic level ON/OFF control and an error flag which signals whenever the output falls out of regulation. Flagged states include low input voltage (dropout), output current limit, overtemperature shutdown, and extremely high voltage spikes on the input.

On the MIC29xx1 and MIC29xx2, the ENABLE pin may be tied to  $V_{IN}$  if it is not required for ON/OFF control. The MIC29150/29300/29500 are available in 3- and 5-pin TO-220 and surface mount TO-263 packages. The MIC29750 7.5A regulators are available in 3- and 5-pin TO-247 packages.

### Features

- High Current Capability  
MIC29150/29151/29152/29153 ..... 1.5A  
MIC29300/29301/29302/29303 ..... 3A  
MIC29500/29501/29502/29503 ..... 5A  
MIC29750/29751/29752 ..... 7.5A
- Low-Dropout Voltage ..... 350mV at Full Load
- Low Ground Current
- Accurate 1% Guaranteed Tolerance
- Extremely Fast Transient Response
- Reverse-battery and "Load Dump" Protection
- Zero-Current Shutdown Mode (5-Pin versions)
- Error Flag Signals Output Out-of-Regulation (5-Pin versions)
- Also Characterized For Smaller Loads With Industry-Leading Performance Specifications
- Fixed Voltage and Adjustable Versions

### Applications

- Battery Powered Equipment
- High-Efficiency "Green" Computer Systems
- Automotive Electronics
- High-Efficiency Linear Power Supplies
- High-Efficiency Post-Regulator For Switching Supply

### Pin Configuration

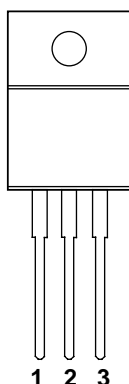

MIC29150/29300/  
29500BT and  
MIC29750BWT

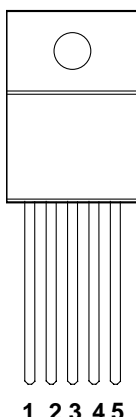

MIC29151/29152/29153BT  
MIC29301/29302/29303BT  
MIC29501/29502/29503BT  
MIC29751/29752BWT

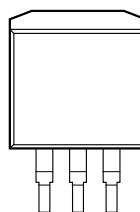

MIC29150/29300BU

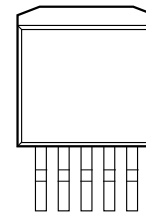

MIC29151/29152/29153BU  
MIC29301/29302/29303BU  
MIC29501/29502/29503BU

**Pinout** On all devices, the Tab is grounded.

**MIC29150/29300/29500/29750 Three Terminal Devices:**

Pin 1 = Input, 2 = Ground, 3 = Output

**MIC29151/29301/29501/29751 Five Terminal Fixed Voltage Devices:**

Pin 1 = Enable, 2 = Input, 3 = Ground, 4 = Output, 5 = Flag

**MIC29152/29302/29502/29752 Adjustable with ON/OFF Control**

Pin 1 = Enable, 2 = Input, 3 = Ground, 4 = Output, 5 = Adjust

**MIC29153/29303/29503 Adjustable with Flag**

Pin 1 = Flag, 2 = Input, 3 = Ground, 4 = Output, 5 = Adjust

## Ordering Information

| Part Number    | Temp. Range*  | Volts | Current | Package  |
|----------------|---------------|-------|---------|----------|
| MIC29150-3.3BT | -40 to +125°C | 3.3   | 1.5A    | TO-220   |
| MIC29150-4.2BT | -40 to +125°C | 4.2   | 1.5A    | TO-220   |
| MIC29150-5.0BT | -40 to +125°C | 5.0   | 1.5A    | TO-220   |
| MIC29150-12BT  | -40 to +125°C | 12    | 1.5A    | TO-220   |
| MIC29150-3.3BU | -40 to +125°C | 3.3   | 1.5A    | TO-263   |
| MIC29150-5.0BU | -40 to +125°C | 5.0   | 1.5A    | TO-263   |
| MIC29150-12BU  | -40 to +125°C | 12    | 1.5A    | TO-263   |
| MIC29151-3.3BT | -40 to +125°C | 3.3   | 1.5A    | TO-220-5 |
| MIC29151-5.0BT | -40 to +125°C | 5.0   | 1.5A    | TO-220-5 |
| MIC29151-12BT  | -40 to +125°C | 12    | 1.5A    | TO-220-5 |
| MIC29151-3.3BU | -40 to +125°C | 3.3   | 1.5A    | TO-263-5 |
| MIC29151-5.0BU | -40 to +125°C | 5.0   | 1.5A    | TO-263-5 |
| MIC29151-12BU  | -40 to +125°C | 12    | 1.5A    | TO-263-5 |
| MIC29152BT     | -40 to +125°C | Adj   | 1.5A    | TO-220-5 |
| MIC29152BU     | -40 to +125°C | Adj   | 1.5A    | TO-263-5 |
| MIC29153BT     | -40 to +125°C | Adj   | 1.5A    | TO-220-5 |
| MIC29153BU     | -40 to +125°C | Adj   | 1.5A    | TO-263-5 |
| MIC29300-3.3BT | -40 to +125°C | 3.3   | 3.0A    | TO-220   |
| MIC29300-5.0BT | -40 to +125°C | 5.0   | 3.0A    | TO-220   |
| MIC29300-12BT  | -40 to +125°C | 12    | 3.0A    | TO-220   |
| MIC29300-3.3BU | -40 to +125°C | 3.3   | 3.0A    | TO-263   |
| MIC29300-5.0BU | -40 to +125°C | 5.0   | 3.0A    | TO-263   |
| MIC29300-12BU  | -40 to +125°C | 12    | 3.0A    | TO-263   |
| MIC29301-3.3BT | -40 to +125°C | 3.3   | 3.0A    | TO-220-5 |
| MIC29301-5.0BT | -40 to +125°C | 5.0   | 3.0A    | TO-220-5 |
| MIC29301-12BT  | -40 to +125°C | 12    | 3.0A    | TO-220-5 |
| MIC29301-3.3BU | -40 to +125°C | 3.3   | 3.0A    | TO-263-5 |
| MIC29301-5.0BU | -40 to +125°C | 5.0   | 3.0A    | TO-263-5 |
| MIC29301-12BU  | -40 to +125°C | 12    | 3.0A    | TO-263-5 |
| MIC29302BT     | -40 to +125°C | Adj   | 3.0A    | TO-220-5 |
| MIC29302BU     | -40 to +125°C | Adj   | 3.0A    | TO-263-5 |
| MIC29303BT     | -40 to +125°C | Adj   | 3.0A    | TO-220-5 |
| MIC29303BU     | -40 to +125°C | Adj   | 3.0A    | TO-263-5 |

\* Junction Temperature

| Part Number     | Temp. Range*  | Volts | Current | Package  |
|-----------------|---------------|-------|---------|----------|
| MIC29500-3.3BT  | -40 to +125°C | 3.3   | 5.0A    | TO-220   |
| MIC29500-5.0BT  | -40 to +125°C | 5.0   | 5.0A    | TO-220   |
| MIC29501-3.3BT  | -40 to +125°C | 3.3   | 5.0A    | TO-220-5 |
| MIC29501-5.0BT  | -40 to +125°C | 5.0   | 5.0A    | TO-220-5 |
| MIC29501-3.3BU  | -40 to +125°C | 3.3   | 5.0A    | TO-263-5 |
| MIC29501-5.0BU  | -40 to +125°C | 5.0   | 5.0A    | TO-263-5 |
| MIC29502BT      | -40 to +125°C | Adj   | 5.0A    | TO-220-5 |
| MIC29502BU      | -40 to +125°C | Adj   | 5.0A    | TO-263-5 |
| MIC29503BT      | -40 to +125°C | Adj   | 5.0A    | TO-220-5 |
| MIC29503BU      | -40 to +125°C | Adj   | 5.0A    | TO-263-5 |
| MIC29750-3.3BWT | -40 to +125°C | 3.3   | 7.5A    | TO-247-3 |
| MIC29750-5.0BWT | -40 to +125°C | 5.0   | 7.5A    | TO-247-3 |
| MIC29751-3.3BWT | -40 to +125°C | 3.3   | 7.5A    | TO-247-5 |
| MIC29751-5.0BWT | -40 to +125°C | 5.0   | 7.5A    | TO-247-5 |
| MIC29752BWT     | -40 to +125°C | Adj   | 7.5A    | TO-247-5 |

MIC29xx0 versions are 3-terminal fixed voltage devices. MIC29xx1 are fixed voltage devices with ENABLE and ERROR flag. MIC29xx2 are adjustable regulators with ENABLE control. MIC29xx3 are adjustables with an ERROR flag.

**Absolute Maximum Ratings**

|   |                    |
|---|--------------------|
| Power Dissipation .....                       | Internally Limited |
| Lead Temperature (Soldering, 5 seconds) ..... | 260°C              |
| Storage Temperature Range .....               | -65°C to +150°C    |
| Input Supply Voltage (Note 1) .....           | -20V to +60V       |

**Operating Ratings**

|                                       |                 |
|---------------------------------------|-----------------|
| Operating Junction Temperature .....  | -40°C to +125°C |
| Maximum Operating Input Voltage ..... | 26V             |
| TO-220 $\theta_{JC}$ .....            | 2°C/W           |
| TO-263 $\theta_{JC}$ .....            | 2°C/W           |
| TO-247 $\theta_{JC}$ .....            | 1.5°C/W         |

**Electrical Characteristics**

All measurements at  $T_J = 25^\circ\text{C}$  unless otherwise noted. **Bold** values are guaranteed across the operating temperature range. Adjustable versions are programmed to 5.0V.

| Parameter   | Condition  | Min | Typ        | Max         | Units               |
|---|--|-----|------------|-------------|---------------------|
| Output Voltage  | $I_O = 10\text{mA}$  | -1  |            | 1           | %                   |
|   | $10\text{mA} \leq I_O \leq I_{FL}, (V_{OUT} + 1\text{V}) \leq V_{IN} \leq 26\text{V}$ (Note 2) | -2  |            | <b>2</b>    | %                   |
| Line Regulation   | $I_O = 10\text{mA}, (V_{OUT} + 1\text{V}) \leq V_{IN} \leq 26\text{V}$                         |     | 0.06       | 0.5         | %                   |
| Load Regulation   | $V_{IN} = V_{OUT} + 5\text{V}, 10\text{mA} \leq I_{OUT} \leq I_{FULL\ LOAD}$ (Note 2, 6)       |     | 0.2        | 1           | %                   |
| $\frac{\Delta V_O}{\Delta T}$   | Output Voltage (Note 6)<br>Temperature Coef.   |     | <b>20</b>  | <b>100</b>  | ppm/°C              |
| Dropout Voltage   | $\Delta V_{OUT} = -1\%$ , (Note 3)   |     |            |             |                     |
|   | MIC29150 $I_O = 100\text{mA}$  |     | 80         | <b>200</b>  | mV                  |
|   | $I_O = 750\text{mA}$   |     | 220        |             |                     |
|   | $I_O = 1.5\text{A}$  |     | 350        | <b>600</b>  |                     |
|   | MIC29300 $I_O = 100\text{mA}$  |     | 80         | <b>175</b>  |                     |
|   | $I_O = 1.5\text{A}$  |     | 250        |             |                     |
|   | $I_O = 3\text{A}$  |     | 370        | <b>600</b>  |                     |
|   | MIC29500 $I_O = 250\text{mA}$  |     | 125        | <b>250</b>  |                     |
|   | $I_O = 2.5\text{A}$  |     | 250        |             |                     |
|   | $I_O = 5\text{A}$  |     | 370        | <b>600</b>  |                     |
|   | MIC29750 $I_O = 250\text{mA}$  |     | 80         | <b>200</b>  |                     |
|   | $I_O = 4\text{A}$  |     | 270        |             |                     |
| $I_O = 7.5\text{A}$   |  | 425 | <b>600</b> |             |                     |
| Ground Current  | MIC29150 $I_O = 750\text{mA}, V_{IN} = V_{OUT} + 1\text{V}$                                    |     | 8          | <b>20</b>   | mA                  |
|   | $I_O = 1.5\text{A}$  |     | 22         |             |                     |
|   | MIC29300 $I_O = 1.5\text{A}, V_{IN} = V_{OUT} + 1\text{V}$                                     |     | 10         | <b>35</b>   | mA                  |
|   | $I_O = 3\text{A}$  |     | 37         |             |                     |
| www.DataSheet4U.com   | MIC29500 $I_O = 2.5\text{A}, V_{IN} = V_{OUT} + 1\text{V}$                                     |     | 15         | <b>50</b>   | mA                  |
|   | $I_O = 5\text{A}$  |     | 70         |             |                     |
| MIC29750 $I_O = 4\text{A}, V_{IN} = V_{OUT} + 1\text{V}$              |  | 35  | <b>75</b>  | mA          |                     |
| $I_O = 7.5\text{A}$   |  | 120 |            |             |                     |
| $I_{GNDDO}$ Ground Pin Current at Dropout                             | $V_{IN} = 0.5\text{V}$ less than specified $V_{OUT}, I_{OUT} = 10\text{mA}$                    |     |            |             |                     |
|   | MIC29150   |     | 0.9        |             | mA                  |
|   | MIC29300   |     | 1.7        |             | mA                  |
|   | MIC29500   |     | 2.1        |             | mA                  |
|   | MIC29750   |     | 3.1        |             | mA                  |
| Current Limit   | MIC29150 $V_{OUT} = 0\text{V}$ (Note 4)  |     | 2.1        | <b>3.5</b>  | A                   |
|   | MIC29300 $V_{OUT} = 0\text{V}$ (Note 4)  |     | 4.5        | <b>5.0</b>  | A                   |
|   | MIC29500 $V_{OUT} = 0\text{V}$ (Note 4)  |     | 7.5        | <b>10.0</b> | A                   |
|   | MIC29750 $V_{OUT} = 0\text{V}$ (Note 4)  |     | 9.5        | <b>15</b>   | A                   |
| $e_n$ , Output Noise Voltage (10Hz to 100kHz)<br>$I_L = 100\text{mA}$ | $C_L = 10\mu\text{F}$  |     | 400        |             | $\mu\text{V}$ (rms) |
|   | $C_L = 33\mu\text{F}$  |     | 260        |             |                     |
| Ground Current in Shutdown  | MIC29150/1/2/3 only $V_{EN} = 0.4\text{V}$   |     | 2          | 10          | $\mu\text{A}$       |
|   |  |     |            | <b>30</b>   | $\mu\text{A}$       |

**Electrical Characteristics (Continued)****Reference MIC29xx2/MIC29xx3**

| Parameter                                       | Conditions | Min                   | Typical | Max                   | Units      |
|---|------------|-----------------------|---------|-----------------------|------------|
| Reference Voltage                               |            | 1.228<br><b>1.215</b> | 1.240   | 1.252<br><b>1.265</b> | V<br>V max |
| Reference Voltage                               | (Note 8)   | <b>1.203</b>          |         | <b>1.277</b>          | V          |
| Adjust Pin Bias Current                         |            |                       | 40      | 80<br><b>120</b>      | nA         |
| Reference Voltage Temperature Coefficient       | (Note 7)   |                       | 20      |                       | ppm/°C     |
| Adjust Pin Bias Current Temperature Coefficient |            |                       | 0.1     |                       | nA/°C      |

**Flag Output (Error Comparator) MIC29xx1/29xx3**

|                         |   |                 |      |                     |         |
|-------------------------|---|-----------------|------|---------------------|---------|
| Output Leakage Current  | $V_{OH} = 26V$  |                 | 0.01 | 1.00<br><b>2.00</b> | $\mu A$ |
| Output Low Voltage      | Device set for 5V. $V_{IN} = 4.5V$<br>$I_{OL} = 250\mu A$ |                 | 220  | 300<br><b>400</b>   | mV      |
| Upper Threshold Voltage | Device set for 5V (Note 9)                                | 40<br><b>25</b> | 60   |                     | mV      |
| Lower Threshold Voltage | Device set for 5V (Note 9)                                |                 | 75   | 95<br><b>140</b>    | mV      |
| Hysteresis              | Device set for 5V (Note 9)                                |                 | 15   |                     | mV      |

**ENABLE Input MIC29xx1/MIC29xx2**

|  |                 |            |     |                   |         |
|--|-----------------|------------|-----|-------------------|---------|
| Input Logic Voltage Low (OFF)<br>High (ON) |                 | <b>2.4</b> |     | <b>0.8</b>        | V       |
| Enable Pin Input Current                   | $V_{EN} = 26V$  |            | 100 | 600<br><b>750</b> | $\mu A$ |
|  | $V_{EN} = 0.8V$ |            |     | 1<br><b>2</b>     | $\mu A$ |
| Regulator Output Current in Shutdown       | (Note 10)       |            | 10  | <b>500</b>        | $\mu A$ |

## Notes

- Note 1:** Maximum positive supply voltage of 60V must be of limited duration (<100msec) and duty cycle ( $\leq 1\%$ ). The maximum continuous supply voltage is 26V.
- Note 2:** Full Load current ( $I_{FL}$ ) is defined as 1.5A for the MIC29150, 3A for the MIC29300, 5A for the MIC29500, and 7.5A for the MIC29750 families.
- Note 3:** Dropout voltage is defined as the input-to-output differential when the output voltage drops to 99% of its nominal value with  $V_{OUT} + 1V$  applied to  $V_{IN}$ .
- Note 4:**  $V_{IN} = V_{OUT(nominal)} + 1V$ . For example, use  $V_{IN} = 4.3V$  for a 3.3V regulator or use 6V for a 5V regulator. Employ pulse-testing procedures to minimize temperature rise.
- Note 5:** Ground pin current is the regulator quiescent current. The total current drawn from the source is the sum of the load current plus the ground pin current.
- Note 6:** Output voltage temperature coefficient is defined as the worst case voltage change divided by the total temperature range.
- Note 7:** Thermal regulation is defined as the change in output voltage at a time T after a change in power dissipation is applied, excluding load or line regulation effects. Specifications are for a 200mA load pulse at  $V_{IN} = 20V$  (a 4W pulse) for T = 10ms.
- Note 8:**  $V_{REF} \leq V_{OUT} \leq (V_{IN} - 1V)$ ,  $2.3V \leq V_{IN} \leq 26V$ ,  $10mA < I_L \leq I_{FL}$ ,  $T_J \leq T_{JMAX}$ .
- Note 9:** Comparator thresholds are expressed in terms of a voltage differential at the Adjust terminal below the nominal reference voltage measured at 6V input. To express these thresholds in terms of output voltage change, multiply by the error amplifier gain =  $V_{OUT}/V_{REF} = (R1 + R2)/R2$ . For example, at a programmed output voltage of 5V, the Error output is guaranteed to go low when the output drops by  $95mV \times 5V/1.240V = 384mV$ . Thresholds remain constant as a percent of  $V_{OUT}$  as  $V_{OUT}$  is varied, with the dropout warning occurring at typically 5% below nominal, 7.7% guaranteed.
- Note 10:**  $V_{EN} \leq 0.8V$  and  $V_{IN} \leq 26V$ ,  $V_{OUT} = 0$ .
- Note 11:** When used in dual supply systems where the regulator load is returned to a negative supply, the output voltage must be diode clamped to ground.

## Block Diagram

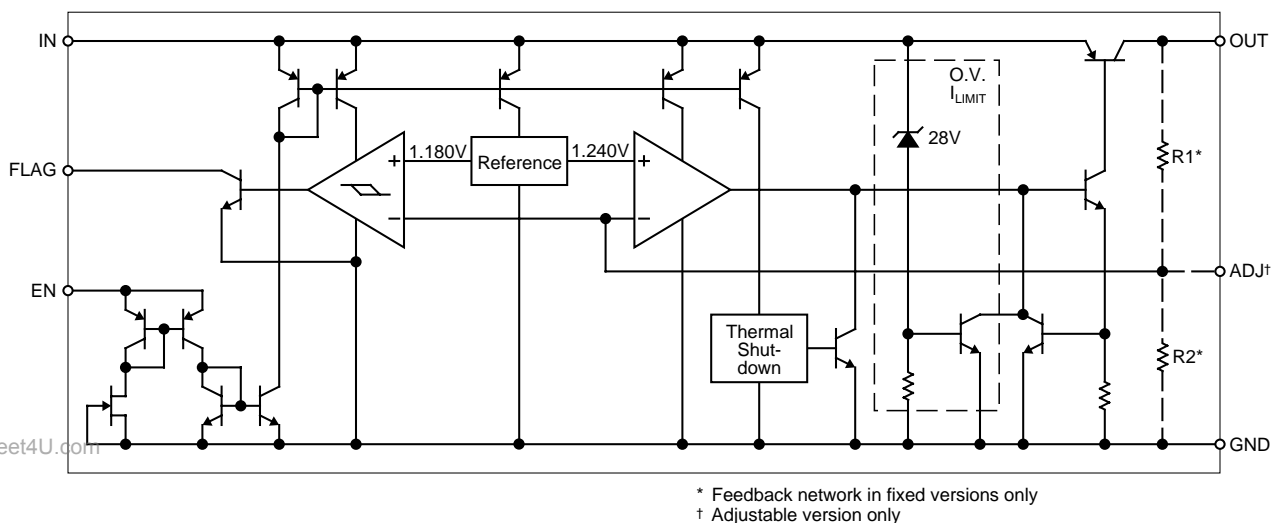

## Typical Applications

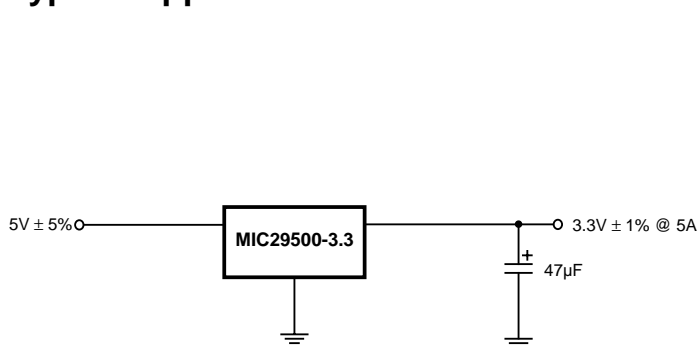

Figure 1. Fixed output voltage.

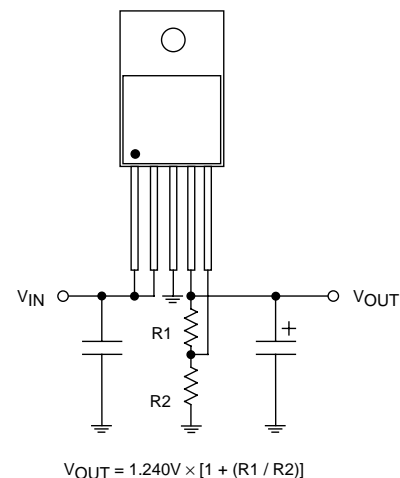
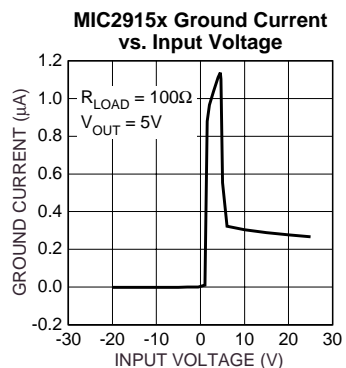
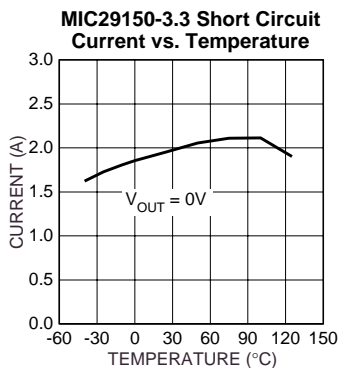
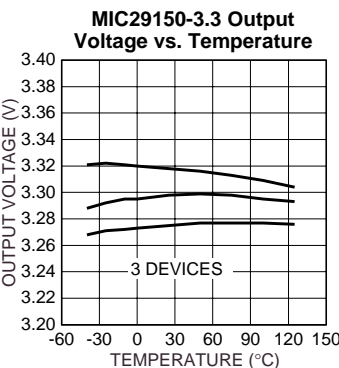
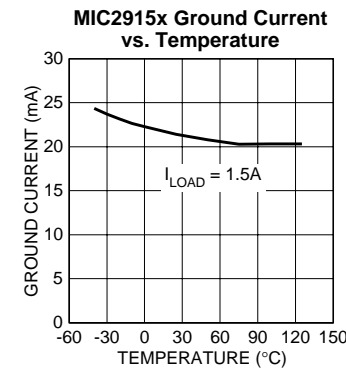
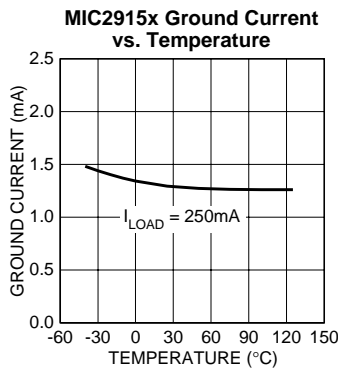
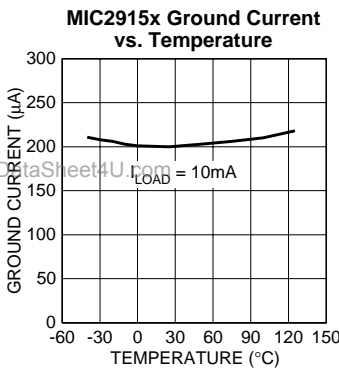
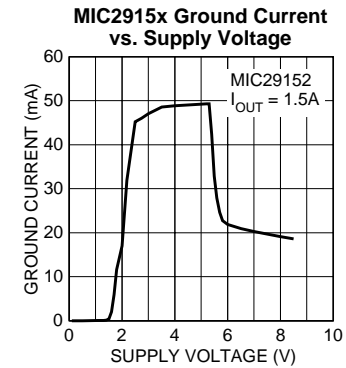
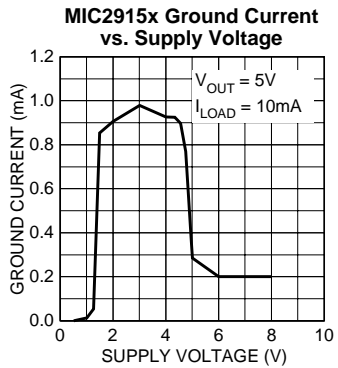
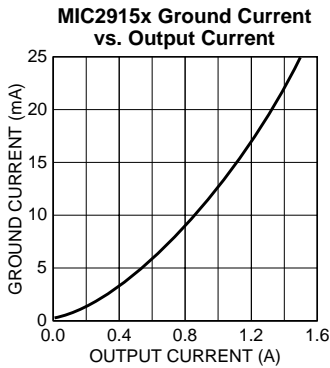
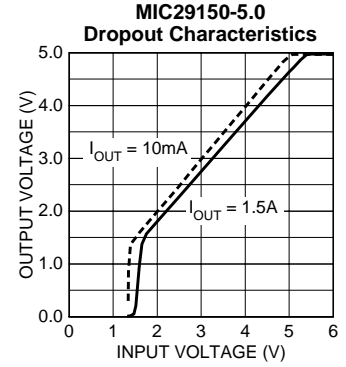
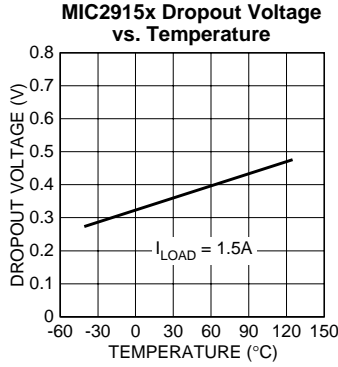
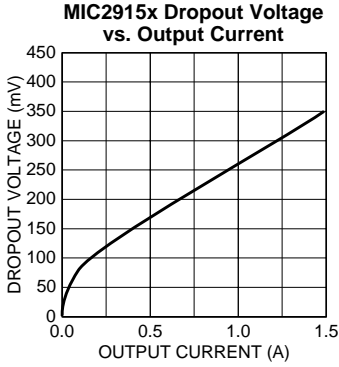
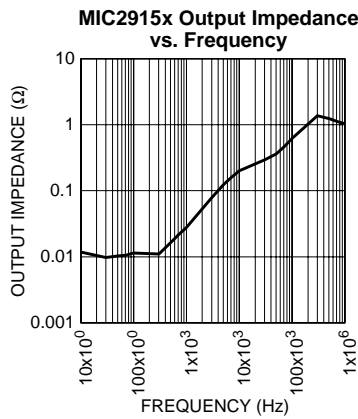
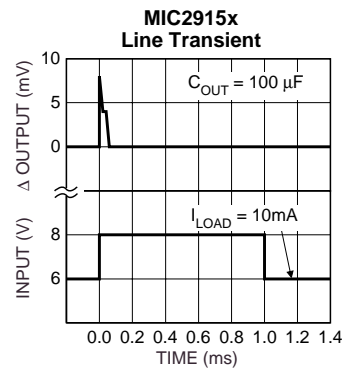
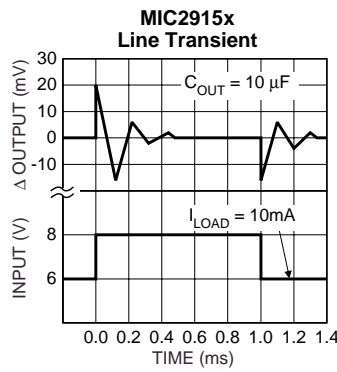
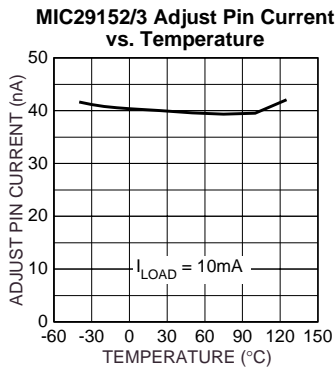
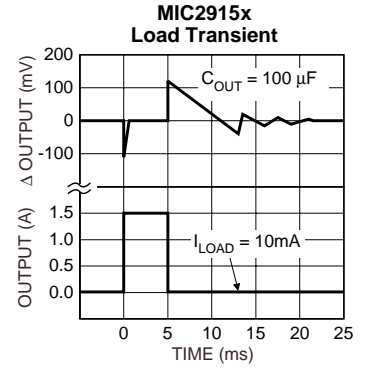
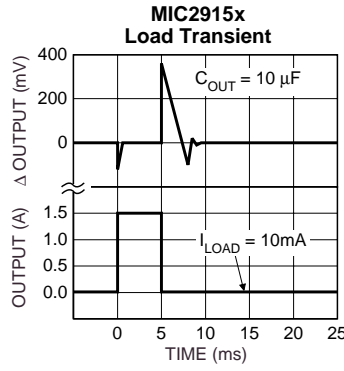
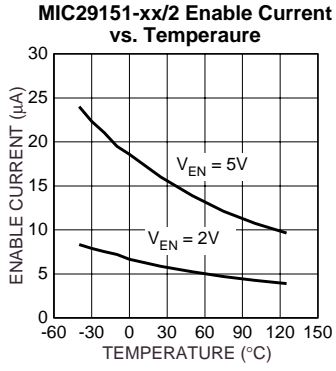

Figure 2. Adjustable output voltage configuration. For best results, the total series resistance should be small enough to pass the minimum regulator load current.

# Typical Characteristics MIC2915x





# Typical Characteristics MIC2930x

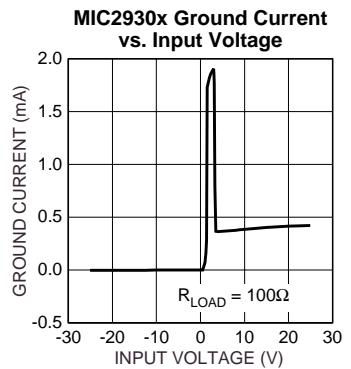
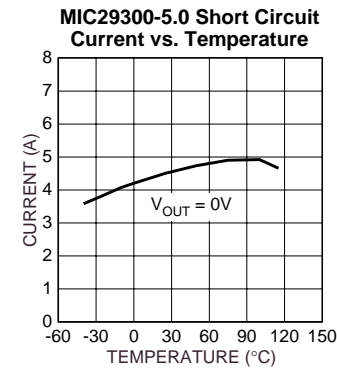
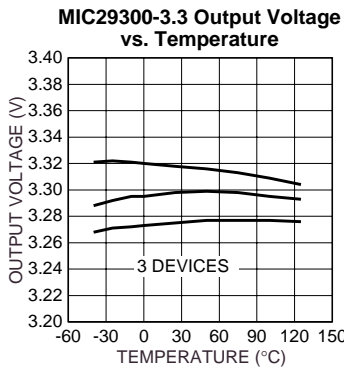
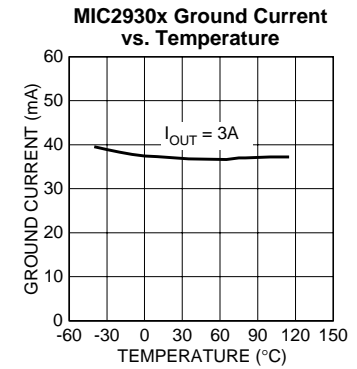
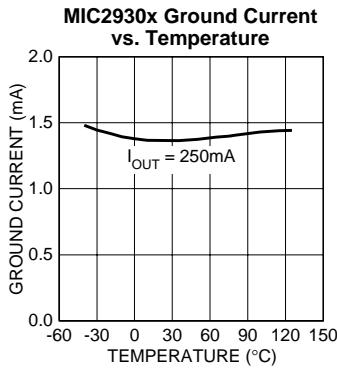
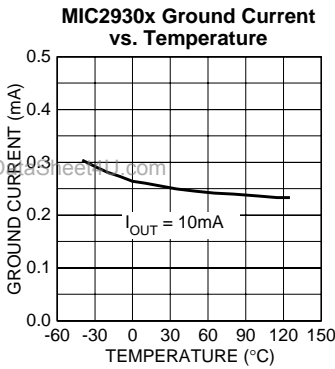
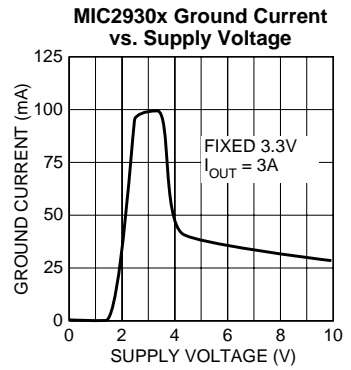
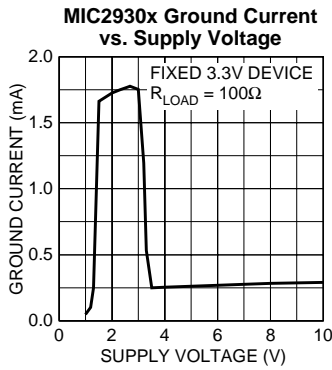
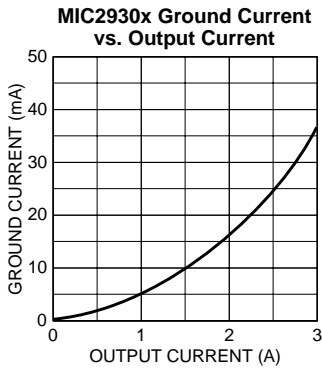
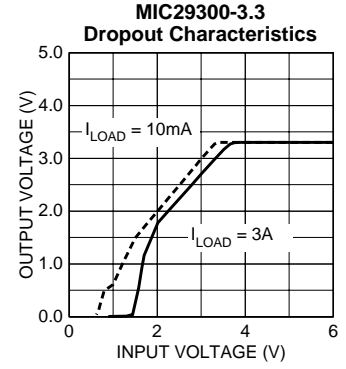
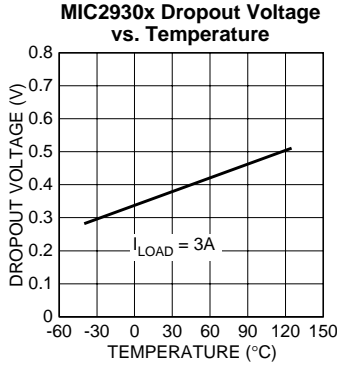
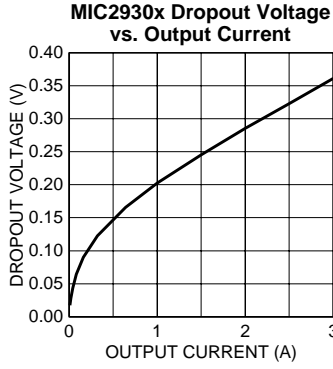



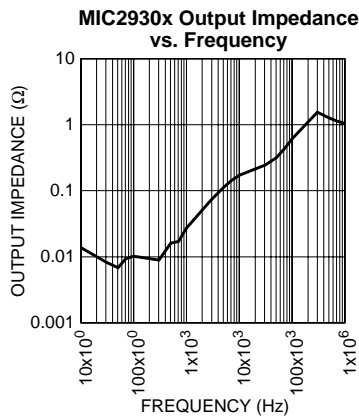
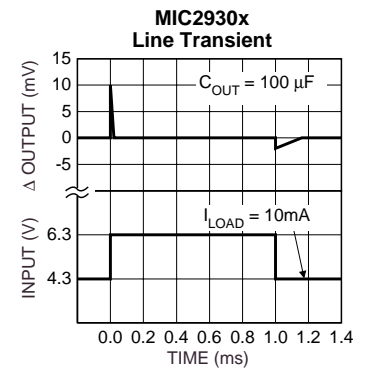
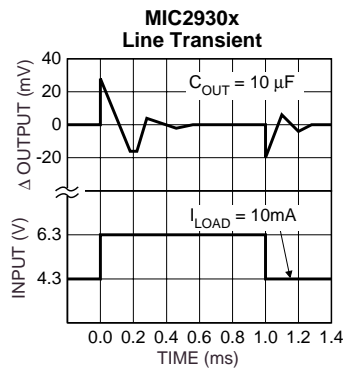
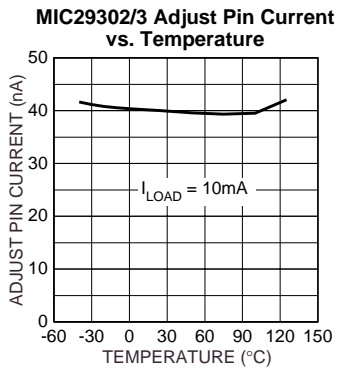
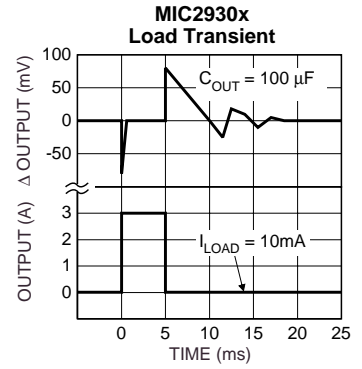
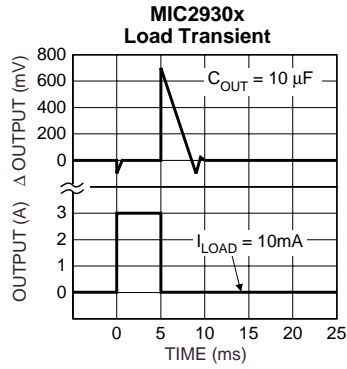
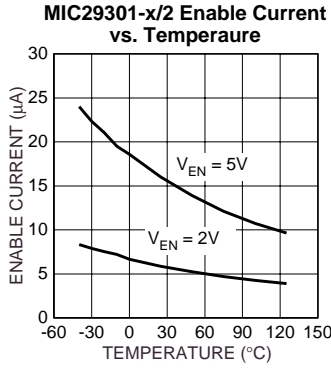

www.DataSheet4U.com

# Typical Characteristics MIC2950x

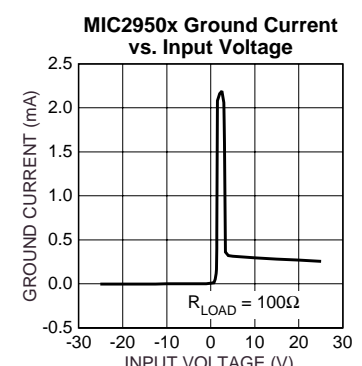
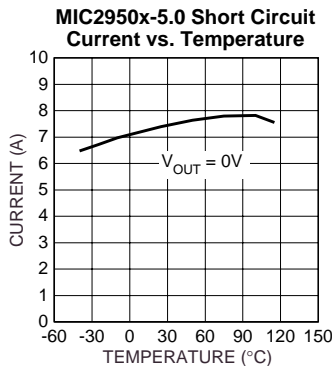
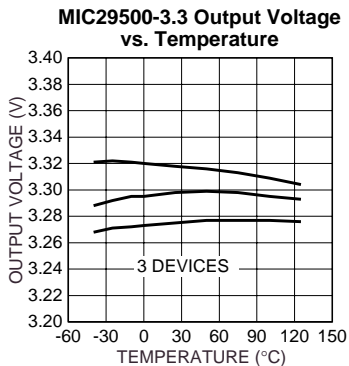
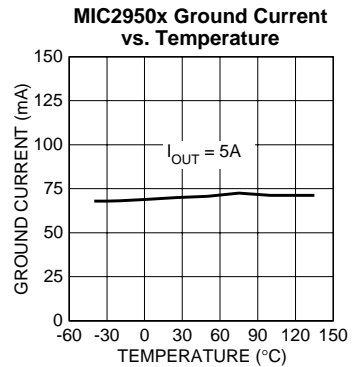
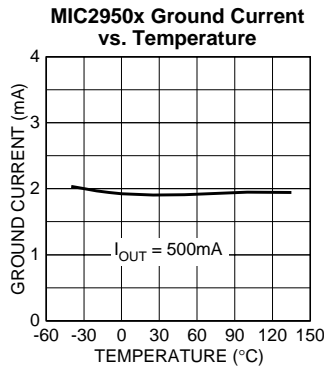
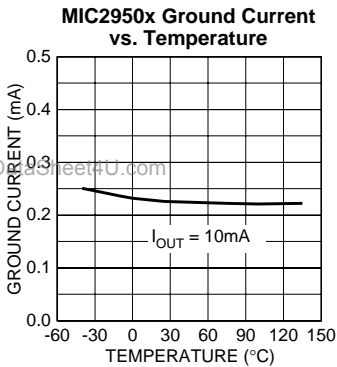
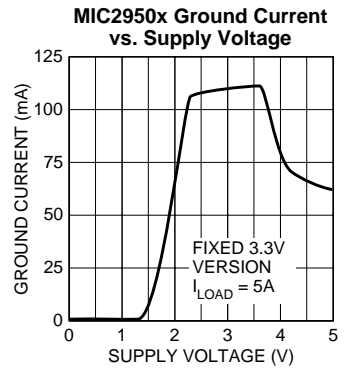
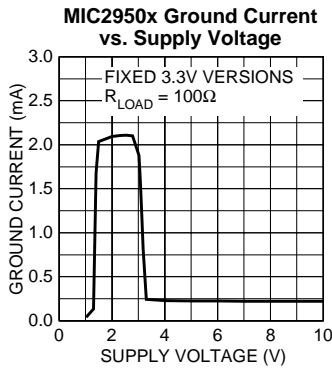
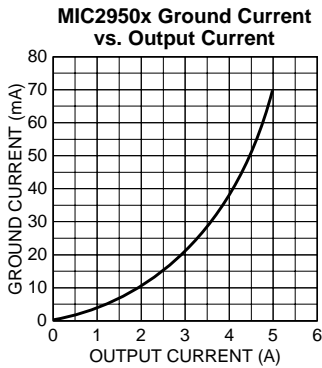
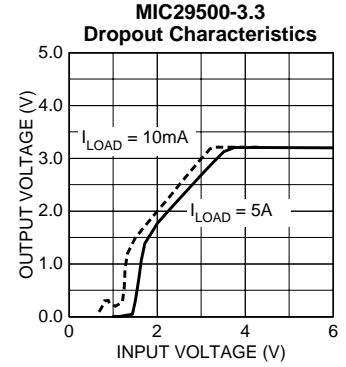
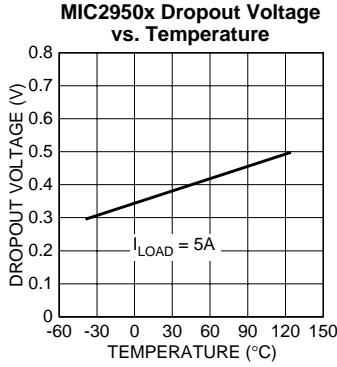
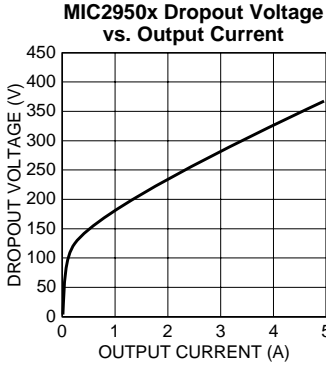

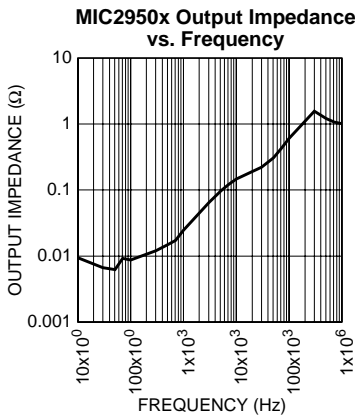
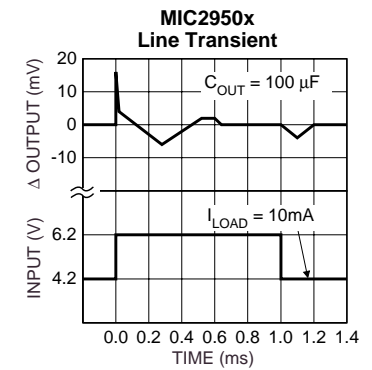
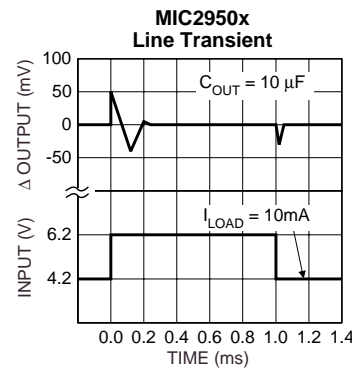
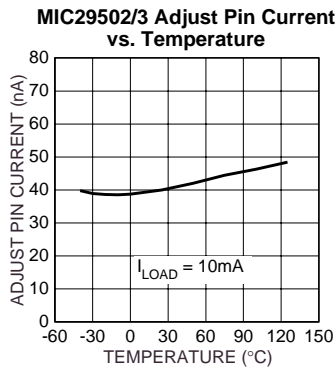
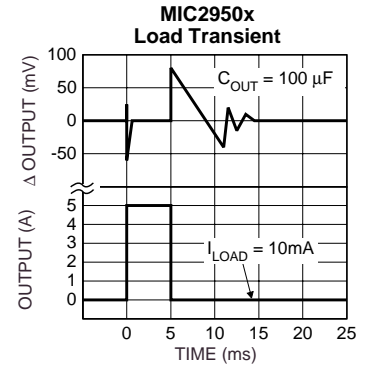
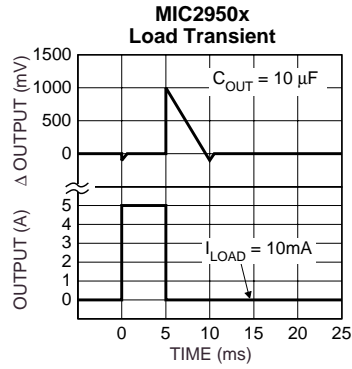
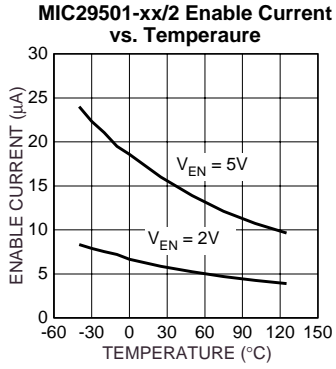

# Typical Characteristics MIC2975x

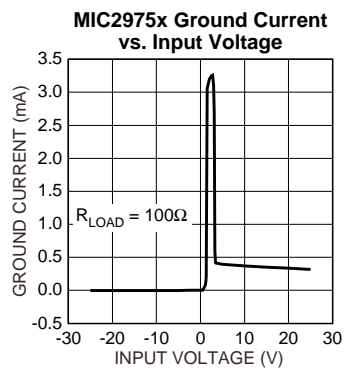
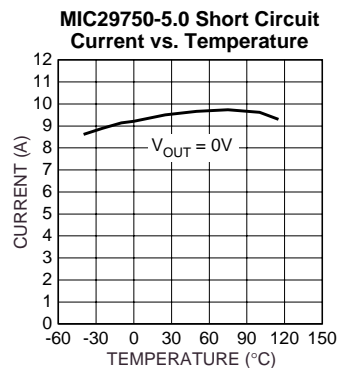
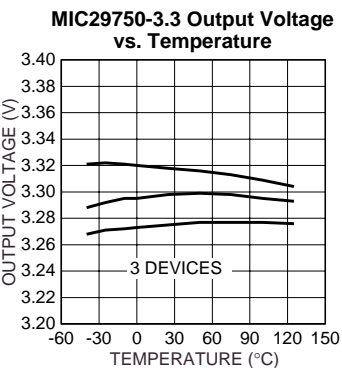
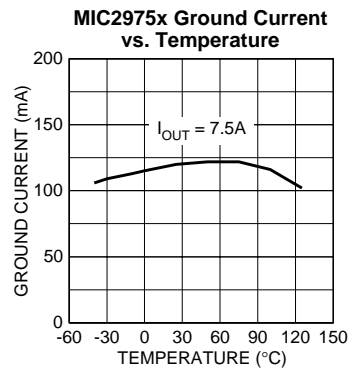
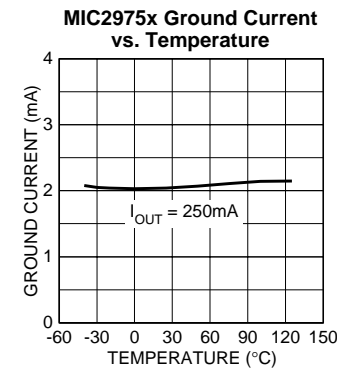
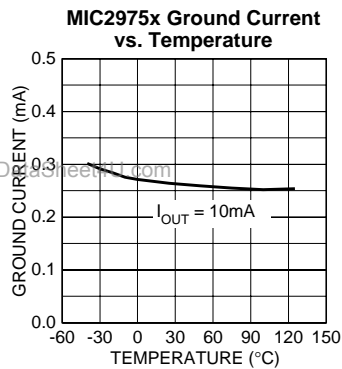
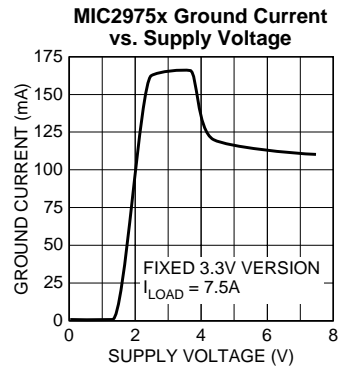
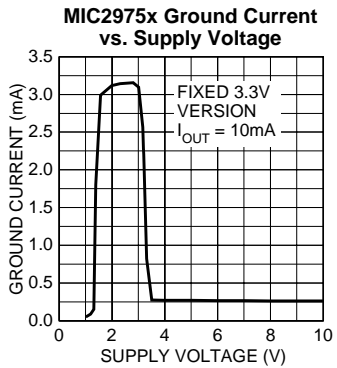
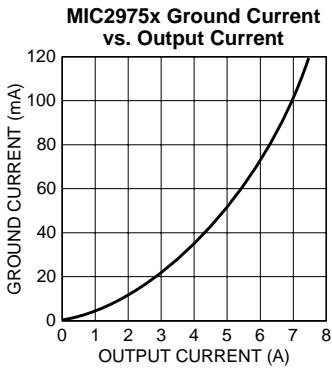
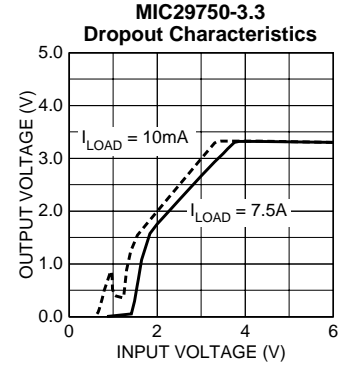
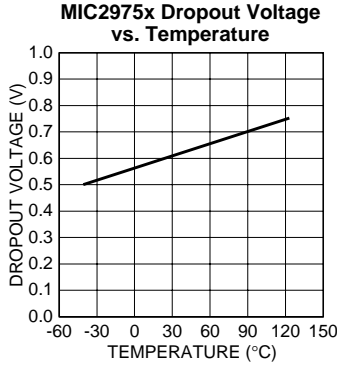
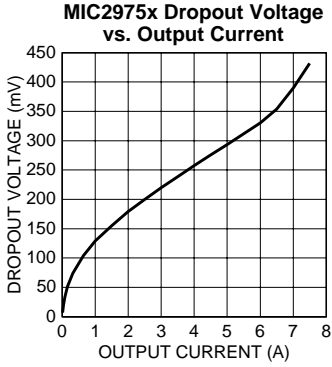

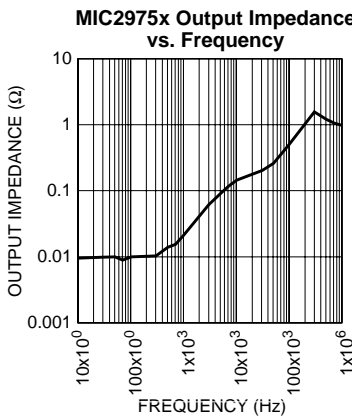
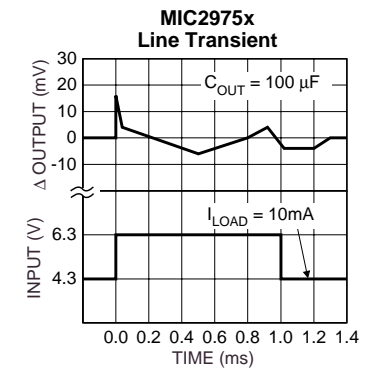
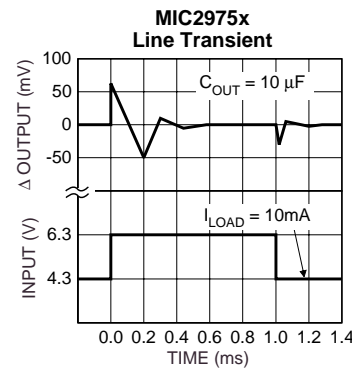
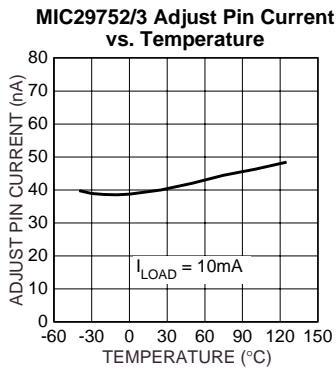
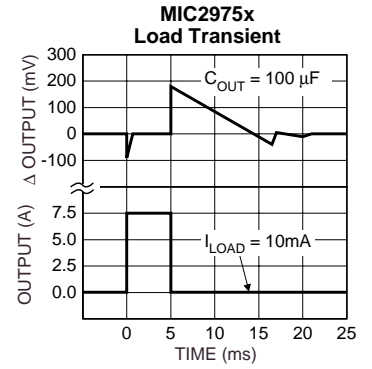
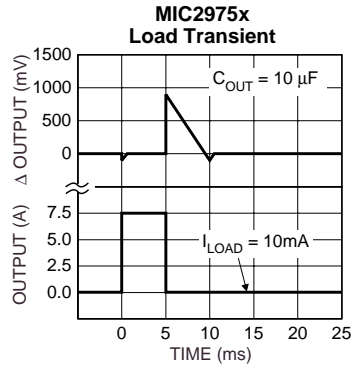
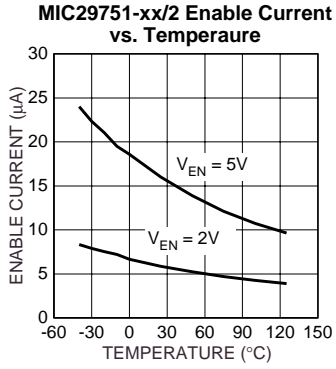

## Applications Information

The MIC29150/29300/29500/29750 are high performance low-dropout voltage regulators suitable for all moderate to high-current voltage regulator applications. Their 300mV to 400mV dropout voltage at full load make them especially valuable in battery powered systems and as high efficiency noise filters in “post-regulator” applications. Unlike older NPN-pass transistor designs, where the minimum dropout voltage is limited by the base-emitter voltage drop and collector-emitter saturation voltage, dropout performance of the PNP output of these devices is limited merely by the low  $V_{CE}$  saturation voltage.

A trade-off for the low dropout voltage is a varying base drive requirement. But Micrel's Super  $\beta$  PNP™ process reduces this drive requirement to merely 1% of the load current.

The MIC29150–29750 family of regulators is fully protected from damage due to fault conditions. Current limiting is provided. This limiting is linear; output current under overload conditions is constant. Thermal shutdown disables the device when the die temperature exceeds the 125°C maximum safe operating temperature. Transient protection allows device (and load) survival even when the input voltage spikes between –20V and +60V. When the input voltage exceeds about 35V to 40V, the overvoltage sensor temporarily disables the regulator. The output structure of these regulators allows voltages in excess of the desired output voltage to be applied without reverse current flow. MIC29xx1 and MIC29xx2 versions offer a logic level ON/OFF control: when disabled, the devices draw nearly zero current.

An additional feature of this regulator family is a common pinout: a design's current requirement may change up or down yet use the same board layout, as all of these regulators have identical pinouts.

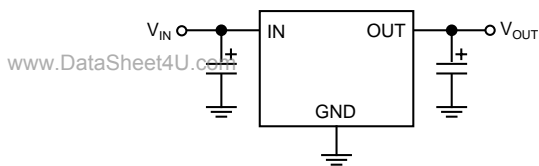

**Figure 3. Linear regulators require only two capacitors for operation.**

### Thermal Design

Linear regulators are simple to use. The most complicated design parameters to consider are thermal characteristics. Thermal design requires the following application-specific parameters:

- Maximum ambient temperature,  $T_A$
- Output Current,  $I_{OUT}$
- Output Voltage,  $V_{OUT}$
- Input Voltage,  $V_{IN}$

First, we calculate the power dissipation of the regulator from these numbers and the device parameters from this datasheet.

$$P_D = I_{OUT} (1.01 V_{IN} - V_{OUT})$$

Where the ground current is approximated by 1% of  $I_{OUT}$ . Then the heat sink thermal resistance is determined with this formula:

$$\theta_{SA} = \frac{T_{JMAX} - T_A}{P_D} - (\theta_{JC} + \theta_{CS})$$

Where  $T_{JMAX} \leq 125^\circ\text{C}$  and  $\theta_{CS}$  is between 0 and  $2^\circ\text{C/W}$ .

The heat sink may be significantly reduced in applications where the minimum input voltage is known and is large compared with the dropout voltage. Use a series input resistor to drop excessive voltage and distribute the heat between this resistor and the regulator. The low dropout properties of Micrel Super  $\beta$  PNP regulators allow very significant reductions in regulator power dissipation and the associated heat sink without compromising performance. When this technique is employed, a capacitor of at least 0.1 $\mu\text{F}$  is needed directly between the input and regulator ground.

Please refer to Application Note 9 and Application Hint 17 for further details and examples on thermal design and heat sink specification.

### Capacitor Requirements

For stability and minimum output noise, a capacitor on the regulator output is necessary. The value of this capacitor is dependent upon the output current; lower currents allow smaller capacitors. MIC29150–29750 regulators are stable with the following minimum capacitor values at full load:

| Device         | Full Load Capacitor |
|----------------|---------------------|
| MIC29150 ..... | 10 $\mu\text{F}$    |
| MIC29300 ..... | 10 $\mu\text{F}$    |
| MIC29500 ..... | 10 $\mu\text{F}$    |
| MIC29750 ..... | 22 $\mu\text{F}$    |

This capacitor need not be an expensive low ESR type: aluminum electrolytics are adequate. In fact, extremely low ESR capacitors may contribute to instability. Tantalum capacitors are recommended for systems where fast load transient response is important.

Where the regulator is powered from a source with a high AC impedance, a 0.1 $\mu\text{F}$  capacitor connected between Input and GND is recommended. This capacitor should have good characteristics to above 250kHz.

### Minimum Load Current

The MIC29150–29750 regulators are specified between finite loads. If the output current is too small, leakage currents dominate and the output voltage rises. The following minimum load current swamps any expected leakage current across the operating temperature range:

| Device         | Minimum Load |
|----------------|--------------|
| MIC29150 ..... | 5mA          |
| MIC29300 ..... | 7mA          |
| MIC29500 ..... | 10mA         |
| MIC29750 ..... | 10mA         |

### Adjustable Regulator Design

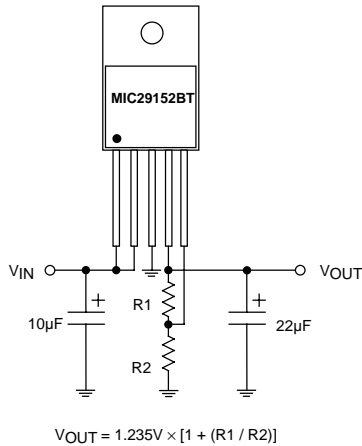

**Figure 4. Adjustable Regulator with Resistors**

The adjustable regulator versions, MIC29xx2 and MIC29xx3, allow programming the output voltage anywhere between 1.25V and the 26V maximum operating rating of the family.

Two resistors are used. Resistors can be quite large, up to 1MΩ, because of the very high input impedance and low bias current of the sense comparator: The resistor values are calculated by:

$$R_1 = R_2 \left( \frac{V_{OUT}}{1.240} - 1 \right)$$

Where  $V_O$  is the desired output voltage. Figure 4 shows component definition. Applications with widely varying load currents may scale the resistors to draw the minimum load current required for proper operation (see above).

### Error Flag

MIC29xx1 and MIC29xx3 versions feature an Error Flag, which looks at the output voltage and signals an error condition when this voltage drops 5% below its expected value. The error flag is an open-collector output that pulls low under fault conditions. It may sink 10mA. Low output voltage signifies a number of possible problems, including an over-current fault (the device is in current limit) and low input voltage. The flag output is inoperative during overtemperature shutdown conditions.

### Enable Input

MIC29xx1 and MIC29xx2 versions feature an enable (EN) input that allows ON/OFF control of the device. Special design allows “zero” current drain when the device is disabled—only microamperes of leakage current flows. The EN input has TTL/CMOS compatible thresholds for simple interfacing with logic, or may be directly tied to  $\leq 30V$ . Enabling the regulator requires approximately 20µA of current.





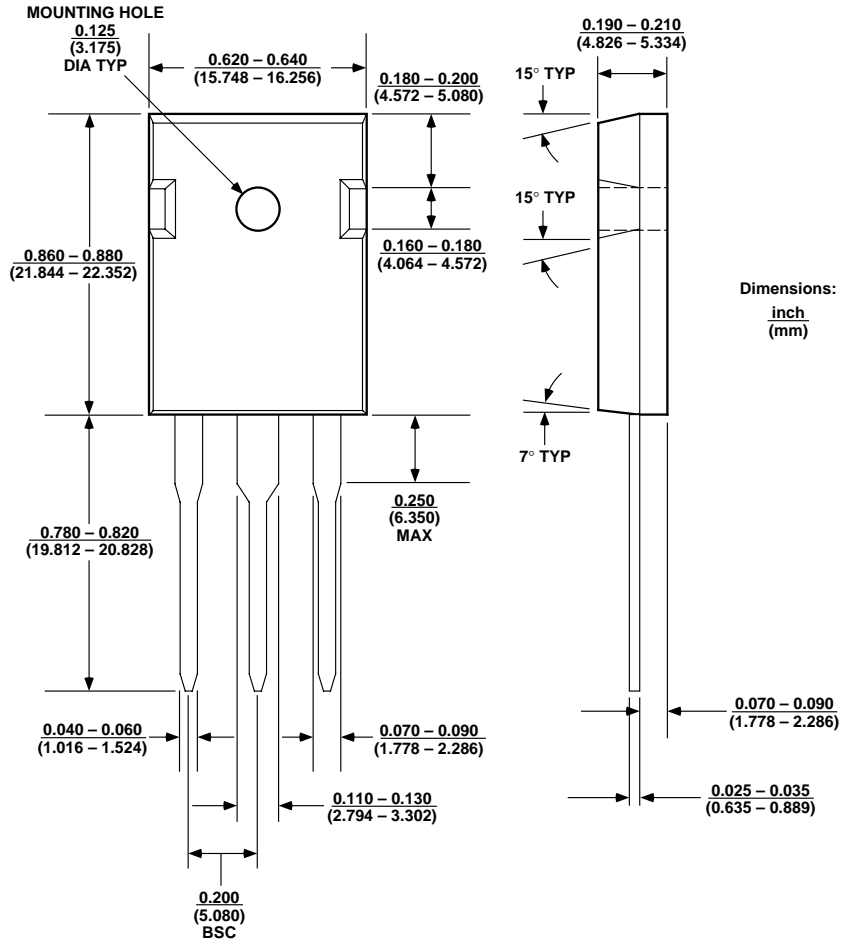

3-Lead TO-247 (WT)

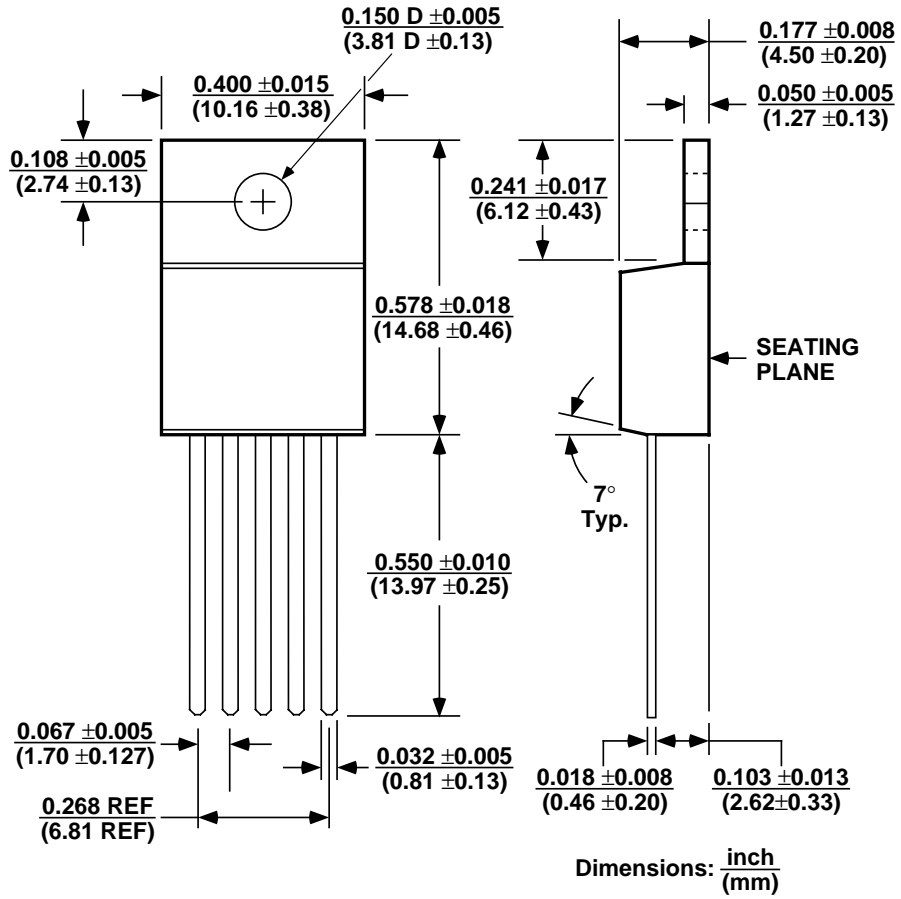

5-Lead TO-220 (T)

www.DataSheet4U.com

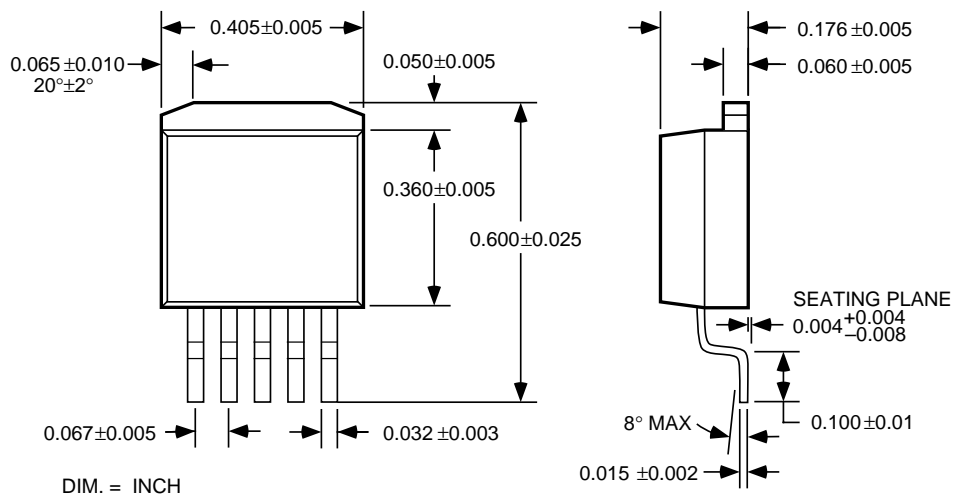

5-Lead TO-263 (U)

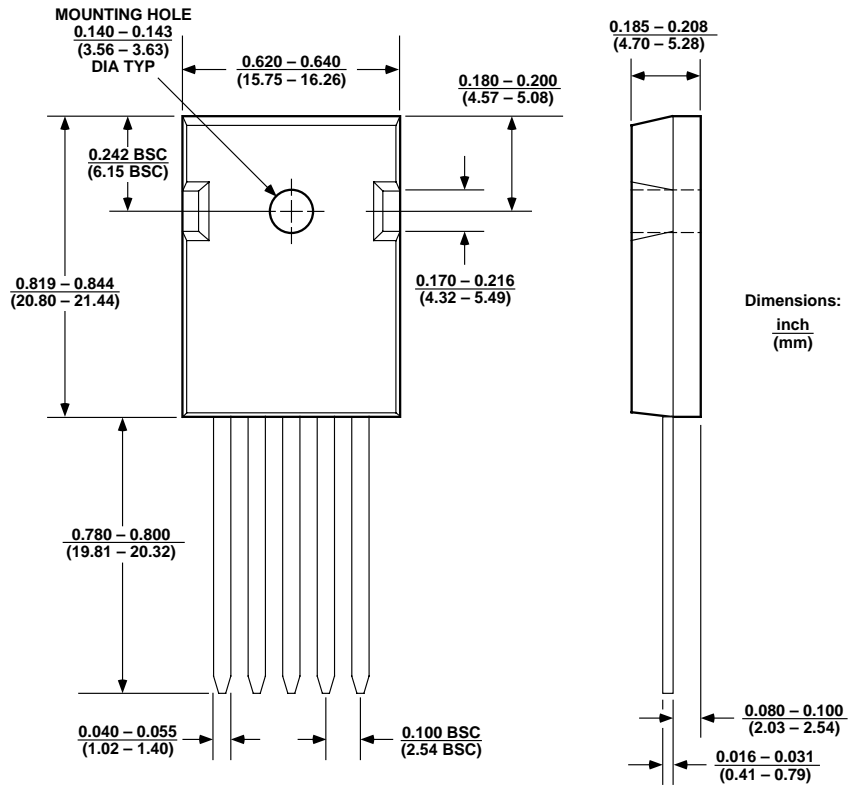

5-Lead TO-247 (WT)

www.DataSheet4U.com

---

**MICREL INC. 1849 FORTUNE DRIVE SAN JOSE, CA 95131 USA**

TEL + 1 (408) 944-0800 FAX + 1 (408) 944-0970 WEB <http://www.micrel.com>

This information is believed to be accurate and reliable, however no responsibility is assumed by Micrel for its use nor for any infringement of patents or other rights of third parties resulting from its use. No license is granted by implication or otherwise under any patent or patent right of Micrel Inc.

© 2000 Micrel Incorporated