

TOSHIBA

FILE NO. 060-200563GR

SERVICE MANUAL

Color Television

S5SS series

29CZ8URB
29CZ8URS

The above models are classified as green products (*1), as indicated by the underlined serial numbers. This Service Manual describes replacement parts for the green products. When repairing these green product (s), use the part (s) described in this manual and lead-free solder (*2).

For (*1) and (*2), see the next page.

TABLE OF CONTENTS

CHAPTER 1 GENERAL ADJUSTMENTS

SAFETY INSTRUCTIONS	3
SET-UP ADJUSTMENT	4
SERVICE MODE	6
DESIGN MODE	8
ELECTRICAL ADJUSTMENTS	9
CIRCUIT CHECK	14

CHAPTER 2 SPECIFIC INFORMATIONS

SETTING & ADJUSTING DATA	15
LOCATION OF CONTROLS	16
PROGRAMMING CHANNEL MEMORY	17
CHASSIS AND CABINET REPLACEMENT PARTS LIST	19
PC BOARDS TOP & BOTTOM VIEW	30
TERMINAL VIEW OF TRANSISTORS	38
CIRCUIT BLOCK DIAGRAM	40
SPECIFICATIONS	END

APPENDIX:

CIRCUIT DIAGRAM

(*1)

GREEN PRODUCT PROCUREMENT

The EC is actively promoting the WEEE & RoHS Directives that define standards for recycling and reuse of Waste Electrical and Electronic Equipment and for the Restriction of the use of certain Hazardous Substances. From July 1, 2006, the RoHS Directive will prohibit any marketing of new products containing the restricted substances.

Increasing attention is given to issues related to the global environmental. Toshiba Corporation recognizes environmental protection as a key management tasks, and is doing its utmost to enhance and improve the quality and scope of its environmental activities. In line with this, Toshiba proactively promotes Green Procurement, and seeks to purchase and use products, parts and materials that have low environmental impacts.

Green procurement of parts is not only confined to manufacture. The same green parts used in manufacture must also be used as replacement parts.

(*2)

LEAD-FREE SOLDER

This product is manufactured using lead-free solder as a part of a movement within the consumer products industry at large to be environmentally responsible. Lead-free solder must be used in the servicing and repair of this product.

WARNING

This product is manufactured using lead free solder.

DO NOT USE LEAD BASED SOLDER TO REPAIR THIS PRODUCT!

The melting temperature of lead-free solder is higher than that of leaded solder by 86°F to 104°F (30°C to 40°C). Use of a soldering iron designed for lead-based solders to repair product made with lead-free solder may result in damage to the component and or PCB being soldered. Great care should be made to ensure high-quality soldering when servicing this product -especially when soldering large components, through-hole pins, and on PCBs - as the level of heat required to melt lead-free solder is high.

CHAPTER 1 GENERAL ADJUSTMENTS

SAFETY INSTRUCTIONS

WARNING: BEFORE SERVICING THIS CHASSIS, READ THE "X-RAY RADIATION PRECAUTION", "SAFETY PRECAUTION" AND "PRODUCT SAFETY NOTICE" INSTRUCTIONS BELOW.

X-RAY RADIATION PRECAUTION

1. Excessive high voltage can produce potentially hazardous X-RAY RADIATION. To avoid such hazards, the high voltage must not be above the specified limit. The nominal value of the high voltage of this receiver is (A) kV at zero beam current (minimum brightness) under a (C) V AC power source. The high voltage must not, under any circumstances, exceed (B) kV.
2. The only source of X-RAY RADIATION in this TV receiver is the picture tube. For continued X-RAY RADIATION protection, the replacement tube must be exactly the same type tube as specified in the parts list.
3. Some part in this receiver have special safety-related characteristics for X-RAY RADIATION protection. For continued safety, parts replacement should be undertaken only after referring to the PRODUCT SAFETY NOTICE below.

Refer to table-1 for high voltage (A), (B) & AC voltage (C).
(See SETTING & ADJUSTING DATA on page 15)

Each time a receiver requires servicing, the high voltage should be checked following the HIGH VOLTAGE CHECK procedure in this manual. It is recommended that the reading of the high voltage be recorded as a part of the service record. It is important to use an accurate and reliable high voltage meter.

SAFETY PRECAUTION

WARNING : Service should not be attempted by anyone unfamiliar with the necessary precautions on this receiver. The following are the necessary precautions to be observed before servicing this chassis.

1. An isolation transformer should be connected in the power line between the receiver and the AC line before any service is performed on the receiver.
2. Always discharge the picture tube anode to the CRT conductive coating before handling the picture tube. The picture tube is highly evacuated and if broken, glass fragments will be violently expelled. Use shatter proof goggles and keep picture tube away from the unprotected body while handling.
3. When replacing a chassis in the cabinet, always be certain that all the protective devices are put back in place, such as; nonmetallic control knobs, insulating covers, shields, isolation resistor-capacitor network etc.

PRODUCT SAFETY NOTICE

Many electrical and mechanical parts in this chassis have special safety-related characteristics. These characteristics are often passed unnoticed by a visual inspection and the protection afforded by them cannot necessarily be obtained by using replacement components rated for higher voltage, wattage, etc. Replacement parts which have these special safety characteristics are identified in this manual and its supplements; electrical components having such features are identified by the international hazard symbols on the schematic diagram and the parts list.

Before replacing any of these components, read the parts list in this manual carefully. The use of substitute replacement parts which do not have the same safety characteristics as specified in the parts list may create shock, fire, X-ray radiation or other hazards.

WARNING: BEFORE SERVICING THIS CHASSIS, READ THE "X-RAY RADIATION PRECAUTION", "SAFETY PRECAUTION" AND "PRODUCT SAFETY NOTICE" ON PAGE 3 OF THIS MANUAL.

SET-UP ADJUSTMENT

- The following adjustments should be made when a complete realignment is required or a new picture tube is installed. Perform the adjustments in order as follows :

1. Color Purity
2. Convergence
3. White Balance

Note: The PURITY/CONVERGENCE MAGNET assembly and rubber wedges need mechanical positioning.

Refer to figure 1.

Mounting position of the purity magnet assembly should fit to same position as old one because slightly difference to the position depend on a kind of tube.

COLOR PURITY ADJUSTMENT

- (1) Let the screen face in the installing direction or toward the east (when it is to be moved), bring up the service mode screen after demagnetizing (front, left, right, and top) with the degaussing coil, receive white signals by pressing the \odot button, and then the receiver should be operated for more than 40 minutes.
- (2) Perform rough adjustment of the central convergence with the P/C magnet according to the adjustment item.
- (3) Receive built-in green signals, loosen set screws on the deflection yoke, remove rubber wedges, and shift the deflection yoke toward front.
- (4) Move alternately the two 2-pole magnets of the P/C magnets so that the green raster can come to the center of the screen.

Figure 1.

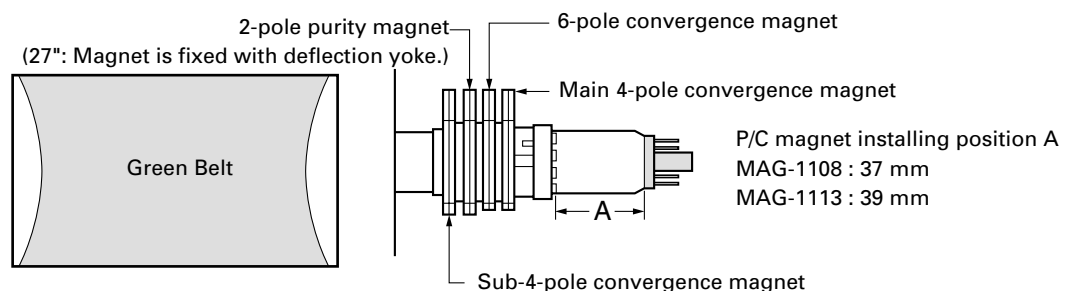

- (5) Receive built-in red and blue signals, check that there is no inclination of the single color raster toward one side, and if each color tilts to a great extent, make adjustment with the 2-pole magnet so that the 3 colors will come to the center evenly.
- (6) Receive the green raster, shift the deflection yoke from a foremost position (hitting against the picture tube) to a backward position horizontally, stop the deflection yoke at a position where it begins to become a green raster, and perform accurate marking on the picture tube.
- (7) Shift the deflection yoke further backward, and perform accurate marking at a position where the green raster begins to be blurry.
- (8) Fix the deflection yoke at a position 60% forward within the range marked in items (6) and (7) above.

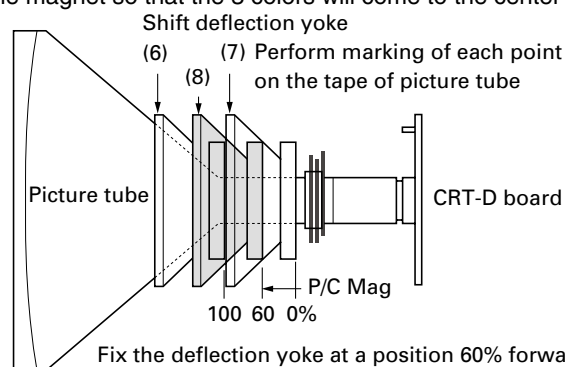

CONVERGENCE ADJUSTMENTS

* Adjust the convergence magnet to get best convergence in the order to (1) ~ (5).

■ CENTER CONVERGENCE:

- (1) Receive the white crosshatch or dot pattern from the service signal generator.
- (2) Use the 2 pieces of main 4-pole magnets of P/C magnets, change the open angle, and align the red and blue vertical lines on the screen center.
- (3) Freeze the open angle of the main 4-pole magnets, turn them simultaneously, and align the horizontal lines.
- (4) Take the same steps for items (2) and (3) above and align red/blue with green on the screen center using two 6-pole magnets.

(5) Adjust the sub-4-pole magnets only in case there is any deviation of Xv bow-shaped convergence. (To be usually set at the initial position)

Align both sides with the sub-4-pole magnets and minimize the deviation of blue and red with the main 4-pole magnets.

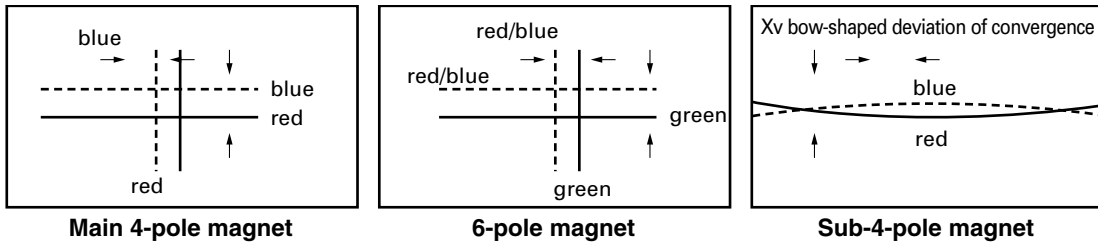

■ CIRCUMFERENCE CONVERGENCE ADJUSTMENT

* Perform correction in the following manner.

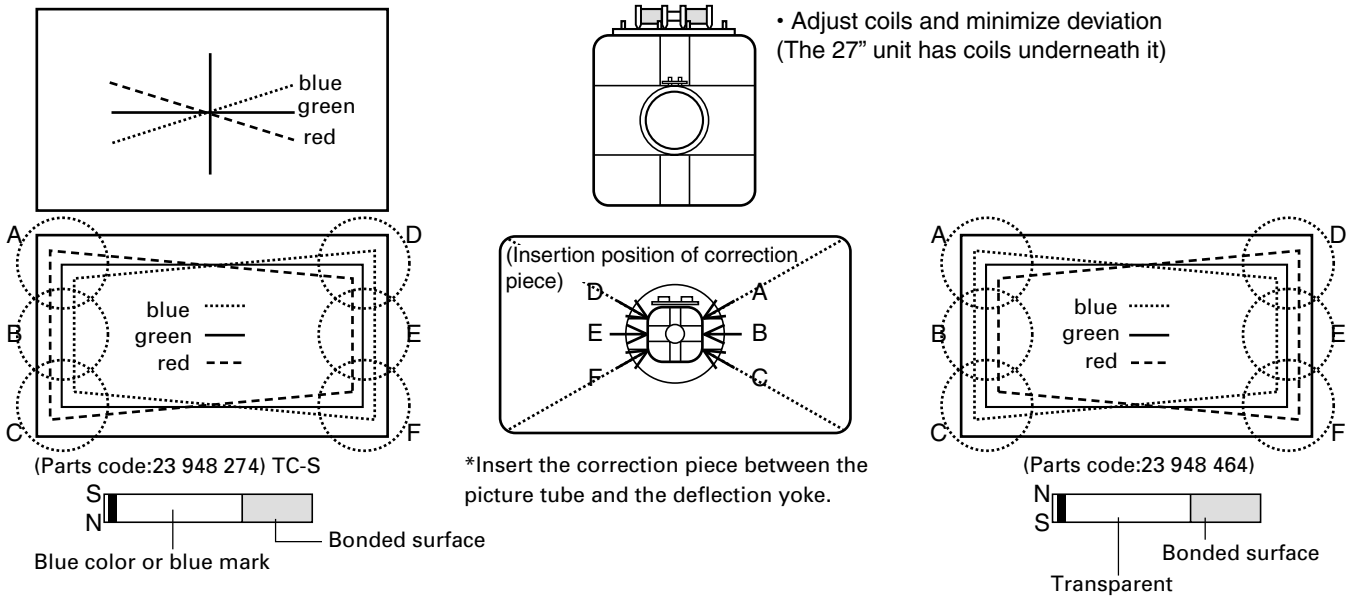

Adjust (YHC) and minimize the deviation of YH.

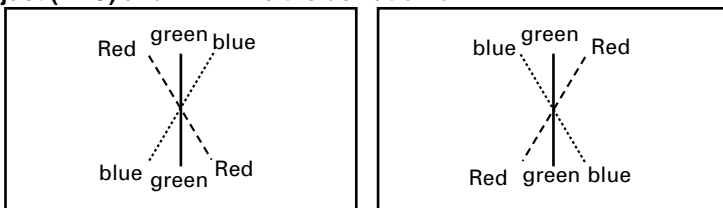

Adjust (YV) and minimize the deviation of YV.

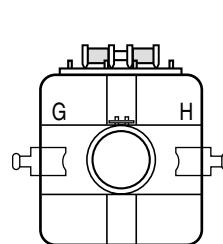
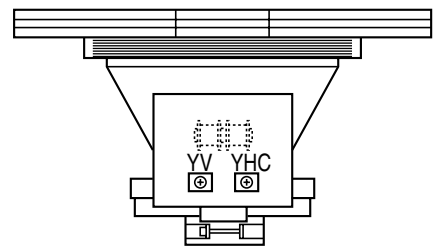
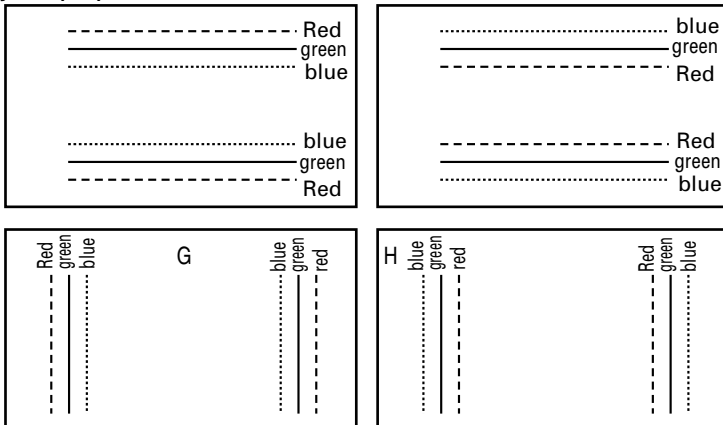

Perform correction by inserting the correction piece into the clearance of terminal board coils of the deflection yoke.

Note:
Perform insertion by turning the metal side to the terminal board side of the deflection yoke.

SERVICE MODE

1. ENTERING TO SERVICE MODE

1) Press  button once on Remote Control.

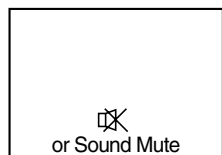

2) Press  button again to keep pressing.

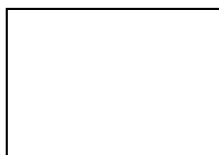

3) While pressing the  button, press MENU button on TV set.

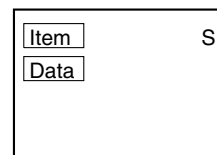

(Service mode display)

2. DISPLAYING THE ADJUSTMENT MENU

1) Press MENU button on TV.

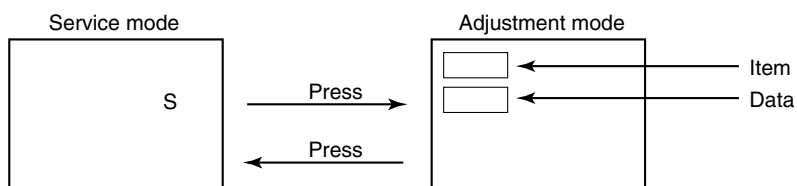

3. KEY FUNCTION IN THE SERVICE MODE

The following key entry during display of adjustment menu provides special functions.

Screen adjustment mode ON/OFF:

-/- button (on Remote)

Test signal selection :

 button (on Remote)

Selection of the adjustment items :

CH ▲/▼ (on TV or Remote)

Change of the data value :

▲ +/- (on TV or Remote)

Adjustment menu mode ON/OFF :

MENU button (on TV)

Initialization of the memory (QA02) :

CALL +  ▲ (on TV)

Reset the count of operating protect circuit to "00":

CALL +  ▼ (on TV)

"RCUT" selection :

1 button

"GCUT" selection :

2 button

"BCUT" selection :

3 button

"SCNT" selection :

4 button

"CLPI" selection :

5 button - - - - - Color thickness correction

"TNTC" selection :

6 button

"OPT0" selection :

YELLOW button

note: Displayed differently as shown below, depending on the setting of the receiving color system.

Self diagnostic display ON/OFF :

9 button

COLP (PAL)
COLC (NTSC)
COLS (SECAM)

CAUTION : Never try to perform initialization unless you have changed the memory IC.

4. SELECTING THE ADJUSTING ITEMS

- 1) Every pressing of CH ▲ button in the service mode changes the adjustment items in the order of table-2.
(▼ button for reverse order)

Refer to table-2 for preset data of adjustment mode.
(See SETTING & ADJUSTING DATA on page 15)

5. ADJUSTING THE DATA

- 1) Pressing of ▲ +/- button will change the value of data in the range from 00H to FFH. The variable range depends on the adjusting item.

6. EXIT FROM SERVICE MODE

- 1) Press POWER button to turn off the TV once.

■ INITIALIZATION OF MEMORY DATA OF QA02

After replacing QA02, the following initialization is required.

1. Enter the service mode, then select any register item.
2. Press and hold the CALL button on the Remote, then press the CH ▲ button on the TV. The initialization of QA02 has been completed.
3. Check the picture carefully. If necessary, adjust any adjustment item above.
Perform "Auto tune" on the owner's manual.

CAUTION: Never attempt to initialize the data unless QA02 has been replaced.

7. TEST SIGNAL SELECTION

- 1) Every pressing of ⏪ button on the Remote Control changes the built-in test patterns on screen as described below in SERVICE MODE.

Signal off ← → ALL White

Signals	Picture
• All White	

8. SELF CHECK FUNCTION

- 1) Press "9" button on Remote Control during display of adjustment menu in the service mode.
The diagnosis will begin to check if interface among IC's are executed properly.
- 2) During diagnosis, the following displays are shown.

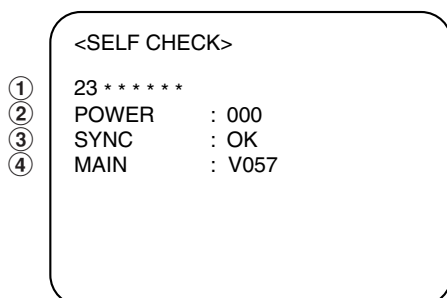

- ① Part number of microprocessor (QA01)
- ② Operation number of protecting circuit ----"000" is normal.
- ③ RF signal center frequency is locked.
- ④ Version information of microprocessor

DESIGN MODE

1. ENTERING TO DESIGN MODE

- 1) Select the Service mode. (See page 6)
- 2) While pressing CALL button on Remote and press MENU button on TV.
- 3) Press MENU button on TV.

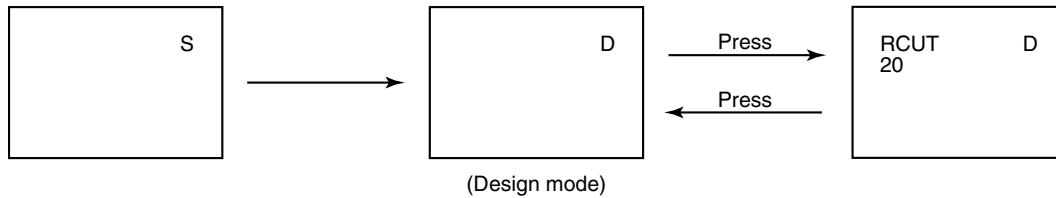

2. SELECTING THE ADJUSTING ITEMS

Every pressing of CH ▼ button in the design mode changes the adjustment items in the order of table-3. (▲ button for reverse order)

Refer to table-3 for data of design mode.
(See SETTING & ADJUSTING DATA on page 15)

3. ADJUSTING THE DATA

Pressing of ▲/▼ button will change the value of data.

ELECTRICAL ADJUSTMENTS

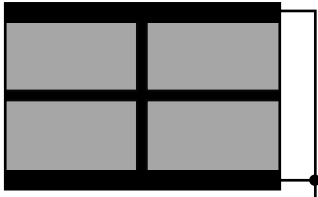
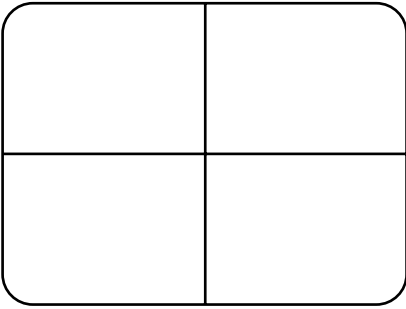
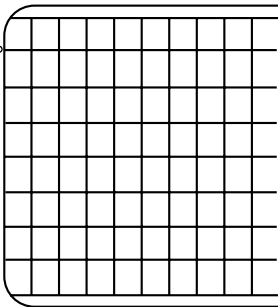
ITEM	ADJUSTMENT PROCEDURE
<p>FOCUS VR ADJ</p>	<ol style="list-style-type: none"> 1. Enter the service mode, then select any register item. 2. Press the \ominus button on the Remote until the black cross-bar pattern appears on the screen. 3. Adjust the FOCUS control (on T461) for well defined scanning lines on the picture screen.
<p>SUB-BRIGHTNESS (BRTC)</p> <p>Note: Constrict the picture height until the vertical retrace line appears adjusting the item HIT (HEIGHT).</p>	<ol style="list-style-type: none"> 1. Set CONTRAST to minimum, and BRIGHTNESS to center by adjusting user controls. 2. Set the TV in service mode to get Black cross-bar of inside pattern. 3. Select BRTC (brightness correction), and adjust the \triangleleft $-/+$ button to reduce the value so that white portion of inside pattern slightly light. 4. Adjust \triangleleft $-/+$ button to increase the data value of BRTC, and set it just before the difference between the belt of vertical retrace and the border of black portion of inside pattern is visible. <p>After that, return vertical height and contrast.</p> <div style="text-align: right;">  <p>Belt of vertical retrace</p> </div>
<p>HORIZONTAL POSITION ADJUSTMENT (HPOS)</p> <p>VERTICAL POSITION ADJUSTMENT (VPOS)</p>	<ol style="list-style-type: none"> 1. Set the TV in service mode, and get black cross-bar signal with \ominus button on remote hand unit. 2. Select either HPOS (Horizontal picture phase) or VPOS (Vertical picture phase) with CH \blacktriangle, \blacktriangledown buttons, and adjust horizontal or vertical picture position in the center of screen with \triangleleft $-/+$ buttons. <div style="text-align: right;">  </div>
<p>VERTICAL AMPLITUDE ADJUSTMENT (HIT)</p>	<ol style="list-style-type: none"> 1. Set the TV in service mode, and get black cross-hatch signal with \ominus button on remote hand unit. 2. Select HIT (Vertical amplitude) with CH \blacktriangle, \blacktriangledown buttons, and adjust vertical amplitude with \triangleleft $-/+$ buttons so that vertical amplitude lacks a little. 3. Adjust vertical amplitude with \triangleleft $-/+$ buttons so that the first bar on cross-hatch signal touches edge of screen. <div style="text-align: right;">  <p>The first</p> </div>

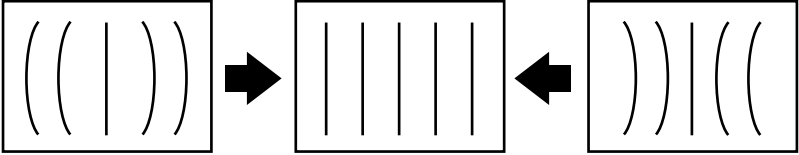
ITEM	ADJUSTMENT PROCEDURE
WIDTH (WID)	<ol style="list-style-type: none"> 1. Call up the adjustment mode display, then select the item WID. 2. Press the \triangle - /+ button to get the picture so the left and right edges of raster begins to lack. 3. Press the \triangle - /+ button to advance the data by 7 steps. Note: Check the horizontal picture position is correct.
E-W PARABOLA (PARA)	<ol style="list-style-type: none"> 1. Call up the adjustment mode display, then select the item PARA. 2. Press the \odot button on Remote until the cross-hatch pattern appears on the screen. 3. Press the \triangle - /+ button to make vertical lines straight as shown below. <div style="text-align: center;">  </div>
WHITE BALANCE ADJUSTMENT • CUTOFF ADJUSTMENT (RCUT) (GCUT) (BCUT) • DRIVE ADJUSTMENT (GDRV) (BDRV)	<ol style="list-style-type: none"> 1. Set Contrast to 40, and brightness to +20 by picture control. 2. Receive the Black and White pattern. 3. Select RCUT, GCUT, BCUT, GDRV and BDRV with CH \blacktriangle, \blacktriangledown buttons. Press volume \triangle - /+ buttons to set individual values to initial reference data. 4. Press \square - /- - button on the remote control and rotate Screen VR to get one slight horizontal line on screen. Note: Every pressing of \square - /- - button provides Horizontal line picture and Normal picture alternately. 5. Press \square - /- - button to release horizontal line picture, and select the two other colors which did not light in the above step with CH \blacktriangle, \blacktriangledown buttons. Then tap \triangle - /+ buttons so that three colors slightly light in the same level. <p>※ To correct white balance in light area, select GDRV and BDRV with CH \blacktriangle, \blacktriangledown buttons to adjust.</p> <p>※ To correct white balance in dark area, perform fine adjustment of RCUT, GCUT and BCUT.</p> <div style="border: 1px solid black; border-radius: 15px; padding: 10px; margin-top: 10px;"> <div style="border: 1px solid black; width: fit-content; margin: 0 auto; padding: 5px;">Light area check (to show white)</div> <div style="text-align: center; margin-top: 20px;">Dark area check (to show black)</div> </div>

V/C system adjustment

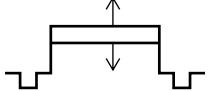
No.	ADJUSTING ITEMS AND POINTS	ADJUSTMENT PROCEDURE	REMARKS
1	Cutoff adjustment and white balance adjustment <div style="border: 1px solid black; padding: 5px; display: inline-block; text-align: center;"> RCUT GCUT BCUT GDRV BDRV </div> <div style="border: 1px solid black; padding: 2px; display: inline-block; margin-top: 10px;">Screen VR</div>	1) Setting to horizontal alignment, turn the screen VR to stop where the brightness lines are slightly luminous. (Adjustment shall be made so that they look almost white.) 2) Cancel horizontal alignment. 3) Varying R, G and B CUTOFF, make white balance adjustment in the dark area. 4) Adjusting G and B DRIVE, make white balance adjustment in the bright area. 5) Repeat procedures 3) and 4) if necessary. Adjustable value: Bright area: 11500K+0.0075uV (103cd/m ²) Dark area: 10500K+0.0105uV (17cd/m ²)	No outside lighting shall be allowed. Measurement shall be performed at the center of CRT. Receiver shall be in the standard state. Total white signal Varying the level of input signal, adjust the brightness. 
2	Sub brightness adjustment (BRTC)	1) Select BRTC in the sub data adjustment mode. Adjust the number of black solid lines to 4 ± 1.5 .	J-2ch sub brightness signal DYNAMIC

Circuit adjustment (Procedure Manual for Deflection Adjustment)

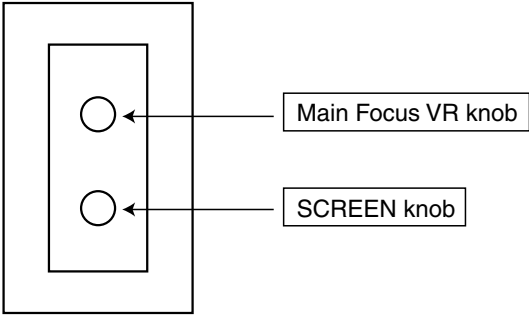
No.	ADJUSTING ITEMS AND POINTS	ADJUSTMENT PROCEDURE
1	Focus Adjustment Main Focus: T461	Conditions : PAL RETMA ch Screen Size : Wide Presentation Mode : Dynamic Only for 29-inch model 1) Adjust the Main Focus VR knob of T461 model to optimize center focus. Refer to the diagram below for the location of the Main Focus VR knob. 

Horizontal adjustment * Deflection adjustment shall be made from PAL/100 Hz/WIDE mode.

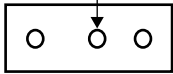
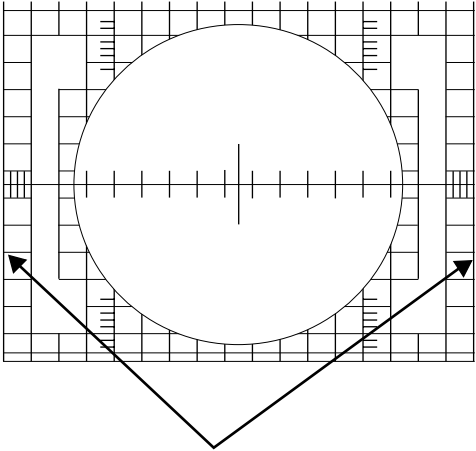
	ADJUSTING ITEMS AND POINTS	ADJUSTMENT PROCEDURE
Horizontal	<p>For PAL/100 Hz/WIDE Horizontal amplitude (WID) Side pin distortion (PARA) Trapezoidal distortion (TRAP) Corner distortion (CNR) Upper corner distortion (TCNR) Lower corner distortion (BCNR) CENT distortion (CPAR) Parallelogrammatic distortion (CSAW) Horizontal phase (HPOS)</p> <p>Note 1: POW/DEF board: P451/M450 Horizontal screen positional switch CENT</p>  <p>Right side Left side</p> <p>Screen position shall be switched by inserting a plug into the above pin. (CENT should take the first stage)</p>	<p><Adjustment condition> Horizontal adjustment shall be made using E-12CH Philips pattern and DYNAMIC image mode.</p> <p><Adjustment procedure></p> <ol style="list-style-type: none"> 1) Using WID data, reduce the horizontal amplitude until a part of it is dropped out. 2) Using WID data, adjust the horizontal amplitude so that horizontal raster inevitably contacts with CPT mask. 3) Using the following (Note 1) horizontal screen positional switch, adjust the horizontal raster position to the center position. 4) Using the horizontal amplitude (WID) and horizontal phase (HPOS), adjust the horizontal amplitude so that the right and left flags are just blinded.  <p>The adjustment shall be made so that the right and left flags are just blinded.</p> <ol style="list-style-type: none"> 5) Using PARA, TRAP, CNR and CPAR (or TCNR, BCNR or CSAW if necessary), adjust the screen distortion. 6) If necessary, make the horizontal amplitude adjustment again.

Horizontal adjustment

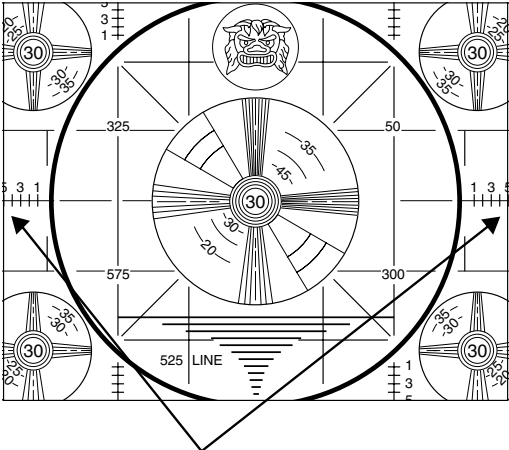
	ADJUSTING ITEMS AND POINTS	ADJUSTMENT PROCEDURE
Horizontal	<p>For NTSC WIDE Horizontal phase (NHPO) Horizontal amplitude (NWID) Side pin distortion (NPAR) Trapezoidal distortion (NTRA) Corner distortion (NCNR) CENT distortion (NCPAR) Parallelogrammatic distortion (NCSAW) Upper corner distortion</p>	<p>* NTSC adjustment shall be made after PAL adjustment.</p> <ol style="list-style-type: none"> 1) With domestic 13ch, WIDE mode and DYNAMIC, adjust the right and left bars to the fifth center for horizontal phase (NHPO) and horizontal amplitude (NWID).  <p>Right and left bars shall be adjusted to the fifth center.</p> <ol style="list-style-type: none"> 2) With domestic 11ch, NPAR, NTRA, NCNR and NCPAR (or NTCNR, NBCNR or NCSAW if necessary), adjust the screen distortion. 3) If necessary, make horizontal amplitude adjustment again.

Vertical adjustment

	ADJUSTING ITEMS AND POINTS	ADJUSTMENT PROCEDURE
Vertical	For PAL WIDE Vertical amplitude (HIT) Vertical screen position (TCNR) Vertical linearity (VLIN)	1) With E-12ch, WIDE mode, DYNAMIC and 100 Hz, adjust the vertical screen position (VPOS) and amplitude (HIT) as shown in the following figure: <div style="text-align: center;"> </div> 2) With vertical linearity (VLIN), control the upper and lower balances to be optimal.
	For NTSC WIDE Vertical amplitude (NHIT) Vertical screen position (NVPO)	* NTSC adjustment shall be made after the PAL adjustment. With domestic 13ch, WIDE mode and DYNAMIC, adjust the vertical screen position (NVPO) and amplitude (NHIT) as shown in the following figure: <div style="text-align: center;"> </div>

Geomagnetic compensation (chassis adjustment)

	ADJUSTING ITEMS AND POINTS	ADJUSTMENT PROCEDURE
1	Output voltage control (GMF)	Conditions: User control for geomagnetic compensation: 0 Geomagnetic compensation coil: Unconnected Perform voltage measurement at both ends of RJ06 and adjust the voltage to the following adjustable value with GMF of data adjustment mode: $0 \pm 1V$

CIRCUIT CHECK

HIGH VOLTAGE CHECK

CAUTION: There is no HIGH VOLTAGE ADJUSTMENT on this chassis. Checking should be done following the steps below.

1. Connect an accurate high voltage meter to the second anode of the picture tube.
2. Turn on the receiver. Set the BRIGHTNESS and CONTRAST controls to minimum (zero beam current).
3. High voltage must be measured below (B) kV.

Refer to table-1 for high voltage (B).
(See SETTING & ADJUSTING DATA on page 15)

4. Vary the BRIGHTNESS control to both extremes to be sure the high voltage does not exceed the limit under any conditions.

CHAPTER 2 SPECIFIC INFORMATIONS

SETTING & ADJUSTING DATA

【 SAFETY INSTRUCTIONS 】

		29"
HIGH VOLTAGE AT ZERO BEAM:	(A)	30.5 kV
MAX HIGH VOLTAGE:	(B)	34.0 kV
AC VOLTAGE	(C)	220~240 V

Table-1

【 SERVICE MODE 】

ADJUSTING ITEMS AND DATAS IN THE SERVICE MODE:

Item	Name of adjustment	Preset	Data	Item	Name of adjustment	Preset	Data
RCUT	R CUTOFF	20H	←	WID	PICTURE WIDTH	50H	5CH
GCUT	G CUTOFF	20H	←	PARA	E-W PARABOLA	1BH	31H
BCUT	B CUTOFF	20H	←	CNR	E-W CORNER	11H	←
GDRV	G DRIVE	40H	←	TRAP	TRAPEZIUM	2FH	4CH
BDRV	B DRIVE	40H	←	CPAR	CENT PARABOLA	07H	←
BRTC	BRIGHTNESS CENTER	C0H	←	TCNR	EW TOP CORNER	0AH	17H
BRTR	BRIGHTNESS RGB	3FH	←	BCNR	EW BOTTOM CORNER	11H	15H
BRTO	BRIGHTNESS OSD	00H	←	CSAW	CENTER SAW	09H	07H
CNTC	CONTRAST CENTER	3FH	←	NHPO	NTSC H-POSITION	03H	←
SCNT	SUB CONTRAST (TV)	08H	←	SCNT	NTSC V-POSITION	04H	98H
SCNV	SUB CONTRAST (VIDEO)	0AH	←	NHIT	NTSC HIGHT	00H	37H
CNTR	CONTRAST RGB	63H	←	NVLI	NTSC V-LINEARITY	00H	0DH
CNTO	CONTRAST OSD	03H	←	NVPS	NTSC V-SHIFT	3EH	←
COLC	COLOR CEN NTSC	57H	←	NWID	NTSC PICTURE WIDTH	03H	52H
COLP	COLOR CEN PAL	57H	←	NPAR	NTSC E-W PARABOLA	01H	29H
COLS	COLOR CEN SECAM	49H	←	NCNR	NTSC E-W CORNER	00H	←
TNTCN	TINT CENTER NTSC	47H	←	NTRA	NTSC TRAPEZIUM	00H	4CH
TNTCP	TINT CENTER PAL	3FH	←	NCPAR	NTSC CENT PARABOLA	00H	08H
HPOS	576i 100Hz	3AH	41H	NTCNR	NTSC TOP CORNER	00H	15H
VPOS	V-POSITION	83H	94H	NBCNR	NTSC BOTTOM CORNER	00H	13H
HIT	HEIGHT	6BH	41H	NCSAW	NTSC CENTER SAW	FFH	07H
VLIN	V-LINEARITY	0FH	0CH	GMF	Geomagnetic	00H	04H
VPS	V-SHIFT	3EH	←				

Table-2

【 DESIGN MODE 】

ADJUSTING ITEMS AND DATAS IN THE DESIGN MODE:

Item	Name of adjustment	Reset
OPT0	OPTION 0	07H
OPT1	OPTION 1	10H
OPT2	OPTION 2	03H

Table-3

NAMES AND FUNCTIONS OF CONTROLS

TV Front and Remote control

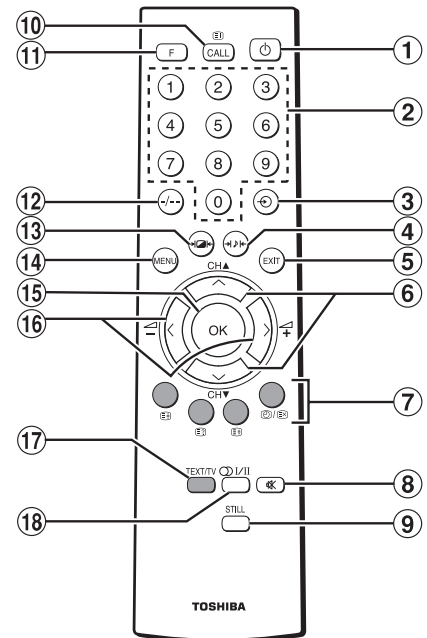
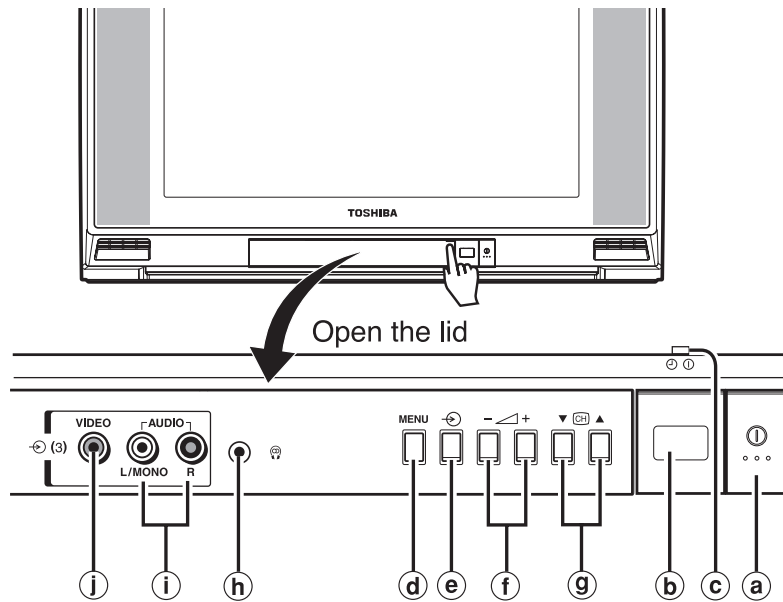

TV		Remote Control	
a	①	①	⏻ Power on/standby
b		②	0~9 Number buttons
c	①	③	⏪ Input source selection
	⏻	④	→ ← Sound selectable mode
d	MENU	⑤	EXIT Press to turn off the on-screen menu.
e	⏪	⑥	CH ▲/▼ Channel up/down, Menu item selection
f	- +	⑦	Teletext colored buttons Red/Green/Yellow/Blue
g	▼ ▲		Teletext functions
h	🎧		Activates only while pressing F button.
i	AUDIO		⏪ - To hold a wanted page
j	VIDEO		⏪ - To reveal concealed text
			⏪ - To enlarge teletext display size
			⏪/⏩ - Time display, To select a page while viewing a normal picture
		⑧	🔇 Sound Mute, press again or ▲/▼ to restore the sound.
		⑨	STILL Picture STILL
		⑩	CALL/☐ On-screen on/off, Teletext initial/index
		⑪	F Function button, press together with teletext function button to activate the selected function.
		⑫	0-9 Digit selection
		⑬	→ ← Picture selectable mode
		⑭	MENU Turn on menu display
		⑮	OK Press to confirm selection.
		⑯	▲/▼ Volume down/up, </> Menu selection or item adjust
		⑰	TEXT/TV Teletext/TV selection
		⑱	⏪/⏩ Stereo/bilingual selection

Note: The shaded button is not available for 29CZ8URS. If you press the button, "MODE NOT AVAILABLE" will appear on the screen.

PROGRAMMING CHANNEL MEMORY

Preset the channels automatically (ASM function)

Use remote control for this operation. The buttons on the TV with similar name may also be use.

- 1 Select the starting position for channel to be preset. Press the Number buttons (-/., 0~9) or CH ▲/▼.



- 2 Set the correct broadcast system for your region. Press **MENU** and then </> to highlight the “**SET UP**” icon.

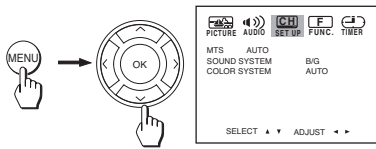

Press V to scroll down the menu (second page) to confirm “COLOR SYSTEM” is set to “AUTO” and “SOUND SYSTEM” is set to proper system. If not, press ^ / v to select “COLOR SYSTEM” or “SOUND SYSTEM” and press </> to set each proper system.

- 3 Press ^ / v to select “ASM”, then press **OK** to start the search. When the TV screen returns to the start position, the procedure is complete.

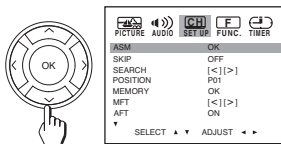

To use the SEARCH function

- 1 Press **MENU** and then </> to highlight the “**SET UP**” icon.

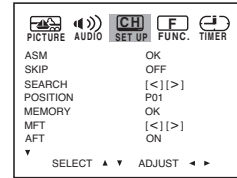

- 2 Press ^ / v to select “SEARCH”. Press </> to start searching. Pressing “<” searches for channels at lower frequencies while pressing “>” searches for channels at higher frequencies. While searching, pressing the opposite direction button, > and < respectively, will cancel SEARCH function.

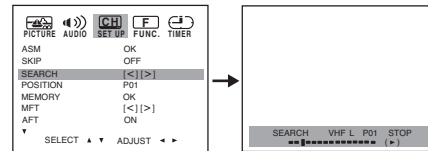

Repeat this process until you can get the desired channel.

- 3 When the desired channel is shown, press v to select “POSITION”. Press </> repeatedly until the position number to be preset is shown.

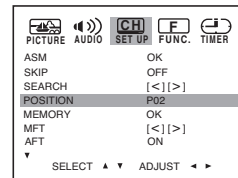

- 4 Press v to select “MEMORY”, then press **OK** to memorize the channel at the current position.

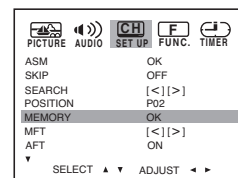

- 5 When you program other channels, repeat steps 2 to 4.

To skip a position number

After presetting the channels, you may skip unnecessary position numbers so that only the channels you want to watch are selected using **CH ▲/▼**.

- 1 First, select the position number to be skipped with **CH ▲/▼** or digit selection and number buttons (-/--, 0~9).
- 2 Highlight the “ SET UP” icon and press **▲ / ▼** to select “SKIP”.

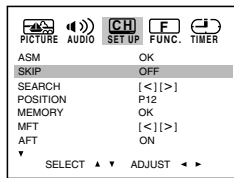

- 3 Press **< / >** to set “SKIP” to “ON”. This completes the setting for skipping the selected position number.

Notes

- When “SKIP” is set to “ON” for the selected position number, a “* ” mark appears to the left of the position number.

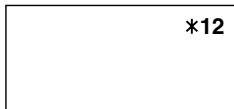

The position number will then be skipped when you select the position with the **CH ▲/▼** buttons.

- If you want to restore a skipped position number, select it using the -/-- and 0~9 buttons then switch the “SKIP” setting to “OFF”.

Manual fine tuning (MFT)

The adjustments below are not necessary under normal conditions. However, under some reception conditions, fine tuning may be necessary to improve the picture quality. In such cases, adjust the manual fine tuning (MFT).

- 1 Select the position number where the channel you want to fine-tune with **CH ▲/▼** or digit selection and number buttons (-/--, 0~9).
- 2 Press **MENU** and then **< / >** to highlight the “ SET UP” icon.
- 3 Press **▲ / ▼** to select “MFT”. Press **< / >** to start fine tuning. Press **< / >** repeatedly until the best possible picture and sound are obtained.

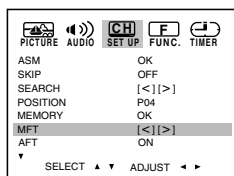

Auto fine tuning (AFT)

If the signal frequency is unstable due to environmental conditions, use auto fine tuning.

- 1 Select the position number where the channel you want to fine-tune with **CH ▲/▼** or the digit selection and number buttons (-/--, 0~9).

Note

When the position is set to “AFT OFF” status, the “” mark appears to the left of the position number.



When the channel is set to “AFT ON” status, the position number is displayed without the “” mark.

- 2 Press **MENU** then **< / >** to highlight the “ SET UP” icon.
- 3 Press **▲ / ▼** to select “AFT”. Press **< / >** to select the “ON” indication.

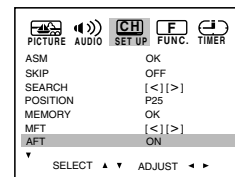

Notes

- When you operate MFT, AFT is switched “OFF” automatically. If you switch on AFT after fine tuning with MFT, MFT may be canceled.
- AFT may be set independently for each position.

CHASSIS AND CABINET REPLACEMENT PARTS LIST

WARNING: BEFORE SERVICING THIS CHASSIS, READ THE “X-RAY RADIATION PRECAUTION”, “SAFETY PRECAUTION” AND “PRODUCT SAFETY NOTICE” ON PAGE 3 OF THIS MANUAL.

CAUTION: The international hazard symbols “⚠” in the schematic diagram and the parts list designate components which have special characteristics important for safety and should be replaced only with types identical to those in the original circuit or specified in the parts list. The mounting position of replacements is to be identical with originals. Before replacing any of these components, read carefully the PRODUCT SAFETY NOTICE. Do not degrade the safety of the receiver through improper servicing.

NOTICE:

- The part number must be used when ordering parts, in order to assist in processing, be sure to include the Model number and Description.
- The PC board assembly with * mark is no longer available after the end of the production.

Model: 29CZ8URB/29CZ8URS

Capacitors CD	: Ceramic Disk	PF	: Plastic Film	EL	: Electrolytic	
Resistors CF	: Carbon Film	CC	: Carbon Composition	MF	: Metal Film	
	OMF	: Oxide Metal Film	VR	: Variable Resistor	FR	: Fusible Resistor

(All CD and PF capacitors are ±5%, 50V and all resistors, ±5%, 1/6W unless otherwise noted.)

Location No.	Parts No.	Description
#1: [29CZ8URB]		
#2: [29CZ8URS]		
CAPACITORS		
C101	76206479	ELECTROLYTIC 50V 4.7UF M 7L 3A
C102	76109102	CERAMIC CHIP 50V B 1000PF K
C103	76203101	ELECTROLYTIC 16V 100UF M 7L 3A
C104	76109103	CERAMIC CHIP 50V B 0.01UF K
C302	76764221	ELECTROLYTIC 25V 220UF M
C304	76214471	CERAMIC DISC 500V B 470PF K
C305	76214471	CERAMIC DISC 500V B 470PF K
C306	76667102	ELECTROLYTIC 25V 1000UF M
C308	76503053	PLASTIC FILM 63V 1UF J
C310	76667102	ELECTROLYTIC 25V 1000UF M
C311	76109471	CERAMIC CHIP 50V B 470PF K
C312	76073036	ELECTROLYTIC 16V 33UF M 3A
C313	76669101	ELECTROLYTIC 50V 100UF M
C314	76764221	ELECTROLYTIC 25V 220UF M
C315	76082256	PLASTIC FILM 100V 2200PF J
C333	76082272	PLASTIC FILM 100V 0.047UF J
C366	76082057	PLASTIC FILM 100V 0.22UF J
C401	76591473	PLASTIC FILM 50V 0.047UF J
C403	76679220	ELECTROLYTIC 250V 22UF M 3A
C413	76214392	CERAMIC DISC 500V B 3900PF K
C416	76678330	ELECTROLYTIC 200V 33UF M 3A
C417	76214391	CERAMIC DISC 500V B 390PF K
C418	76764221	ELECTROLYTIC 25V 220UF M
C434	76591104	PLASTIC FILM 50V 0.1UF J
C438	76764102	ELECTROLYTIC 25V 1000UF M
C441	76693472	PLASTIC FILM 100V 4700PF J
C442	76168057	PLASTIC FILM 540)400V 204J 4-20
C443	76503196	PLASTIC FILM 1800VH 5600PF H
C444	76503198	MT PLA T 1800VH 682H CF92T3Q682HA
C445	76829473	PLASTIC FILM 400V 0.047UF J
C446	76503124	PLASTIC FILM 400V 0.068UF J
C447	76679220	ELECTROLYTIC 250V 22UF M 3A
C448	76640908	ELECTROLYTIC 160V 33UF M 3A LI
C449	76214331	CERAMIC DISC 500V B 330PF K
C461	76168056	PLASTIC FILM 540)400V 184J 4-20
C462	76820123	PLASTIC FILM 630V 0.012UF J
C464	76503149	PLASTIC FILM 250V 3.3UF
C465	76214471	CERAMIC DISC 500V B 470PF K
C466	76214471	CERAMIC DISC 500V B 470PF K
C467	76820153	PLASTIC FILM 630V 0.015UF J
C470	76766220	ELECTROLYTIC 50V 22UF M
C472	76503049	PLASTIC FILM 63V 0.47UF J
C473	76206010	ELECTROLYTIC 50V 1.0UF M 7L 3A
C501	76092730	CERAMIC CHIP 16V B 0.1UF K

Location No.	Parts No.	Description
C502	76092730	CERAMIC CHIP 16V B 0.1UF K
C503	76092730	CERAMIC CHIP 16V B 0.1UF K
C504	76792101	ELECTROLYTIC 6.3V 100UF M
C505	76092730	CERAMIC CHIP 16V B 0.1UF K
C506	76206010	ELECTROLYTIC 50V 1.0UF M 7L 3A
C507	76100103	CERAMIC CHIP 50V F 0.01UF Z
C515	76092730	CERAMIC CHIP 16V B 0.1UF K
C520	76092730	CERAMIC CHIP 16V B 0.1UF K
C521	76092730	CERAMIC CHIP 16V B 0.1UF K
C522	76092730	CERAMIC CHIP 16V B 0.1UF K
C523	76092730	CERAMIC CHIP 16V B 0.1UF K
C524	76203101	ELECTROLYTIC 16V 100UF M 7L 3A
C525	76100103	CERAMIC CHIP 50V F 0.01UF Z
C526	76100103	CERAMIC CHIP 50V F 0.01UF Z
C527	76100103	CERAMIC CHIP 50V F 0.01UF Z
C530	76203220	ELECTROLYTIC 16V 22UF M
C531	76092730	CERAMIC CHIP 16V B 0.1UF K
C536	76203101	ELECTROLYTIC 16V 100UF M 7L 3A
C537	76092730	CERAMIC CHIP 16V B 0.1UF K
C560	76203101	ELECTROLYTIC 16V 100UF M 7L 3A
C562	76092730	CERAMIC CHIP 16V B 0.1UF K
C563	76092730	CERAMIC CHIP 16V B 0.1UF K
C564	76092730	CERAMIC CHIP 16V B 0.1UF K
C566	76100103	CERAMIC CHIP 50V F 0.01UF Z
C567	76100103	CERAMIC CHIP 50V F 0.01UF Z
C570	76092730	CERAMIC CHIP 16V B 0.1UF K
C571	76092730	CERAMIC CHIP 16V B 0.1UF K
C572	76092730	CERAMIC CHIP 16V B 0.1UF K
C573	76100103	CERAMIC CHIP 50V F 0.01UF Z
C574	76206478	ELECTROLYTIC 50V 0.47UF M 7L 3A
C575	76206010	ELECTROLYTIC 50V 1.0UF M 7L 3A
C576	76092730	CERAMIC CHIP 16V B 0.1UF K
C579	76206229	ELECTROLYTIC 50V 2.2UF M 7L 3A
C580	76206010	ELECTROLYTIC 50V 1.0UF M 7L 3A
C581	76206229	ELECTROLYTIC 50V 2.2UF M 7L 3A
C583	76100103	CERAMIC CHIP 50V F 0.01UF Z
C586	76092730	CERAMIC CHIP 16V B 0.1UF K
C588	76105471	CERAMIC CHIP 50V CH 470PF J
C624	76206478	ELECTROLYTIC 50V 0.47UF M 7L 3A
C660	76206010	ELECTROLYTIC 50V 1.0UF M 7L 3A
C662	76109102	CERAMIC CHIP 50V B 1000PF K
C663	76206229	ELECTROLYTIC 50V 2.2UF M 7L 3A
C664	76206010	ELECTROLYTIC 50V 1.0UF M 7L 3A
C666	76109102	CERAMIC CHIP 50V B 1000PF K
C667	76206229	ELECTROLYTIC 50V 2.2UF M 7L 3A
C669	76203470	ELECTROLYTIC 16V 47UF M 7L 3A
C671	76763471	ELECTROLYTIC 16V 470UF M
C672	76203470	ELECTROLYTIC 16V 47UF M 7L 3A

Location No.	Parts No.	Description
C681	76765471	ELECTROLYTIC 35V 470UF M
C682	76765102	ELECTROLYTIC 35V 1000UF M
C683	76765471	ELECTROLYTIC 35V 470UF M
C686	76092883	CERAMIC CHIP 50V B 0.1UF K
C687	76092883	CERAMIC CHIP 50V B 0.1UF K
C690	76766470	ELECTROLYTIC 50V 47UF M
C704	76591822	PLASTIC FILM 50V 8200PF J
C705	76232103	CERAMIC DISC 50V F 0.01UF Z
C707	76203470	ELECTROLYTIC 16V 47UF M 7L 3A
C712	76203470	ELECTROLYTIC 16V 47UF M 7L 3A
C713	76709100	ELECTROLYTIC 200V 10UF M
C714	76436101	CERAMIC DISC 50V SL 100PF J
C715	76214472	CERAMIC DISC 500V B 4700PF K
C716	76436101	CERAMIC DISC 50V SL 100PF J
C717	76214472	CERAMIC DISC 500V B 4700PF K
C718	76797470	ELECTROLYTIC 50V 47UF M
C719	76435560	CERAMIC DISC 500V SL 56PF J
C720	76709100	ELECTROLYTIC 200V 10UF M
C721	76797470	ELECTROLYTIC 50V 47UF M
C726	76212102	CERAMIC DISC 50V B 1000PF K
△ C801	76503507	PLASTIC FILM AC275V 0.22UF K
△ C802	76503507	PLASTIC FILM AC275V 0.22UF K
C805	76092281	CERAMIC DISC AC250V E 4700PF
C806	76092281	CERAMIC DISC AC250V E 4700PF
C807	76503049	PLASTIC FILM 63V 0.47UF J
C808	76765101	ELECTROLYTIC 35V 100UF M
C809	76503049	PLASTIC FILM 63V 0.47UF J
C810	76073107	ELECTROLYTIC 400V 820UF
△ C811	76166021	CERA CAP E 250V 102 DE1E3KX102MB4BL01
△ C812	76591104	PLASTIC FILM 50V 0.1UF J
△ C813	76591104	PLASTIC FILM 50V 0.1UF J
△ C814	76203101	ELECTROLYTIC 16V 100UF M 7L 3A
△ C815	76166021	CERA CAP E 250V 102 DE1E3KX102MB4BL01
C816	76203470	ELECTROLYTIC 16V 47UF M 7L 3A
C817	76092339	CERAMIC DISC 2KV 330PF K
C818	76095931	PLASTIC FILM 1250VH 2200PF J
C819	76676220	ELECTROLYTIC 100V 22UF M 3A
C821	76214471	CERAMIC DISC 500V B 470PF K
C822	76763471	ELECTROLYTIC 16V 470UF M
C823	76214471	CERAMIC DISC 500V B 470PF K
C824	76591104	PLASTIC FILM 50V 0.1UF J
C825	76591104	PLASTIC FILM 50V 0.1UF J
C826	76591104	PLASTIC FILM 50V 0.1UF J
C827	76591104	PLASTIC FILM 50V 0.1UF J
C828	76591104	PLASTIC FILM 50V 0.1UF J
C829	76212271	CERAMIC DISC 50V B 270PF K
C830	76591104	PLASTIC FILM 50V 0.1UF J
C832	76591104	PLASTIC FILM 50V 0.1UF J
C833	76206229	ELECTROLYTIC 50V 2.2UF M 7L 3A
C834	76591104	PLASTIC FILM 50V 0.1UF J
C834A	23960136	ADHESIVE SILICONE TSE3843-W
C835	76591104	PLASTIC FILM 50V 0.1UF J
C836	76591104	PLASTIC FILM 50V 0.1UF J
C837	76591104	PLASTIC FILM 50V 0.1UF J
C838	76203101	ELECTROLYTIC 16V 100UF M 7L 3A
C839	76203101	ELECTROLYTIC 16V 100UF M 7L 3A
C841	76766101	ELECTROLYTIC 50V 100UF M
C842	76203100	ELECTORLYTIC 16V 10UF M 7L 3A
C843	76591104	PLASTIC FILM 50V 0.1UF J
C845	76763471	ELECTROLYTIC 16V 470UF M
C884	76086916	ELECTROLYTIC 160V 330UF M 3D
C885	76214471	CERAMIC DISC 500V B 470PF K
C887	76214471	CERAMIC DISC 500V B 470PF K
C889	76766222	ELECTROLYTIC 50V 2200UF M
C891	76764102	ELECTROLYTIC 25V 1000UF M
C893	76092337	CERAMIC DISC 2KV 220PF K
C894	76764102	ELECTROLYTIC 25V 1000UF M
C895	76797471	ELECTROLYTIC 50V 470UF M
C896	76214471	CERAMIC DISC 500V B 470PF K
C898	76591272	PLASTIC FILM 50V 2700PF J
C899	76214471	CERAMIC DISC 500V B 470PF K
C902	76092349	CERAMIC DISC 2KV R 2200PF K
C904	76436471	CERAMIC DISC 50V SL 470PF J
C905	76436391	CERAMIC DISC 50V SL 390PF J
C907	76436681	CERAMIC DISC 50V SL 680PF J
C909	76073120	ELECTROLYTIC 250V 33UF
C910	76206478	ELECTROLYTIC 50V 0.47UF M 7L 3A
C911	76203100	ELECTORLYTIC 16V 10UF M 7L 3A

Location No.	Parts No.	Description
C912	76073044	ELECTROLYTIC 16V 3300UF M 3A
C913	76794102	ELECTROLYTIC 16V 1000UF M
C914	76232103	CERAMIC DISC 50V F 0.01UF Z
C918	76591104	PLASTIC FILM 50V 0.1UF J
C919	76591104	PLASTIC FILM 50V 0.1UF J
C931	76214101	CERAMIC DISC 500V B 100PF K
CA01	76109103	CERAMIC CHIP 50V B 0.01UF K
CA02	76203100	ELECTORLYTIC 16V 10UF M 7L 3A
CA03	76109103	CERAMIC CHIP 50V B 0.01UF K
CA04	76203100	ELECTORLYTIC 16V 10UF M 7L 3A
CA05	76109103	CERAMIC CHIP 50V B 0.01UF K
CA06	76105101	CERAMIC CHIP 50V CH 100PF J
CA07	76105101	CERAMIC CHIP 50V CH 100PF J
CA13	76105270	CERAMIC CHIP 50V CH 27PF J
CA22	76105100	CERAMIC CHIP 50V CH 10PF D
CA23	76105100	CERAMIC CHIP 50V CH 10PF D
CA24	76105100	CERAMIC CHIP 50V CH 10PF D
CA25	76105100	CERAMIC CHIP 50V CH 10PF D
CA28	76105050	CERAMIC CHIP 50V CH 5PF C
CA29	76105050	CERAMIC CHIP 50V CH 5PF C
CA30	76105101	CERAMIC CHIP 50V CH 100PF J
CA31	76109103	CERAMIC CHIP 50V B 0.01UF K
CA32	76203100	ELECTORLYTIC 16V 10UF M 7L 3A
CA33	76109103	CERAMIC CHIP 50V B 0.01UF K
CA34	76105101	CERAMIC CHIP 50V CH 100PF J
CA37	76105101	CERAMIC CHIP 50V CH 100PF J
CA38	76105101	CERAMIC CHIP 50V CH 100PF J
CA52	76763331	ELECTROLYTIC 16V 330UF M
CA53	76105181	CERAMIC CHIP 50V CH 180PF J
CA54	76206010	ELECTROLYTIC 50V 1.0UF M 7L 3A
CA55	76105102	CERAMIC CHIP 25V CH 1000PF J
CA56	76109332	CERAMIC CHIP 50V B 3300PF K
CA57	76092730	CERAMIC CHIP 16V B 0.1UF K
CA59	76092730	CERAMIC CHIP 16V B 0.1UF K
CB01	76203470	ELECTROLYTIC 16V 47UF M 7L 3A
CB20	76212101	CERAMIC DISC 50V B 100PF K
CB21	76212221	CERAMIC DISC 50V B 220PF K
CB22	76591472	PLASTIC FILM 50V 4700PF J
CB23	76591103	PLASTIC FILM 50V 0.01UF J
CB23A	23965241	TAPE CC #12 10MM L30M
CC07	76109102	CERAMIC CHIP 50V B 1000PF K
CC08	76109102	CERAMIC CHIP 50V B 1000PF K
CC09	76109102	CERAMIC CHIP 50V B 1000PF K
CC10	76109102	CERAMIC CHIP 50V B 1000PF K
CC14	76109103	CERAMIC CHIP 50V B 0.01UF K
CC20	76011224	CHIP 1/20W 220K OHM J
CC25	76109102	CERAMIC CHIP 50V B 1000PF K
CC26	76109102	CERAMIC CHIP 50V B 1000PF K
CC32	76109103	CERAMIC CHIP 50V B 0.01UF K
CC33	76109103	CERAMIC CHIP 50V B 0.01UF K
CD01	76203100	ELECTORLYTIC 16V 10UF M 7L 3A
CD02	76203100	ELECTORLYTIC 16V 10UF M 7L 3A
CD03	76109152	CERAMIC CHIP 50V B 1500PF K
CD04	76105471	CERAMIC CHIP 50V CH 470PF J
CD05	76203100	ELECTORLYTIC 16V 10UF M 7L 3A
CD06	76092730	CERAMIC CHIP 16V B 0.1UF K
CD07	76206339	ELECTROLYTIC 50V 3.3UF M 7L 3A
CD08	76203100	ELECTORLYTIC 16V 10UF M 7L 3A
CD09	76085944	ELECTROLYTIC NP 50V 2.2UF M 11L
CD10	76085944	ELECTROLYTIC NP 50V 2.2UF M 11L
CD12	76105560	CERAMIC CHIP 50V CH 56PF J
CD13	76109152	CERAMIC CHIP 50V B 1500PF K
CD14	76105471	CERAMIC CHIP 50V CH 470PF J
CD15	76203100	ELECTORLYTIC 16V 10UF M 7L 3A
CD17	76109152	CERAMIC CHIP 50V B 1500PF K
CD18	76105471	CERAMIC CHIP 50V CH 470PF J
CD19	76105221	CERAMIC CHIP 50V CH 220PF J
CD21	76105220	CERAMIC CHIP 50V CH 22PF J
CD22	76105220	CERAMIC CHIP 50V CH 22PF J
CD23	76092730	CERAMIC CHIP 16V B 0.1UF K
CD24	76206100	ELECTROLYTIC 50V 10UF M
CD26	76105560	CERAMIC CHIP 50V CH 56PF J
CD27	76105560	CERAMIC CHIP 50V CH 56PF J
CD28	76109102	CERAMIC CHIP 50V B 1000PF K
CD29	76109102	CERAMIC CHIP 50V B 1000PF K
CD30	76109102	CERAMIC CHIP 50V B 1000PF K
CD31	76109102	CERAMIC CHIP 50V B 1000PF K
CD32	76109222	CERAMIC CHIP 50V B 2200PF K

Location No.	Parts No.	Description
CD33	76109222	CERAMIC CHIP 50V B 2200PF K
CD34	76092743	CERAMIC CHIP 10V F 0.47UF Z
CD35	76092743	CERAMIC CHIP 10V F 0.47UF Z
CD36	76109103	CERAMIC CHIP 50V B 0.01UF K
CD37	76105010	CERAMIC CHIP 50V CK 1PF C
CD38	76105050	CERAMIC CHIP 50V CH 5PF C
CP01	76092730	CERAMIC CHIP 16V B 0.1UF K
CP02	76092730	CERAMIC CHIP 16V B 0.1UF K
CP03	76092730	CERAMIC CHIP 16V B 0.1UF K
CP04	76092730	CERAMIC CHIP 16V B 0.1UF K
CP05	76092730	CERAMIC CHIP 16V B 0.1UF K
CP06	76092730	CERAMIC CHIP 16V B 0.1UF K
CP07	76092730	CERAMIC CHIP 16V B 0.1UF K
CP08	76203100	ELECTROLYTIC 16V 10UF M 7L 3A
CP09	76092730	CERAMIC CHIP 16V B 0.1UF K
CP10	76792101	ELECTROLYTIC 6.3V 100UF M
CP11	76792101	ELECTROLYTIC 6.3V 100UF M
CP12	76092730	CERAMIC CHIP 16V B 0.1UF K
CP13	76092730	CERAMIC CHIP 16V B 0.1UF K
CP14	76092730	CERAMIC CHIP 16V B 0.1UF K
CP15	76092730	CERAMIC CHIP 16V B 0.1UF K
CP16	76792101	ELECTROLYTIC 6.3V 100UF M
CP17	76792101	ELECTROLYTIC 6.3V 100UF M
CP18	76092730	CERAMIC CHIP 16V B 0.1UF K
CP19	76092730	CERAMIC CHIP 16V B 0.1UF K
CP20	76092730	CERAMIC CHIP 16V B 0.1UF K
CP21	76092730	CERAMIC CHIP 16V B 0.1UF K
CP22	76092730	CERAMIC CHIP 16V B 0.1UF K
CP23	76092730	CERAMIC CHIP 16V B 0.1UF K
CP24	76105050	CERAMIC CHIP 50V CH 5PF C
CP25	76105050	CERAMIC CHIP 50V CH 5PF C
CP26	76092730	CERAMIC CHIP 16V B 0.1UF K
CP28	76092730	CERAMIC CHIP 16V B 0.1UF K
CP29	76092730	CERAMIC CHIP 16V B 0.1UF K
CP30	76092730	CERAMIC CHIP 16V B 0.1UF K
CP31	76792101	ELECTROLYTIC 6.3V 100UF M
CP32	76092730	CERAMIC CHIP 16V B 0.1UF K
CP33	76105101	CERAMIC CHIP 50V CH 100PF J
CP34	76073001	ELECTROLYTIC 6.3V 100UF M 3A
CP35	76092730	CERAMIC CHIP 16V B 0.1UF K
CP36	76073001	ELECTROLYTIC 6.3V 100UF M 3A
CP37	76092730	CERAMIC CHIP 16V B 0.1UF K
CP38	76105101	CERAMIC CHIP 50V CH 100PF J
CP39	76092730	CERAMIC CHIP 16V B 0.1UF K
CP40	76092730	CERAMIC CHIP 16V B 0.1UF K
CP41	76092730	CERAMIC CHIP 16V B 0.1UF K
CP42	76092730	CERAMIC CHIP 16V B 0.1UF K
CP43	76092730	CERAMIC CHIP 16V B 0.1UF K
CP44	76092730	CERAMIC CHIP 16V B 0.1UF K
CP45	76092730	CERAMIC CHIP 16V B 0.1UF K
CP46	76792101	ELECTROLYTIC 6.3V 100UF M
CP47	76092730	CERAMIC CHIP 16V B 0.1UF K
CP48	76792101	ELECTROLYTIC 6.3V 100UF M
CP49	76092730	CERAMIC CHIP 16V B 0.1UF K
CP50	76092730	CERAMIC CHIP 16V B 0.1UF K
CP51	76792101	ELECTROLYTIC 6.3V 100UF M
CP52	76092730	CERAMIC CHIP 16V B 0.1UF K
CP53	76092730	CERAMIC CHIP 16V B 0.1UF K
CP54	76792101	ELECTROLYTIC 6.3V 100UF M
CP55	76092730	CERAMIC CHIP 16V B 0.1UF K
CP56	76665101	ELECTROLYTIC 10V 100UF M
CP57	76092730	CERAMIC CHIP 16V B 0.1UF K
CP58	76792101	ELECTROLYTIC 6.3V 100UF M
CP59	76092730	CERAMIC CHIP 16V B 0.1UF K
CP60	76092730	CERAMIC CHIP 16V B 0.1UF K
CP61	76792101	ELECTROLYTIC 6.3V 100UF M
CP62	76092730	CERAMIC CHIP 16V B 0.1UF K
CP63	76092730	CERAMIC CHIP 16V B 0.1UF K
CP64	76792101	ELECTROLYTIC 6.3V 100UF M
CP65	76092730	CERAMIC CHIP 16V B 0.1UF K
CP66	76762101	ELECTROLYTIC 10V 100UF
CP67	76092730	CERAMIC CHIP 16V B 0.1UF K
CP68	76792101	ELECTROLYTIC 6.3V 100UF M
CP69	76092730	CERAMIC CHIP 16V B 0.1UF K
CP70	76073001	ELECTROLYTIC 6.3V 100UF M 3A
CP71	76092730	CERAMIC CHIP 16V B 0.1UF K
CP72	76092730	CERAMIC CHIP 16V B 0.1UF K
CP73	76073001	ELECTROLYTIC 6.3V 100UF M 3A

Location No.	Parts No.	Description
CP74	76092730	CERAMIC CHIP 16V B 0.1UF K
CP75	76092730	CERAMIC CHIP 16V B 0.1UF K
CP76	76792101	ELECTROLYTIC 6.3V 100UF M
CP77	76092730	CERAMIC CHIP 16V B 0.1UF K
CP78	76762101	ELECTROLYTIC 10V 100UF
CP79	76762471	ELECTROLYTIC 10V 470UF M
CS02	76206010	ELECTROLYTIC 50V 1.0UF M 7L 3A
CS03	76206010	ELECTROLYTIC 50V 1.0UF M 7L 3A
CS04	76206010	ELECTROLYTIC 50V 1.0UF M 7L 3A
CS05	76206010	ELECTROLYTIC 50V 1.0UF M 7L 3A
CS06	76206010	ELECTROLYTIC 50V 1.0UF M 7L 3A
CS07	76206010	ELECTROLYTIC 50V 1.0UF M 7L 3A
CS10	76203100	ELECTROLYTIC 16V 10UF M 7L 3A
CS11	76203100	ELECTROLYTIC 16V 10UF M 7L 3A
CS12	76206010	ELECTROLYTIC 50V 1.0UF M 7L 3A
CS13	76206010	ELECTROLYTIC 50V 1.0UF M 7L 3A
CS15	76109103	CERAMIC CHIP 50V B 0.01UF K
CS29	76203220	ELECTROLYTIC 16V 22UF M
CT01	#1 76092730	CERAMIC CHIP 16V B 0.1UF K
CT02	#1 76092730	CERAMIC CHIP 16V B 0.1UF K
CT03	#1 76092730	CERAMIC CHIP 16V B 0.1UF K
CT04	#1 76792101	ELECTROLYTIC 6.3V 100UF M
CT05	#1 76092730	CERAMIC CHIP 16V B 0.1UF K
CT06	#1 76092730	CERAMIC CHIP 16V B 0.1UF K
CT07	#1 76792101	ELECTROLYTIC 6.3V 100UF M
CT08	#1 76105560	CERAMIC CHIP 50V CH 56PF J
CT09	#1 76105560	CERAMIC CHIP 50V CH 56PF J
CV01	76203101	ELECTROLYTIC 16V 100UF M 7L 3A
CV03	76206478	ELECTROLYTIC 50V 0.47UF M 7L 3A
CV04	76206010	ELECTROLYTIC 50V 1.0UF M 7L 3A
CV05	76203220	ELECTROLYTIC 16V 22UF M
CV06	76591473	PLASTIC FILM 50V 0.047UF J
CV07	76212102	CERAMIC DISC 50V B 1000PF K
CV08	76212102	CERAMIC DISC 50V B 1000PF K
CV11	76109103	CERAMIC CHIP 50V B 0.01UF K
CV19	76092730	CERAMIC CHIP 16V B 0.1UF K
CV20	76092730	CERAMIC CHIP 16V B 0.1UF K
CV22	76092730	CERAMIC CHIP 16V B 0.1UF K
CV33	76109103	CERAMIC CHIP 50V B 0.01UF K
CV34	76793471	ELECTROLYTIC 10V 470UF M
CV36	76763221	ELECTROLYTIC 16V 220UF M
CX02	76503047	PLASTIC FILM 63V 0.33UF J
CX03	76503053	PLASTIC FILM 63V 1UF J
CX05	76092733	CERAMIC CHIP 50V B 0.022UF K
CX06	76105101	CERAMIC CHIP 50V CH 100PF J
CX07	76503049	PLASTIC FILM 63V 0.47UF J
CX08	76109822	CERAMIC CHIP 50V B 8200PF K
CX09	76100103	CERAMIC CHIP 50V F 0.01UF Z
CX10	76591473	PLASTIC FILM 50V 0.047UF J
CX11	76763471	ELECTROLYTIC 16V 470UF M
CX12	76109332	CERAMIC CHIP 50V B 3300PF K
CX15	76503042	PLASTIC FILM 63V 0.12UF J
CX16	76109272	CERAMIC CHIP 50V B 2700PF K
CX17	76206010	ELECTROLYTIC 50V 1.0UF M 7L 3A
CX18	76763471	ELECTROLYTIC 16V 470UF M
CX19	76203100	ELECTROLYTIC 16V 10UF M 7L 3A
CX20	76203220	ELECTROLYTIC 16V 22UF M
CX51	76085958	ELECTROLYTIC NP 50V 1UF M
CX52	76092730	CERAMIC CHIP 16V B 0.1UF K
CX53	76203101	ELECTROLYTIC 16V 100UF M 7L 3A
CX54	76206010	ELECTROLYTIC 50V 1.0UF M 7L 3A
CX55	76092730	CERAMIC CHIP 16V B 0.1UF K
CY01	76100103	CERAMIC CHIP 50V F 0.01UF Z
CY02	76100103	CERAMIC CHIP 50V F 0.01UF Z
CY03	76092730	CERAMIC CHIP 16V B 0.1UF K
CY04	76792101	ELECTROLYTIC 6.3V 100UF M
CY05	76100152	CHIP CERA CK73F 50V 152Z CK73F1H152Z
CY08	76105220	CERAMIC CHIP 50V CH 22PF J
CY09	76100102	CERAMIC CHIP 50V F 1000PF Z
CY10	76105180	CERAMIC CHIP 50V CH 18PF J
CY11	76092730	CERAMIC CHIP 16V B 0.1UF K
CY12	76092730	CERAMIC CHIP 16V B 0.1UF K
CY13	76092730	CERAMIC CHIP 16V B 0.1UF K
CY15	76092730	CERAMIC CHIP 16V B 0.1UF K
CY16	76092730	CERAMIC CHIP 16V B 0.1UF K
CY17	76092730	CERAMIC CHIP 16V B 0.1UF K
CY18	76092730	CERAMIC CHIP 16V B 0.1UF K
CY19	76092730	CERAMIC CHIP 16V B 0.1UF K

Location No.	Parts No.	Description
CY20	76105101	CERAMIC CHIP 50V CH 100PF J
CY21	76105101	CERAMIC CHIP 50V CH 100PF J
CY22	76100103	CERAMIC CHIP 50V F 0.01UF Z
CY23	76100103	CERAMIC CHIP 50V F 0.01UF Z
CY24	76105101	CERAMIC CHIP 50V CH 100PF J
CY25	76105101	CERAMIC CHIP 50V CH 100PF J
CY26	76100103	CERAMIC CHIP 50V F 0.01UF Z
CY27	76100103	CERAMIC CHIP 50V F 0.01UF Z
CY28	76092730	CERAMIC CHIP 16V B 0.1UF K
CY29	76100103	CERAMIC CHIP 50V F 0.01UF Z
CY30	76203470	ELECTROLYTIC 16V 47UF M 7L 3A
CY31	76100103	CERAMIC CHIP 50V F 0.01UF Z
CY32	76092730	CERAMIC CHIP 16V B 0.1UF K
CY33	76100103	CERAMIC CHIP 50V F 0.01UF Z
CY34	76203470	ELECTROLYTIC 16V 47UF M 7L 3A
CY35	76100103	CERAMIC CHIP 50V F 0.01UF Z
CY36	76100103	CERAMIC CHIP 50V F 0.01UF Z
CY37	76092730	CERAMIC CHIP 16V B 0.1UF K
CY38	76203470	ELECTROLYTIC 16V 47UF M 7L 3A
CY39	76100103	CERAMIC CHIP 50V F 0.01UF Z
CY40	76100103	CERAMIC CHIP 50V F 0.01UF Z
CY41	76203470	ELECTROLYTIC 16V 47UF M 7L 3A
CY42	76092730	CERAMIC CHIP 16V B 0.1UF K
CY44	76092743	CERAMIC CHIP 10V F 0.47UF Z
CY45	76092743	CERAMIC CHIP 10V F 0.47UF Z
CY46	76100103	CERAMIC CHIP 50V F 0.01UF Z
CY47	76092743	CERAMIC CHIP 10V F 0.47UF Z
CY48	76092743	CERAMIC CHIP 10V F 0.47UF Z
CY49	76073001	ELECTROLYTIC 6.3V 100UF M 3A
CY50	76092730	CERAMIC CHIP 16V B 0.1UF K
CY51	76105101	CERAMIC CHIP 50V CH 100PF J
CY52	76073001	ELECTROLYTIC 6.3V 100UF M 3A
CY53	76092730	CERAMIC CHIP 16V B 0.1UF K
CY54	76105101	CERAMIC CHIP 50V CH 100PF J
CY58	76203100	ELECTROLYTIC 16V 10UF M 7L 3A
CY59	76092730	CERAMIC CHIP 16V B 0.1UF K
CY60	76105120	CERAMIC CHIP 50V CH 12PF J
CY61	76105150	CERAMIC CHIP 50V CH 15PF J
CY62	76105270	CERAMIC CHIP 50V CH 27PF J
CY63	76203100	ELECTROLYTIC 16V 10UF M 7L 3A
CY64	76092730	CERAMIC CHIP 16V B 0.1UF K
CY65	76105120	CERAMIC CHIP 50V CH 12PF J
CY66	76105150	CERAMIC CHIP 50V CH 15PF J
CY67	76105270	CERAMIC CHIP 50V CH 27PF J
CY68	76203470	ELECTROLYTIC 16V 47UF M 7L 3A
CY69	76092730	CERAMIC CHIP 16V B 0.1UF K
CY70	76105120	CERAMIC CHIP 50V CH 12PF J
CY71	76105150	CERAMIC CHIP 50V CH 15PF J
CY72	76105270	CERAMIC CHIP 50V CH 27PF J
CY73	76100103	CERAMIC CHIP 50V F 0.01UF Z
CY74	76092730	CERAMIC CHIP 16V B 0.1UF K
CY75	76105120	CERAMIC CHIP 50V CH 12PF J
CY76	76105150	CERAMIC CHIP 50V CH 15PF J
CY77	76105270	CERAMIC CHIP 50V CH 27PF J
CY78	76203470	ELECTROLYTIC 16V 47UF M 7L 3A
CY79	76092730	CERAMIC CHIP 16V B 0.1UF K
CY80	76105120	CERAMIC CHIP 50V CH 12PF J
CY81	76105150	CERAMIC CHIP 50V CH 15PF J
CY82	76105270	CERAMIC CHIP 50V CH 27PF J
CY83	76073001	ELECTROLYTIC 6.3V 100UF M 3A
CY84	76092730	CERAMIC CHIP 16V B 0.1UF K
CY85	76792101	ELECTROLYTIC 6.3V 100UF M
CY86	76092730	CERAMIC CHIP 16V B 0.1UF K
CY87	76792101	ELECTROLYTIC 6.3V 100UF M
CY88	76092730	CERAMIC CHIP 16V B 0.1UF K
RESISTORS		
G472	76381131	OXIDE METAL FILM 1/2W 130 OHM J
GJ01	76000445	CHIP JUMPER 1608TYPE
GR470	76339518	OXIDE METAL FILM 2W 0.51 OHM J
GR48	76000445	CHIP JUMPER 1608TYPE
GR50	76000445	CHIP JUMPER 1608TYPE
GR51	76000445	CHIP JUMPER 1608TYPE
GRI01	76000445	CHIP JUMPER 1608TYPE
GRI02	76000445	CHIP JUMPER 1608TYPE
GRI04	76000445	CHIP JUMPER 1608TYPE
JR001	76000824	CHIP JUMPER 2125TYPE
JR002	76000576	CHIP JUMPER 3216TYPE

Location No.	Parts No.	Description
JR003	76000576	CHIP JUMPER 3216TYPE
JR004	76000824	CHIP JUMPER 2125TYPE
JR005	76000824	CHIP JUMPER 2125TYPE
JR006	76000445	CHIP JUMPER 1608TYPE
JR007	76000576	CHIP JUMPER 3216TYPE
JR008	76000824	CHIP JUMPER 2125TYPE
JR009	76000445	CHIP JUMPER 1608TYPE
JR010	76000445	CHIP JUMPER 1608TYPE
JR011	76000576	CHIP JUMPER 3216TYPE
JR012	76000824	CHIP JUMPER 2125TYPE
JR013	76000576	CHIP JUMPER 3216TYPE
JR014	76000824	CHIP JUMPER 2125TYPE
JR015	76000824	CHIP JUMPER 2125TYPE
JR017	76000824	CHIP JUMPER 2125TYPE
JR018	76000824	CHIP JUMPER 2125TYPE
JR019	76000824	CHIP JUMPER 2125TYPE
JR020	76000576	CHIP JUMPER 3216TYPE
JR021	76000824	CHIP JUMPER 2125TYPE
JR022	76000576	CHIP JUMPER 3216TYPE
JR023	76000576	CHIP JUMPER 3216TYPE
JR024	76000576	CHIP JUMPER 3216TYPE
JR025	76000445	CHIP JUMPER 1608TYPE
JR026	76000824	CHIP JUMPER 2125TYPE
JR027	76000576	CHIP JUMPER 3216TYPE
JR028	76000576	CHIP JUMPER 3216TYPE
JR029	76000576	CHIP JUMPER 3216TYPE
JR030	76000576	CHIP JUMPER 3216TYPE
JR031	76000824	CHIP JUMPER 2125TYPE
JR032	76000576	CHIP JUMPER 3216TYPE
JR033	76000576	CHIP JUMPER 3216TYPE
JR034	76000576	CHIP JUMPER 3216TYPE
JR035	76000576	CHIP JUMPER 3216TYPE
JR036	76000824	CHIP JUMPER 2125TYPE
JR037	76000445	CHIP JUMPER 1608TYPE
JR038	76000576	CHIP JUMPER 3216TYPE
JR039	76000824	CHIP JUMPER 2125TYPE
JR040	76000576	CHIP JUMPER 3216TYPE
JR041	76000824	CHIP JUMPER 2125TYPE
JR042	76000824	CHIP JUMPER 2125TYPE
JR043	76000824	CHIP JUMPER 2125TYPE
JR044	76000824	CHIP JUMPER 2125TYPE
JR045	76000576	CHIP JUMPER 3216TYPE
JR046	76000576	CHIP JUMPER 3216TYPE
JR047	76000576	CHIP JUMPER 3216TYPE
JR048	76000576	CHIP JUMPER 3216TYPE
JR049	76000576	CHIP JUMPER 3216TYPE
JR050	76000576	CHIP JUMPER 3216TYPE
JR051	76000576	CHIP JUMPER 3216TYPE
JR052	76000576	CHIP JUMPER 3216TYPE
JR053	76000824	CHIP JUMPER 2125TYPE
JR054	76000576	CHIP JUMPER 3216TYPE
JR055	76000445	CHIP JUMPER 1608TYPE
JR056	76000576	CHIP JUMPER 3216TYPE
JR060	76000576	CHIP JUMPER 3216TYPE
JR061	76000576	CHIP JUMPER 3216TYPE
JR062	76000576	CHIP JUMPER 3216TYPE
R156	76382183	OXIDE METAL FILM 1W 18K OHM J
R217	76367472	CARBON FILM 1/6W 4.7K OHM G
R228	76367392	CARBON FILM 1/6W 3.9K OHM G
R301	76011223	CHIP 1/20W 22K OHM J
R302	76011102	CHIP 1/20W 1K OHM J
R303	76382391	OXIDE METAL FILM 1W 390 OHM J
R304	76321129	OXIDE METAL FILM 1/2W 1.2 OHM J
R305	76322109	OXIDE METAL FILM 1W 1 OHM J
R306	76011102	CHIP 1/20W 1K OHM J
R308	76339229	OXIDE METAL FILM 2W 2.2 OHM J
R316	76011102	CHIP 1/20W 1K OHM J
R328	76339229	OXIDE METAL FILM 2W 2.2 OHM J
R336	76383331	OXIDE METAL FILM 2W 330 OHM J
R337	76000633	METAL FILM 1/4W 10K OHM F
R402	76011682	CHIP 1/20W 6.8K OHM J
R403	76366682	CARBON FILM 1/6W 6.8K OHM J
R404	76366101	CARBON FILM 1/6W 100 OHM J
R411	76366101	CARBON FILM 1/6W 100 OHM J
R4111	76019259	FUSIBLE 1/4W 27 OHM G
R415	76383271	OXIDE METAL FILM 2W 270 OHM J
R416	76554820	OXIDE FILM 2W 82 J
R417	76323228	OXIDE METAL FILM 2W 0.22 OHM J

Location No.	Parts No.	Description
R429	76552150	OXIDE METAL FILM 1/2W 15 OHM J
R430	76366103	CARBON FILM 1/6W 10K OHM J
R441	76554181	OXIDE METAL FILM 2W 180 OHM J
R447	76382472	OXIDE METAL FILM 1W 4.7K OHM J
R448	76338398	OXIDE METAL FILM 1W 0.39 OHM J
R460	76003898	METAL FILM 1/4W 3.3K OHM J
R461	76366331	CARBON FILM 1/6W 330 OHM J
R462	76000445	CHIP JUMPER 1608TYPE
R466	76383220	OXIDE METAL FILM 2W 22 OHM J
R467	76383220	OXIDE METAL FILM 2W 22 OHM J
R469	76366104	CARBON FILM 1/6W 100K OHM J
R471	76531271	FUSIBLE 1/2W 270 OHM J
R472	76011102	CHIP 1/20W 1K OHM J
R473	76011393	CHIP 1/20W 39K OHM J
R474	76000221	METAL FILM 1/4W 20K OHM F
R477	76011392	CHIP 1/20W 3.9K OHM J
R501	76011101	CHIP 1/20W 100 OHM J
R502	76011101	CHIP 1/20W 100 OHM J
R504	76381221	OXIDE METAL FILM 1/2W 220 OHM J
R505	76011332	CHIP 1/20W 3.3K OHM J
R506	76011471	CHIP 1/20W 470 OHM J
R510	76011101	CHIP 1/20W 100 OHM J
R518	76011101	CHIP 1/20W 100 OHM J
R519	76011101	CHIP 1/20W 100 OHM J
R520	23103828	INDUCTOR BEAD TEM2121M
R521	23103828	INDUCTOR BEAD TEM2121M
R522	23103828	INDUCTOR BEAD TEM2121M
R526	76011101	CHIP 1/20W 100 OHM J
R527	76011222	CHIP 1/20W 2.2K OHM J
R528	76011104	CHIP 1/20W 100K OHM J
R531	76011102	CHIP 1/20W 1K OHM J
R532	76011102	CHIP 1/20W 1K OHM J
R533	76011102	CHIP 1/20W 1K OHM J
R534	#2 76011101	CHIP 1/20W 100 OHM J
R535	#2 76000445	CHIP JUMPER 1608TYPE
R536	#2 76000445	CHIP JUMPER 1608TYPE
R537	#2 76000445	CHIP JUMPER 1608TYPE
R540	76011101	CHIP 1/20W 100 OHM J
R541	76011101	CHIP 1/20W 100 OHM J
R542	76011101	CHIP 1/20W 100 OHM J
R543	76011101	CHIP 1/20W 100 OHM J
R544	76011332	CHIP 1/20W 3.3K OHM J
R565	76011101	CHIP 1/20W 100 OHM J
R566	76011101	CHIP 1/20W 100 OHM J
R567	76011101	CHIP 1/20W 100 OHM J
R568	76011561	CHIP 1/20W 560 OHM J
R569	76011561	CHIP 1/20W 560 OHM J
R570	76011101	CHIP 1/20W 100 OHM J
R571	#1 76011101	CHIP 1/20W 100 OHM J
R573	76011224	CHIP 1/20W 220K OHM J
R575	76011102	CHIP 1/20W 1K OHM J
R583	76011273	CHIP 1/20W 27K OHM J
R584	76011561	CHIP 1/20W 560 OHM J
R587	76011222	CHIP 1/20W 2.2K OHM J
R588	76011472	CHIP 1/20W 4.7K OHM J
R589	76011332	CHIP 1/20W 3.3K OHM J
R590	76011101	CHIP 1/20W 100 OHM J
R591	76011102	CHIP 1/20W 1K OHM J
R592	76011471	CHIP 1/20W 470 OHM J
R596	76011102	CHIP 1/20W 1K OHM J
R597	76011102	CHIP 1/20W 1K OHM J
R598	76011102	CHIP 1/20W 1K OHM J
R620	76011103	CHIP 1/20W 10K OHM J
R621	76011822	CHIP 1/20W 8.2K OHM J
R623	76366103	CARBON FILM 1/6W 10K OHM J
R624	76011104	CHIP 1/20W 100K OHM J
R660	76011222	CHIP 1/20W 2.2K OHM J
R662	76011102	CHIP 1/20W 1K OHM J
R664	76011222	CHIP 1/20W 2.2K OHM J
R666	76011102	CHIP 1/20W 1K OHM J
R671	76011103	CHIP 1/20W 10K OHM J
R672	76011103	CHIP 1/20W 10K OHM J
R673	76011103	CHIP 1/20W 10K OHM J
R674	76011103	CHIP 1/20W 10K OHM J
R675	76011104	CHIP 1/20W 100K OHM J
R686	76011229	CHIP 1/16W 2.2 OHM J
R687	76011229	CHIP 1/16W 2.2 OHM J
R688	76323339	OXIDE METAL FILM 2W 3.3 OHM J

Location No.	Parts No.	Description
R702	76552221	OXIDE METAL FILM 1/2W 220 OHM J
R709	76366563	CARBON FILM 1/6W 56K OHM J
R713	76366393	CARBON FILM 1/6W 39K OHM J
R715	76366273	CARBON FILM 1/6W 27K OHM J
R716	76366273	CARBON FILM 1/6W 27K OHM J
R717	76366333	CARBON FILM 1/6W 33K OHM J
R718	76366222	CARBON FILM 1/6W 2.2K OHM J
R719	76366101	CARBON FILM 1/6W 100 OHM J
R720	76366102	CARBON FILM 1/6W 1K OHM J
R721	76366101	CARBON FILM 1/6W 100 OHM J
R722	76552471	OXIDE METAL FILM 1/2W 470 OHM J
R723	76366101	CARBON FILM 1/6W 100 OHM J
R724	76366151	CARBON FILM 1/6W 150 OHM J
R725	76366182	CARBON FILM 1/6W 1.8K OHM J
R730	76552100	OXIDE METAL FILM 1/2W 10 OHM J
R731	76552331	OXIDE METAL FILM 1/2W 330 OHM J
R732	76366330	CARBON FILM 1/6W 33 OHM J
R733	76366683	CARBON FILM 1/6W 68K OHM J
R734	76366330	CARBON FILM 1/6W 33 OHM J
R735	76366683	CARBON FILM 1/6W 68K OHM J
R736	76553470	OXIDE METAL FILM 1W 47 OHM J
R737	76366681	CARBON FILM 1/6W 680 OHM J
R738	76366102	CARBON FILM 1/6W 1K OHM J
R739	76366681	CARBON FILM 1/6W 680 OHM J
R740	76553470	OXIDE METAL FILM 1W 47 OHM J
R741	76322229	OXIDE METAL FILM 1W 2.2 OHM J
R742	76322229	OXIDE METAL FILM 1W 2.2 OHM J
R743	76554181	OXIDE METAL FILM 2W 180 OHM J
R744	76366122	CARBON FILM 1/6W 1.2K OHM J
R745	76366122	CARBON FILM 1/6W 1.2K OHM J
△ R801	76017010	METAL GLAZE 1/2W PRC92M02M20J
R803	76553683	OXIDE METAL FILM 1W 68K OHM J
R805	76552101	OXIDE METAL FILM 1/2W 100 OHM J
R806	76381223	OXIDE METAL FILM 1/2W 22K OHM J
△ R807	76366104	CARBON FILM 1/6W 100K OHM J
R808	76079005	THERMISTOR PTC DGC3D4R5M27
R811	76366225	CARBON FILM 1/6W 2.2M OHM J
R814	76366152	CARBON FILM 1/6W 1.5K OHM J
R815	76552102	OXIDE METAL FILM 1/2W 1K OHM J
R816	76019460	METAL PLATE 2W 0.1 OHM J
R817	76321338	OXIDE METAL FILM 1/2W 0.33 OHM J
R819	76310829	OXIDE METAL FILM 1/2W 8.2 OHM J
R820	76366101	CARBON FILM 1/6W 100 OHM J
R822	76552103	OXIDE METAL FILM 1/2W 10K OHM J
R823	76381123	OXIDE METAL FILM 1/2W 12K OHM J
R824	76569689	CERAMIC COVERED 10W 6.8 OHM J
R827	76011472	CHIP 1/20W 4.7K OHM J
R828	76011222	CHIP 1/20W 2.2K OHM J
R830	76366222	CARBON FILM 1/6W 2.2K OHM J
R841	76531120	FUSIBLE 1/2W 12 OHM J
R842	76552392	OXIDE METAL FILM 1/2W 3.9K OHM J
R844	76011332	CHIP 1/20W 3.3K OHM J
R845	76011472	CHIP 1/20W 4.7K OHM J
R847	76011472	CHIP 1/20W 4.7K OHM J
R880	76552471	OXIDE METAL FILM 1/2W 470 OHM J
R881	76552561	OXIDE METAL FILM 1/2W 560 OHM J
△ R899	76017012	METAL GLAZE 1/2W PRC92M08M20J
R901	76946561	CARBON COMPOSITION 1/2W 560 OHM K
R902	76946561	CARBON COMPOSITION 1/2W 560 OHM K
R903	76946561	CARBON COMPOSITION 1/2W 560 OHM K
R904	76366472	CARBON FILM 1/6W 4.7K OHM J
R905	76366150	CARBON FILM 1/6W 15 OHM J
R912	76366102	CARBON FILM 1/6W 1K OHM J
R914	76366151	CARBON FILM 1/6W 150 OHM J
R915	76366470	CARBON FILM 1/6W 47 OHM J
R916	76366150	CARBON FILM 1/6W 15 OHM J
R917	76366331	CARBON FILM 1/6W 330 OHM J
R918	76366330	CARBON FILM 1/6W 33 OHM J
R919	76366102	CARBON FILM 1/6W 1K OHM J
R920	76000880	FUSIBLE 1W 5.1 OHM J
R921	76366151	CARBON FILM 1/6W 150 OHM J
R922	76366470	CARBON FILM 1/6W 47 OHM J
R924	76366330	CARBON FILM 1/6W 33 OHM J
R925	76366331	CARBON FILM 1/6W 330 OHM J
R926	76366102	CARBON FILM 1/6W 1K OHM J
R928	76366151	CARBON FILM 1/6W 150 OHM J
R929	76366470	CARBON FILM 1/6W 47 OHM J
R930	76366390	CARBON FILM 1/6W 39 OHM J

Location No.	Parts No.	Description
R932	76366332	CARBON FILM 1/6W 3.3K OHM J
R934	76366391	CARBON FILM 1/6W 390 OHM J
R935	76366102	CARBON FILM 1/6W 1K OHM J
R937	76366331	CARBON FILM 1/6W 330 OHM J
R939	76366100	CARBON FILM 1/6W 10 OHM J
R942	76366392	CARBON FILM 1/6W 3.9K OHM J
R943	76366392	CARBON FILM 1/6W 3.9K OHM J
R944	76366392	CARBON FILM 1/6W 3.9K OHM J
R945	76366150	CARBON FILM 1/6W 15 OHM J
R946	76366150	CARBON FILM 1/6W 15 OHM J
R952	76366622	CARBON FILM 1/6W 6.2K OHM J
R953	76366622	CARBON FILM 1/6W 6.2K OHM J
R954	76366622	CARBON FILM 1/6W 6.2K OHM J
R960	76383153	OXIDE METAL FILM 2W 15K OHM J
R961	76383153	OXIDE METAL FILM 2W 15K OHM J
R962	76383153	OXIDE METAL FILM 2W 15K OHM J
R963	76383153	OXIDE METAL FILM 2W 15K OHM J
R964	76383153	OXIDE METAL FILM 2W 15K OHM J
R965	76383153	OXIDE METAL FILM 2W 15K OHM J
R977	76366561	CARBON FILM 1/6W 560 OHM J
R978	76383153	OXIDE METAL FILM 2W 15K OHM J
R979	76383153	OXIDE METAL FILM 2W 15K OHM J
R980	76366471	CARBON FILM 1/6W 470 OHM J
R981	76366471	CARBON FILM 1/6W 470 OHM J
R992	76366150	CARBON FILM 1/6W 15 OHM J
R993	76383153	OXIDE METAL FILM 2W 15K OHM J
R994	76383153	OXIDE METAL FILM 2W 15K OHM J
R995	76383153	OXIDE METAL FILM 2W 15K OHM J
R996	76383153	OXIDE METAL FILM 2W 15K OHM J
RA01	76366101	CARBON FILM 1/6W 100 OHM J
RA02	76011101	CHIP 1/20W 100 OHM J
RA03	76011102	CHIP 1/20W 1K OHM J
RA04	76366101	CARBON FILM 1/6W 100 OHM J
RA05	76366101	CARBON FILM 1/6W 100 OHM J
RA07	76011101	CHIP 1/20W 100 OHM J
RA08	76011472	CHIP 1/20W 4.7K OHM J
RA09	76011472	CHIP 1/20W 4.7K OHM J
RA13	76011273	CHIP 1/20W 27K OHM J
RA14	76011102	CHIP 1/20W 1K OHM J
RA17	76011101	CHIP 1/20W 100 OHM J
RA18	76011102	CHIP 1/20W 1K OHM J
RA21	76011511	CHIP 1/20W 510 OHM J
RA22	76011682	CHIP 1/20W 6.8K OHM J
RA23	76011682	CHIP 1/20W 6.8K OHM J
RA24	76011682	CHIP 1/20W 6.8K OHM J
RA25	76011221	CHIP 1/20W 220 OHM J
RA26	76366102	CARBON FILM 1/6W 1K OHM J
RA27	76366102	CARBON FILM 1/6W 1K OHM J
RA30	76011101	CHIP 1/20W 100 OHM J
RA31	76011101	CHIP 1/20W 100 OHM J
RA33	76011561	CHIP 1/20W 560 OHM J
RA34	76011101	CHIP 1/20W 100 OHM J
RA35	76011101	CHIP 1/20W 100 OHM J
RA37	76011101	CHIP 1/20W 100 OHM J
RA38	76011101	CHIP 1/20W 100 OHM J
RA39	76011101	CHIP 1/20W 100 OHM J
RA40	76011472	CHIP 1/20W 4.7K OHM J
RA41	76011472	CHIP 1/20W 4.7K OHM J
RA43	76366103	CARBON FILM 1/6W 10K OHM J
RA46	76366470	CARBON FILM 1/6W 47 OHM J
RA47	76011472	CHIP 1/20W 4.7K OHM J
RA48	76011472	CHIP 1/20W 4.7K OHM J
RA49	76011563	CHIP 1/20W 56K OHM J
RA51	76011122	CHIP 1/20W 1.2K OHM J
RA52	76011122	CHIP 1/20W 1.2K OHM J
RA53	76011122	CHIP 1/20W 1.2K OHM J
RA54	76366472	CARBON FILM 1/6W 4.7K OHM J
RA55	76366472	CARBON FILM 1/6W 4.7K OHM J
RA56	76011472	CHIP 1/20W 4.7K OHM J
RA57	76011472	CHIP 1/20W 4.7K OHM J
RA58	76011102	CHIP 1/20W 1K OHM J
RA65	76366471	CARBON FILM 1/6W 470 OHM J
RA66	76011222	CHIP 1/20W 2.2K OHM J
RA67	76011101	CHIP 1/20W 100 OHM J
RA68	76011564	CHIP 1/20W 560K OHM J
RA69	76011333	CHIP 1/20W 33K OHM J
RA70	76011123	CHIP 1/20W 12K OHM J
RA71	76011392	CHIP 1/20W 3.9K OHM J

Location No.	Parts No.	Description
RA72	76011392	CHIP 1/20W 3.9K OHM J
RA73	76011223	CHIP 1/20W 22K OHM J
RA75	76366561	CARBON FILM 1/6W 560 OHM J
RA76	76366561	CARBON FILM 1/6W 560 OHM J
RA77	76011102	CHIP 1/20W 1K OHM J
RA78	76011101	CHIP 1/20W 100 OHM J
RA79	76011101	CHIP 1/20W 100 OHM J
RA82	76366223	CARBON FILM 1/6W 22K OHM J
RA83	76366103	CARBON FILM 1/6W 10K OHM J
RA85	76366223	CARBON FILM 1/6W 22K OHM J
RA87	76011563	CHIP 1/20W 56K OHM J
RA90	76011102	CHIP 1/20W 1K OHM J
RA91	76011392	CHIP 1/20W 3.9K OHM J
RA92	76011102	CHIP 1/20W 1K OHM J
RA93	76011102	CHIP 1/20W 1K OHM J
RA94	76011101	CHIP 1/20W 100 OHM J
RA95	76011102	CHIP 1/20W 1K OHM J
RA98	76366472	CARBON FILM 1/6W 4.7K OHM J
RB01	76366271	CARBON FILM 1/6W 270 OHM J
RB02	76366221	CARBON FILM 1/6W 220 OHM J
RB03	76366103	CARBON FILM 1/6W 10K OHM J
RB04	76366102	CARBON FILM 1/6W 1K OHM J
RB06	76366102	CARBON FILM 1/6W 1K OHM J
RB09	76366470	CARBON FILM 1/6W 47 OHM J
RB27	76366103	CARBON FILM 1/6W 10K OHM J
RB28	76366104	CARBON FILM 1/6W 100K OHM J
RB30	76011682	CHIP 1/20W 6.8K OHM J
RC12	76011102	CHIP 1/20W 1K OHM J
RC13	76011102	CHIP 1/20W 1K OHM J
RC14	76011102	CHIP 1/20W 1K OHM J
RC15	76011102	CHIP 1/20W 1K OHM J
RC16	76011102	CHIP 1/20W 1K OHM J
RC17	76011102	CHIP 1/20W 1K OHM J
RD01	76011101	CHIP 1/20W 100 OHM J
RD02	76011472	CHIP 1/20W 4.7K OHM J
RD04	76011102	CHIP 1/20W 1K OHM J
RD05	76011102	CHIP 1/20W 1K OHM J
RD07	76000445	CHIP JUMPER 1608TYPE
RD08	76000445	CHIP JUMPER 1608TYPE
RD09	76011101	CHIP 1/20W 100 OHM J
RD10	76011101	CHIP 1/20W 100 OHM J
RD15	76011101	CHIP 1/20W 100 OHM J
RD16	76011101	CHIP 1/20W 100 OHM J
RD23	76011101	CHIP 1/20W 100 OHM J
RD24	76011101	CHIP 1/20W 100 OHM J
RD25	76011563	CHIP 1/20W 56K OHM J
RD26	76011823	CHIP 1/20W 82K OHM J
RD27	76011563	CHIP 1/20W 56K OHM J
RD28	76011823	CHIP 1/20W 82K OHM J
RD29	76000445	CHIP JUMPER 1608TYPE
RI84	76011472	CHIP 1/20W 4.7K OHM J
RI85	76011472	CHIP 1/20W 4.7K OHM J
RJ02	76000445	CHIP JUMPER 1608TYPE
RJ08	76000576	CHIP JUMPER 3216TYPE
RJ09	76000576	CHIP JUMPER 3216TYPE
RJ10	76000576	CHIP JUMPER 3216TYPE
RJ12	76000576	CHIP JUMPER 3216TYPE
RJ13	76000445	CHIP JUMPER 1608TYPE
RJ19	76000445	CHIP JUMPER 1608TYPE
RJ20	76000445	CHIP JUMPER 1608TYPE
RJ21	76000445	CHIP JUMPER 1608TYPE
RJ22	76000445	CHIP JUMPER 1608TYPE
RJ23	76000445	CHIP JUMPER 1608TYPE
RP01	76011750	CHIP 1/20W 75 OHM J
RP02	76011750	CHIP 1/20W 75 OHM J
RP03	76011750	CHIP 1/20W 75 OHM J
RP04	76011681	CHIP 1/20W 680 OHM J
RP05	76011750	CHIP 1/20W 75 OHM J
RP08	76011331	CHIP 1/20W 330 OHM J
RP10	76000445	CHIP JUMPER 1608TYPE
RP12	76000445	CHIP JUMPER 1608TYPE
RP13	76011225	CHIP 1/20W 2.2M OHM K
RP15	76011331	CHIP 1/20W 330 OHM J
RP16	76011331	CHIP 1/20W 330 OHM J
RP18	76011101	CHIP 1/20W 100 OHM J
RP19	76011101	CHIP 1/20W 100 OHM J
RP20	76011472	CHIP 1/20W 4.7K OHM J
RP21	76011101	CHIP 1/20W 100 OHM J

Location No.	Parts No.	Description
RP22	76011101	CHIP 1/20W 100 OHM J
RP23	76011101	CHIP 1/20W 100 OHM J
RP24	76011331	CHIP 1/20W 330 OHM J
RP25	76011331	CHIP 1/20W 330 OHM J
RP26	76011331	CHIP 1/20W 330 OHM J
RP27	76011331	CHIP 1/20W 330 OHM J
RP28	76011331	CHIP 1/20W 330 OHM J
RP29	76011331	CHIP 1/20W 330 OHM J
RP30	76011331	CHIP 1/20W 330 OHM J
RP31	76011331	CHIP 1/20W 330 OHM J
RP32	76011331	CHIP 1/20W 330 OHM J
RP33	76011331	CHIP 1/20W 330 OHM J
RP34	76011331	CHIP 1/20W 330 OHM J
RP35	76011331	CHIP 1/20W 330 OHM J
RP36	76011331	CHIP 1/20W 330 OHM J
RP37	76011331	CHIP 1/20W 330 OHM J
RP38	76011331	CHIP 1/20W 330 OHM J
RP39	76011331	CHIP 1/20W 330 OHM J
RP40	76000445	CHIP JUMPER 1608TYPE
RP43	76000445	CHIP JUMPER 1608TYPE
RP44	76011331	CHIP 1/20W 330 OHM J
RS01	76011103	CHIP 1/20W 10K OHM J
RS02	76011104	CHIP 1/20W 100K OHM J
RS03	76011103	CHIP 1/20W 10K OHM J
RS04	76011104	CHIP 1/20W 100K OHM J
RS10	76011562	CHIP 1/20W 5.6K OHM J
RS11	76011562	CHIP 1/20W 5.6K OHM J
RS12	76011222	CHIP 1/20W 2.2K OHM J
RS13	76011101	CHIP 1/20W 100 OHM J
RS14	76011562	CHIP 1/20W 5.6K OHM J
RS15	76011562	CHIP 1/20W 5.6K OHM J
RS17	76011562	CHIP 1/20W 5.6K OHM J
RS18	76011562	CHIP 1/20W 5.6K OHM J
RS19	76011101	CHIP 1/20W 100 OHM J
RS20	76011562	CHIP 1/20W 5.6K OHM J
RS22	76011222	CHIP 1/20W 2.2K OHM J
RS23	76011102	CHIP 1/20W 1K OHM J
RS24	76011102	CHIP 1/20W 1K OHM J
RS25	76011562	CHIP 1/20W 5.6K OHM J
RS27	76366561	CARBON FILM 1/6W 560 OHM J
RS61	76552331	OXIDE METAL FILM 1/2W 330 OHM J
RS62	76552331	OXIDE METAL FILM 1/2W 330 OHM J
RT01	#1 76011102	CHIP 1/20W 1K OHM J
RT02	#1 76011102	CHIP 1/20W 1K OHM J
RT03	#1 76011102	CHIP 1/20W 1K OHM J
RT04	#1 76011472	CHIP 1/20W 4.7K OHM J
RT05	#1 76011243	CHIP 1/20W 24K OHM J
RT06	#1 76011151	CHIP 1/20W 150 OHM J
RT07	#1 76011151	CHIP 1/20W 150 OHM J
RT08	#1 76011151	CHIP 1/20W 150 OHM J
RT09	#1 76011101	CHIP 1/20W 100 OHM J
RT11	#1 76011102	CHIP 1/20W 1K OHM J
RT12	#1 76011101	CHIP 1/20W 100 OHM J
RT14	#1 76011102	CHIP 1/20W 1K OHM J
RT15	#1 76011101	CHIP 1/20W 100 OHM J
RT17	#1 76011102	CHIP 1/20W 1K OHM J
RT18	#1 76011101	CHIP 1/20W 100 OHM J
RT19	#1 76011101	CHIP 1/20W 100 OHM J
RT23	#1 76011101	CHIP 1/20W 100 OHM J
RT24	#1 76011101	CHIP 1/20W 100 OHM J
RT25	#1 76011101	CHIP 1/20W 100 OHM J
RV03	76011750	CHIP 1/20W 75 OHM J
RV05	76366223	CARBON FILM 1/6W 22K OHM J
RV06	76011472	CHIP 1/20W 4.7K OHM J
RV07	76011103	CHIP 1/20W 10K OHM J
RV10	76011101	CHIP 1/20W 100 OHM J
RV12	76366101	CARBON FILM 1/6W 100 OHM J
RV14	76366101	CARBON FILM 1/6W 100 OHM J
RV15	76011101	CHIP 1/20W 100 OHM J
RV16	76366101	CARBON FILM 1/6W 100 OHM J
RV17	76011101	CHIP 1/20W 100 OHM J
RV20	76366102	CARBON FILM 1/6W 1K OHM J
RV21	76011151	CHIP 1/20W 150 OHM J
RV22	76366102	CARBON FILM 1/6W 1K OHM J
RV24	76552101	OXIDE METAL FILM 1/2W 100 OHM J
RV25	76011750	CHIP 1/20W 75 OHM J
RV26	76011101	CHIP 1/20W 100 OHM J
RV29	76011223	CHIP 1/20W 22K OHM J

Location No.	Parts No.	Description
RV30	76011750	CHIP 1/20W 75 OHM J
RV31	76011750	CHIP 1/20W 75 OHM J
RV33	76011331	CHIP 1/20W 330 OHM J
RV34	76011331	CHIP 1/20W 330 OHM J
RV90	76011101	CHIP 1/20W 100 OHM J
RV91	76011101	CHIP 1/20W 100 OHM J
RV92	76011103	CHIP 1/20W 10K OHM J
RX01	76872331	CHIP 1/16W 330 OHM J
RX02	76366472	CARBON FILM 1/6W 4.7K OHM J
RX04	76872472	CHIP 1/16W 4.7K OHM J
RX05	76872103	CHIP 1/16W 10K OHM J
RX06	76011220	CHIP 1/20W 22 OHM J
RX07	76011103	CHIP 1/20W 10K OHM J
RX08	76011684	CHIP 1/20W 680K OHM J
RX09	76011224	CHIP 1/20W 220K OHM J
RX12	76000445	CHIP JUMPER 1608TYPE
RX13	76011154	CHIP 1/20W 150K OHM J
RX14	76011823	CHIP 1/20W 82K OHM J
RX15	76000445	CHIP JUMPER 1608TYPE
RX16	76011823	CHIP 1/20W 82K OHM J
RX17	76011101	CHIP 1/20W 100 OHM J
RX18	76998103	CHIP 1/16W 10K OHM
RX21	76011103	CHIP 1/20W 10K OHM J
RX24	76872242	CHIP 1/16W 2.4K OHM J
RX25	76011473	CHIP 1/20W 47K OHM J
RX29	76552331	OXIDE METAL FILM 1/2W 330 OHM J
RX30	76872471	CHIP 1/16W 470 OHM J
RX31	76872103	CHIP 1/16W 10K OHM J
RX33	76011271	CHIP 1/20W 270 OHM J
RX34	76366103	CARBON FILM 1/6W 10K OHM J
RX35	76011101	CHIP 1/20W 100 OHM J
RX36	76011101	CHIP 1/20W 100 OHM J
RX37	76011153	CHIP 1/20W 15K OHM J
RX38	76011124	CHIP 1/20W 120K OHM J
RX39	76011471	CHIP 1/20W 470 OHM J
RX40	76011101	CHIP 1/20W 100 OHM J
RX41	76011153	CHIP 1/20W 15K OHM J
RX42	76872823	CHIP 1/16W 82K OHM J
RX43	76872222	CHIP 1/16W 2.2K OHM J
RX44	76872392	CHIP 1/16W 3.9K OHM J
RX46	76011472	CHIP 1/20W 4.7K OHM J
RX47	76011472	CHIP 1/20W 4.7K OHM J
RX48	76011124	CHIP 1/20W 120K OHM J
RX51	76011102	CHIP 1/20W 1K OHM J
RX53	76011101	CHIP 1/20W 100 OHM J
RX54	76011101	CHIP 1/20W 100 OHM J
RX55	76011361	CHIP 1/20W 360 OHM J
RX56	76011622	CHIP 1/20W 6.2K OHM J
RX57	76011102	CHIP 1/20W 1K OHM J
RX60	76011102	CHIP 1/20W 1K OHM J
RY01	76011274	CHIP 1/20W 270K OHM J
RY02	76011101	CHIP 1/20W 100 OHM J
RY04	76011102	CHIP 1/20W 1K OHM J
RY05	76011101	CHIP 1/20W 100 OHM J
RY07	76011470	CHIP 1/20W 47 OHM J
RY08	76011470	CHIP 1/20W 47 OHM J
RY09	76011100	CHIP 1/20W 10 OHM J
RY10	76011101	CHIP 1/20W 100 OHM J
RY11	76011101	CHIP 1/20W 100 OHM J
RY12	76011101	CHIP 1/20W 100 OHM J
RY13	76000445	CHIP JUMPER 1608TYPE
RY14	76000445	CHIP JUMPER 1608TYPE
RY15	76011183	CHIP 1/20W 18K OHM J
RY16	76011183	CHIP 1/20W 18K OHM J
RY17	76011152	CHIP 1/20W 1.5K OHM J
RY18	76011122	CHIP 1/20W 1.2K OHM J
RY33	76011272	CHIP 1/20W 2.7K OHM J
RY34	76011822	CHIP 1/20W 8.2K OHM J
RY35	76011102	CHIP 1/20W 1K OHM J
RY36	76011561	CHIP 1/20W 560 OHM J
RY37	76011102	CHIP 1/20W 1K OHM J
RY38	76011471	CHIP 1/20W 470 OHM J
RY39	76011272	CHIP 1/20W 2.7K OHM J
RY40	76011822	CHIP 1/20W 8.2K OHM J
RY41	76011102	CHIP 1/20W 1K OHM J
RY42	76011561	CHIP 1/20W 560 OHM J
RY43	76011102	CHIP 1/20W 1K OHM J
RY44	76011471	CHIP 1/20W 470 OHM J

Location No.	Parts No.	Description
RY45	76011272	CHIP 1/20W 2.7K OHM J
RY46	76011822	CHIP 1/20W 8.2K OHM J
RY47	76011102	CHIP 1/20W 1K OHM J
RY48	76011561	CHIP 1/20W 560 OHM J
RY49	76011102	CHIP 1/20W 1K OHM J
RY50	76011471	CHIP 1/20W 470 OHM J
RY51	76011272	CHIP 1/20W 2.7K OHM J
RY52	76011822	CHIP 1/20W 8.2K OHM J
RY53	76011102	CHIP 1/20W 1K OHM J
RY54	76011561	CHIP 1/20W 560 OHM J
RY55	76011102	CHIP 1/20W 1K OHM J
RY56	76011471	CHIP 1/20W 470 OHM J
RY57	76011272	CHIP 1/20W 2.7K OHM J
RY58	76011822	CHIP 1/20W 8.2K OHM J
RY59	76011102	CHIP 1/20W 1K OHM J
RY60	76011561	CHIP 1/20W 560 OHM J
RY61	76011102	CHIP 1/20W 1K OHM J
RY62	76011471	CHIP 1/20W 470 OHM J
RY63	76011102	CHIP 1/20W 1K OHM J
RY64	76011182	CHIP 1/20W 1.8K OHM J
RY65	76011102	CHIP 1/20W 1K OHM J
RY66	76011101	CHIP 1/20W 100 OHM J
RY67	76011101	CHIP 1/20W 100 OHM J
RY68	76011101	CHIP 1/20W 100 OHM J
COILS & TRANSFORMERS		
D444D	23103347	FERRITE CORE 3.5X5X1.3 HF70BB 3.5X5X1.3
G104	23248423	COIL CHOKE TLN3481AC
G105	23248423	COIL CHOKE TLN3481AC
G106	23103308	FERRITE CORE TEM2011AO 3.5X4.5
G107	23103308	FERRITE CORE TEM2011AO 3.5X4.5
G108	23103308	FERRITE CORE TEM2011AO 3.5X4.5
G109	23103308	FERRITE CORE TEM2011AO 3.5X4.5
G410	23357877	DIODE ZENER MTZJ18B
G460	23103320	COIL CHOKE TEM2011
G812	23103308	FERRITE CORE TEM2011AO 3.5X4.5
G894	23289043	COIL PEAKING TRF4100AU
GL101	23221161	COIL PEAKING TRF4220AJ
L102	23103308	FERRITE CORE TEM2011AO 3.5X4.5
L103	23103308	FERRITE CORE TEM2011AO 3.5X4.5
L104	23103311	FERRITR CHOKE TEM2014AO 3.5X5X2
L300	23103308	FERRITE CORE TEM2011AO 3.5X4.5
L301	23103311	FERRITR CHOKE TEM2014AO 3.5X5X2
L302	23103308	FERRITE CORE TEM2011AO 3.5X4.5
L303	23103308	FERRITE CORE TEM2011AO 3.5X4.5
L401	23103308	FERRITE CORE TEM2011AO 3.5X4.5
L402	23103308	FERRITE CORE TEM2011AO 3.5X4.5
L441	23233110	COIL LINEARITY TLN2227AH
L442	23248418	COIL CHOKE TLN3459AH
L460	23103320	COIL CHOKE TEM2011
L461	23248433	COIL CHOKE TLN3500AH
L462	23231459	COIL DEFLECTION YOKE TDY829DT
L462A	23006010	FERRITE SHEET SPOILER POSI
L462B	23006011	FERRITE SHEET SPOILER NEGA
L462C	23199746	CONVER COMPENSATOR XH
L462D	23199746	CONVER COMPENSATOR XH
L464	23103308	FERRITE CORE TEM2011AO 3.5X4.5
L491	23248413	COIL CHOKE TLN3351AD
L501	23246624	COIL CHIP TRF4100CC
L502	23246624	COIL CHIP TRF4100CC
L503	23246624	COIL CHIP TRF4100CC
L504	23103239	INDUCTOR BEAD TEM2143AD
L702	23103323	FERRITE CORE HC5-035
L704	23103308	FERRITE CORE TEM2011AO 3.5X4.5
L705	23103308	FERRITE CORE TEM2011AO 3.5X4.5
L706	23289043	COIL PEAKING TRF4100AU
△ L801	23248389	COIL CHOKE 11X17H 100MMHK 1.2A TLN3299AA
△ L802	23217687	TRANSFORMER CHOKE 24MH 2A TPW2064AL
L803	23217687	TRANSFORMER CHOKE 24MH 2A TPW2064AL
L805	23248423	COIL CHOKE TLN3481AC
L806	23248423	COIL CHOKE TLN3481AC
L811	23103308	FERRITE CORE TEM2011AO 3.5X4.5
L815	23103308	FERRITE CORE TEM2011AO 3.5X4.5
L817	23103309	FERRITE CORE TEM2004AO 3.5X10X0.9
L883	23221142	COIL CHOKE TRF9253D
L885	23248389	COIL CHOKE 11X17H 100MMHK 1.2A TLN3299AA
L886	23103308	FERRITE CORE TEM2011AO 3.5X4.5
L889	23248389	COIL CHOKE 11X17H 100MMHK 1.2A TLN3299AA

Location No.	Parts No.	Description
L891	23103311	FERRITR CHOKE TEM2014AO 3.5X5X2
L892	23103311	FERRITR CHOKE TEM2014AO 3.5X5X2
L893	23248389	COIL CHOKE 11X17H 100MMHK 1.2A TLN3299AA
L896	23103308	FERRITE CORE TEM2011AO 3.5X4.5
L897	23248389	COIL CHOKE 11X17H 100MMHK 1.2A TLN3299AA
L898	23248389	COIL CHOKE 11X17H 100MMHK 1.2A TLN3299AA
△ L901	23200187	COIL DG ALU 48T-8TYPE TSB 2389EAG
L902	23289054	COIL PEAKING TRF4101AU
L903	23289054	COIL PEAKING TRF4101AU
L904	23289054	COIL PEAKING TRF4101AU
L905	23289045	COIL PEAKING TRF4150AU
L906	23289045	COIL PEAKING TRF4150AU
L907	23289045	COIL PEAKING TRF4150AU
L908	23289043	COIL PEAKING TRF4100AU
L911	23289043	COIL PEAKING TRF4100AU
LA01	23289043	COIL PEAKING TRF4100AU
LA02	23262307	COIL IF TRF1237AH
LA03	23289022	COIL PEAKING TRF4100AT
LC01	23221141	COIL CHOKE TRF9240AC
LC02	23221141	COIL CHOKE TRF9240AC
LC03	23221141	COIL CHOKE TRF9240AC
LC09	23103828	INDUCTOR BEAD TEM2121M
LC10	23103828	INDUCTOR BEAD TEM2121M
LC19	23103828	INDUCTOR BEAD TEM2121M
LC20	23103828	INDUCTOR BEAD TEM2121M
LC21	23103828	INDUCTOR BEAD TEM2121M
LC22	23103828	INDUCTOR BEAD TEM2121M
LC23	23103828	INDUCTOR BEAD TEM2121M
LC24	23103828	INDUCTOR BEAD TEM2121M
LD01	23103825	INDUCTOR BEAD TEM2118M
LD02	23103825	INDUCTOR BEAD TEM2118M
LP01	23246624	COIL CHIP TRF4100CC
LP02	23246624	COIL CHIP TRF4100CC
LP03	23246624	COIL CHIP TRF4100CC
LP04	23246624	COIL CHIP TRF4100CC
LP05	23246624	COIL CHIP TRF4100CC
LP06	23103239	INDUCTOR BEAD TEM2143AD
LP08	23246624	COIL CHIP TRF4100CC
LP09	23246624	COIL CHIP TRF4100CC
LP10	23246624	COIL CHIP TRF4100CC
LP17	23246624	COIL CHIP TRF4100CC
LP18	23246624	COIL CHIP TRF4100CC
LP19	23246624	COIL CHIP TRF4100CC
LT01	#1 23246624	COIL CHIP TRF4100CC
LT05	#1 23246624	COIL CHIP TRF4100CC
LV01	23289978	COIL PEAKING TRF4100AJ
LV02	23103310	FERRITE CORE TEM2028AC 7.5X6.4X8 0.5A
LX01	23289051	COIL PEAKING TRF4470AU
LX02	23289054	COIL PEAKING TRF4101AU
LY01	23103239	INDUCTOR BEAD TEM2143AD
LY02	23103828	INDUCTOR BEAD TEM2121M
LY03	23103239	INDUCTOR BEAD TEM2143AD
LY04	23103239	INDUCTOR BEAD TEM2143AD
LY05	23103239	INDUCTOR BEAD TEM2143AD
LY10	23246624	COIL CHIP TRF4100CC
LY11	23246624	COIL CHIP TRF4100CC
LY12	23246653	COIL CHIP TRF4150CG
LY13	23246653	COIL CHIP TRF4150CG
LY14	23246653	COIL CHIP TRF4150CG
LY15	23246653	COIL CHIP TRF4150CG
LY16	23246653	COIL CHIP TRF4150CG
LY17	23246645	COIL CHIP TRF41R5CG
LY18	23246624	COIL CHIP TRF4100CC
LY19	23246624	COIL CHIP TRF4100CC
LY22	23246624	COIL CHIP TRF4100CC
Q404E	23103347	CORE FERRITE CORE 3.5X5X1.3 HF70BB 3.5X5X1.3
T401	23224396	TRANSFORMER TLN1080AH
△ T461	23236954	TRANSFORMER FLY-BACK TFB4222AT
△ T802	23211842	COIL LINE FILTER TRF3229AR
△ T803	23211843	COIL LINE FILTER TRF3234AR
△ T862	23217813	TRANSFORMER CONVERTER TPW3509AW
Z801	23103778	FERRITE CORE TFE1008
SEMICONDUCTORS		
D101	23362103	DIODE ZENER DZ33 BS B
D301	23357372	DIODE EU2JGF-41U2
D302	23357372	DIODE EU2JGF-41U2
D303	23362228	DIODE VRM=200V 1N4003F

Location No.	Parts No.	Description
D304	23357917	DIODE SC570A
D306	23362228	DIODE VRM=200V 1N4003F
D308	23357372	DIODE EU2JGF-41U2
D406	23357372	DIODE EU2JGF-41U2
D408	23357372	DIODE EU2JGF-41U2
D441	23362081	DIODE ZENER DZ9.1 BS C
D444	23357701	DIODE FMQ-3GU
D445	23357372	DIODE EU2JGF-41U2
D462	23362094	DIODE ZENER DZ15 BS B
D465	23357372	DIODE EU2JGF-41U2
D470	23362107	DIODE ZENER DZ36 BS B
D501	23357811	DIODE ZENER MTZJ2.0A
D502	23362140	DIODE KDS160-RTK
D503	23362140	DIODE KDS160-RTK
D505	23362140	DIODE KDS160-RTK
D509	23362140	DIODE KDS160-RTK
D510	23362042	DIODE ZENER UDZS6.8B
D670	23362140	DIODE KDS160-RTK
D671	23362140	DIODE KDS160-RTK
D672	23362140	DIODE KDS160-RTK
D673	23362140	DIODE KDS160-RTK
D674	23362140	DIODE KDS160-RTK
D680	23362140	DIODE KDS160-RTK
D681	23362140	DIODE KDS160-RTK
D682	23362140	DIODE KDS160-RTK
D683	23362140	DIODE KDS160-RTK
D704	23362111	DIODE 1SS133
D705	23362111	DIODE 1SS133
D715	23362111	DIODE 1SS133
D721	23362111	DIODE 1SS133
D801	23362217	DIODE BRG. VRM600V IO6A GBU6J-T1
D803	23362070	DIODE ZENER DZ5.6 BS B
D804	23362094	DIODE ZENER DZ15 BS B
D805	23357104	DIODE 1SS244
D806	23357372	DIODE EU2JGF-41U2
D807	23362099	DIODE ZENER DZ27 BS B
D810	23362098	DIODE ZENER DZ22 BS B
D811	23362111	DIODE 1SS133
D815	23362103	DIODE ZENER DZ33 BS B
D818	23362098	DIODE ZENER DZ22 BS B
D828	23362111	DIODE 1SS133
D830	23357747	DIODE ZENER MA8062-L
D831	23357767	DIODE ZENER MA8110-L
D844	23357747	DIODE ZENER MA8062-L
D845	23362111	DIODE 1SS133
D849	23362078	DIODE ZENER DZ8.2 BS C
D882	23357364	DIODE RU4JGF- M2
D885	23357471	DIODE RU4DG-3AM2
D891	23357471	DIODE RU4DG-3AM2
D892	23357471	DIODE RU4DG-3AM2
D896	23357372	DIODE EU2JGF-41U2
D901	23362111	DIODE 1SS133
D904	23362111	DIODE 1SS133
D905	23362111	DIODE 1SS133
D906	23362111	DIODE 1SS133
D907	23362111	DIODE 1SS133
D908	23362111	DIODE 1SS133
D909	23362111	DIODE 1SS133
D911	23357372	DIODE EU2JGF-41U2
D921	23357372	DIODE EU2JGF-41U2
D931	23362111	DIODE 1SS133
D932	23362111	DIODE 1SS133
D933	23362111	DIODE 1SS133
D934	23362111	DIODE 1SS133
D941	23362111	DIODE 1SS133
D942	23362111	DIODE 1SS133
D943	23362111	DIODE 1SS133
D946	23362111	DIODE 1SS133
D963	23362111	DIODE 1SS133
D964	23362111	DIODE 1SS133
D965	23362111	DIODE 1SS133
D966	23362111	DIODE 1SS133
DA01	23362111	DIODE 1SS133
DA02	23362140	DIODE KDS160-RTK
DA30	23362111	DIODE 1SS133
DB01	23358577	DIODE LED RED/GREEN BT-H684W
DB03	23357818	DIODE ZENER MTZJ2.7B
DB30	23362111	DIODE 1SS133

Location No.	Parts No.	Description
DD01	23362138	DIODE KDS114-RTK
DX01	23362140	DIODE KDS160-RTK
DX02	23362140	DIODE KDS160-RTK
DX03	23362085	DIODE ZENER DZ11 BS A
DX04	23362102	DIODE ZENER DZ33 BS A
DX06	23362140	DIODE KDS160-RTK
DX07	23362140	DIODE KDS160-RTK
DX08	23357768	DIODE ZENER MA8110-M
DX09	23362042	DIODE ZENER UDZS6.8B
DX10	23362140	DIODE KDS160-RTK
KB01	23085842	IC REMOCON RECEIVER ROM-N338TB
Q301	23085526	IC LA7833-S-E
Q302	23205346	TRANSISTOR KTA2014Y/P
Q402	23205479	TRANSISTOR FET 2SK941(F)
Q4021	23205358	TRANSISTOR KTC3875S Y/P
Q4022	23205357	TRANSISTOR KTA1504S Y/P
Q404	23205405	TRANSISTOR 2SC5859 (FAQ)
Q404B	23850638	INSULATOR TRANSISTOR AC263
Q460	23205350	TRANSISTOR FET 2SK2920 (Q)
Q470	23205516	TRANSISTOR 2SA1320(F)
Q501	23009369	IC TA1360AFG
Q502	23205357	TRANSISTOR KTA1504S Y/P
Q503	23205357	TRANSISTOR KTA1504S Y/P
Q504	23205357	TRANSISTOR KTA1504S Y/P
Q505	23205357	TRANSISTOR KTA1504S Y/P
Q509	23205357	TRANSISTOR KTA1504S Y/P
Q510	23205357	TRANSISTOR KTA1504S Y/P
Q511	23205357	TRANSISTOR KTA1504S Y/P
Q512	23205357	TRANSISTOR KTA1504S Y/P
Q610	23085693	IC AN5277
Q623	23205222	TRANSISTOR PNP R1=R2=47KOHM SRA2204S (SOT-23)
Q670	23205346	TRANSISTOR KTA2014Y/P
Q671	23205424	TRANSISTOR KTC2875B/P
Q672	23205424	TRANSISTOR KTC2875B/P
Q705	23205376	TRANSISTOR 2SC5343-Y (BULK)
Q706	23205376	TRANSISTOR 2SC5343-Y (BULK)
Q707	23205314	TRANSISTOR 2SC752 (G) TM-Y (F)
Q709	23205376	TRANSISTOR 2SC5343-Y (BULK)
Q710	23205372	TRANSISTOR 2SA1980-Y (BULK)
Q711	23205367	TRANSISTOR 2SA1930
Q712	23205368	TRANSISTOR 2SC5171(Q)
Q719	23205376	TRANSISTOR 2SC5343-Y (BULK)
Q720	23205376	TRANSISTOR 2SC5343-Y (BULK)
Q801	23135065	IC STRX6469
Q802	23205292	TRANSISTOR 2SD2396
Q803	23009844	IC REGULATOR +9V 4% S7809PI
Q805	23205229	TRANSISTOR SRC1205M
Q821	23009843	IC S7805PI
Q822	23009843	IC S7805PI
Q823	23009843	IC S7805PI
Q824	23009844	IC REGULATOR +9V 4% S7809PI
△ Q826	23000823	IC PHOTO COUPLER TLP421F (GR)
Q827	23085364	IC SE125N LF4
Q830	23205292	TRANSISTOR 2SD2396
Q831	23009844	IC REGULATOR +9V 4% S7809PI
Q840	23085506	IC L78MR05-FA-E
Q841	23205358	TRANSISTOR KTC3875S Y/P
Q842	23205358	TRANSISTOR KTC3875S Y/P
Q880	23205357	TRANSISTOR KTA1504S Y/P
Q901	23205475	TRANSISTOR 2SC4544 (F)
Q902	23205376	TRANSISTOR 2SC5343-Y (BULK)
Q903	23205475	TRANSISTOR 2SC4544 (F)
Q904	23205376	TRANSISTOR 2SC5343-Y (BULK)
Q905	23205475	TRANSISTOR 2SC4544 (F)
Q906	23205376	TRANSISTOR 2SC5343-Y (BULK)
Q907	23205340	TRANSISTOR 2SA1020-Y (F)
Q908	23205202	TRANSISTOR 2SC5344Y
Q910	23205376	TRANSISTOR 2SC5343-Y (BULK)
QA01	23085892	IC MCU 1CHIP 8BIT 8M 42P TMP88CS38BN-***2
QA02	23085765	IC AT24C16A-10PU2.7
QA11	23205358	TRANSISTOR KTC3875S Y/P
QA13	23205357	TRANSISTOR KTA1504S Y/P
QA14	23205358	TRANSISTOR KTC3875S Y/P
QA15	23205360	TRANSISTOR 2SA1980S-Y (BULK)
QA16	23085433	IC BD4742G
QA30	23089077	IC FLASH MCU 1CHIP QFP 64P TMP86FS49AFG
QA31	23205358	TRANSISTOR KTC3875S Y/P
QB02	23205376	TRANSISTOR 2SC5343-Y (BULK)

Location No.	Parts No.	Description
QB03	23205372	TRANSISTOR 2SA1980-Y (BULK)
QB20	23205320	TRANSISTOR RN1201(F)
QB21	23205376	TRANSISTOR 2SC5343-Y (BULK)
QB30	23205358	TRANSISTOR KTC3875S Y/P
QD01	23009522	IC MSP3410G
QD03	23205347	TRANSISTOR KTC4075Y/P
QD04	23205347	TRANSISTOR KTC4075Y/P
QI16	23205214	TRANSISTOR NPN R1=R2=10KOHM SRC1202U (SOT-323)
QI17	23205214	TRANSISTOR NPN R1=R2=10KOHM SRC1202U (SOT-323)
QP01	23085829	IC PIXCELWORKS SCALAR
QP02	23085029	IC BA15BC0FP-E2
QP03	23085026	IC BA33BC0FP-E2
QP04	23085026	IC BA33BC0FP-E2
QP05	23085030	IC BA18BC0FP
QP06	23000904	IC BA25BC0FP
QP07	23085030	IC BA18BC0FP
QP08	23085827	IC CMOS SDRAM
QS01	23205347	TRANSISTOR KTC4075Y/P
QS02	23205347	TRANSISTOR KTC4075Y/P
QS03	23205424	TRANSISTOR KTC2875B/P
QS04	23205424	TRANSISTOR KTC2875B/P
QT01	#1 23085828	IC TELETEXT DECOCER
QT02	#1 23205357	TRANSISTOR KTA1504S Y/P
QT03	#1 23205206	TRANSISTOR NPN R1=R2=10KOHM SRC1202S (SOT-23)
QT04	#1 23205357	TRANSISTOR KTA1504S Y/P
QT05	#1 23205357	TRANSISTOR KTA1504S Y/P
QT06	#1 23205357	TRANSISTOR KTA1504S Y/P
QV01	23085371	IC MM1495XF
QV02	23205376	TRANSISTOR 2SC5343-Y (BULK)
QV03	23205347	TRANSISTOR KTC4075Y/P
QX01	23085309	IC TA1317ANG
QX03	23205358	TRANSISTOR KTC3875S Y/P
QX04	23205358	TRANSISTOR KTC3875S Y/P
QX07	23205327	TRANSISTOR RN1406(F)
QX08	23205327	TRANSISTOR RN1406(F)
QX53	23205347	TRANSISTOR KTC4075Y/P
QY01	23085835	IC VIDEO DECODER Y/C SEPA
QY02	23205358	TRANSISTOR KTC3875S Y/P
QY07	23205358	TRANSISTOR KTC3875S Y/P
QY08	23205357	TRANSISTOR KTA1504S Y/P
QY09	23205358	TRANSISTOR KTC3875S Y/P
QY10	23205357	TRANSISTOR KTA1504S Y/P
QY11	23205358	TRANSISTOR KTC3875S Y/P
QY12	23205357	TRANSISTOR KTA1504S Y/P
QY13	23205358	TRANSISTOR KTC3875S Y/P
QY14	23205357	TRANSISTOR KTA1504S Y/P
QY15	23205358	TRANSISTOR KTC3875S Y/P
QY16	23205357	TRANSISTOR KTA1504S Y/P
MISCELLANEOUS		
B102	23974994	BAND
B207	23738088	SCREW BTBW3X12 ECO
B211	23738086	SCREW BTB4X16 ECO
B212	23845859	HOLDER WIRE PVC-C0AT L=70MM
B214	23738088	SCREW BTBW3X12ECO
BB01A	23713729	SOCKET B-B 8P 2.5MM
BB02A	23713202	SOCKET B-B 16P
BB02B	23713201	PLUG B-B 16P
C822A	23960136	ADHESIVE SILICONE TSE3843-W
D444B	23717240	SCREW
D444E	23960136	ADHESIVE SILICONE TSE3843-W
D801B	23738136	SCREW 3X10MM
E947	23965900	TAPE GLASS-CLOTH W/ADHESIVE W=18 T=0.18
△ F470	23144210	FUSE 250V 1A
F470A	23165469	FUSE HOLDER 5.2 DFH-001
F470B	23165469	FUSE HOLDER 5.2 DFH-001
△ F801	23144330	FUSE CARTRIDGE 250V 5A 5.2X20
F801A	23165469	FUSE HOLDER 5.2 DFH-001
△ F801B	23165469	FUSE HOLDER 5.2 DFH-001
F802	23144302	FUSE CARTRIDGE 250V 4A 5.2X20
F802A	23165469	FUSE HOLDER 5.2 DFH-001
F802B	23165469	FUSE HOLDER 5.2 DFH-001
J03C	23171400	WIRE PVC SOLDER-PLATED 300V 7/16 BRN UL CSA
J05E	23171400	WIRE PVC SOLDER-PLATED 300V 7/16 BRN UL CSA
KB01A	23965241	TAPE CC #12 10MM L30M
M461A	23192244	CABLE ANODE CAP ASSY TCC5600BD
M461B	23507789	CABLE FOCUS
M461C	23507817	CABLE SCREEN

Location No.	Parts No.	Description
N01A	23960136	ADHESIVE SILICONE TSE3843-W
N02B	23960136	ADHESIVE SILICONE TSE3843-W
N03C	23965241	TAPE CC #12 10MM L30M
N04D	23965241	TAPE CC #12 10MM L30M
N05E	23965241	TAPE CC #12 10MM L30M
N07G	23960136	ADHESIVE SILICONE TSE3843-W
N724	23965900	TAPE GLASS-CLOTH W/ADHESIVE W=18 T=0.18
N728	23960101	SILICONE RUBBER TSE-382 RTV
P107	23713756	PLUG 5P 2.5MM G B5B-EH-F1-TV4
P206	23713757	PLUG 6P 2.5MM G B6B-EH-F1-TV4
P501B	23713758	PLUG 7P 2.5MM G B7B-EH-F1-TV4
P511B	23713756	PLUG 5P 2.5MM G B5B-EH-F1-TV4
P601	23713755	PLUG 4P 2.5MM G B4B-EH-F1-TV4
P661	23023116	PLUG HEAD PHONE JACK 3.5MM PJ3-14-7
P701A	23713776	PLUG 3P 2.5MM W S3B-EH
P701B	23713754	PLUG 3P 2.5MM G B3B-EH-F1-TV4
P704A	23713755	PLUG 4P 2.5MM G B4B-EH-F1-TV4
P704B	23713755	PLUG 4P 2.5MM G B4B-EH-F1-TV4
△ P801	23372344	POWER CORD CEE FL250V2.5A NT009AV - 2.5M
P810A	23164725	PLUG 2P
P810B	23164725	PLUG 2P
P903A	23713758	PLUG 7P 2.5MM G B7B-EH-F1-TV4
P903B	23713758	PLUG 7P 2.5MM G B7B-EH-F1-TV4
P910	23164725	PLUG 2P
PD01	23023448	PLUG PLUG 8P FULL B8PS-TB-2 (LF)(SN)
PD02	23023394	PLUG B15PS-TB-2
PP01A	23713731	SOCKET B-B 25P 1.5MM JDV-R25LB-10-1
PP01B	23713716	PLUG B-B 1.5MM 25P JDV-PS25LB-10-1
PP02A	23713731	SOCKET B-B 25P 1.5MM JDV-R25LB-10-1
PP02B	23713716	PLUG B-B 1.5MM 25P JDV-PS25LB-10-1
PV02	23023258	JACK 3P MTJ-032-39BBA-432
PV03	23023429	JACK 11P+1SV (4SW) -852V2-01 NI FE LF
Q301B	23717241	SCREW BITTB3X8 ECO
Q404C	23717240	SCREW
Q404F	23960136	ADHESIVE SILICONE TSE3843-W
Q610B	23717241	SCREW BITTB3X8 ECO
Q821B	23717240	SCREW
Q822B	23717240	SCREW
Q823B	23717240	SCREW
Q824B	23717240	SCREW
Q830B	23717240	SCREW
Q840B	23717240	SCREW
RA98A	23965241	TAPE CC #12 10MM L30M
△ S801	23344527	SWITCH POWER KDC-A11(E221)
SA01	23344516	SWITCH TACTING TSV TYP TSVB-1
SA02	23344516	SWITCH TACTING TSV TYP TSVB-1
SA03	23344516	SWITCH TACTING TSV TYP TSVB-1
SA04	23344516	SWITCH TACTING TSV TYP TSVB-1
SA06	23344516	SWITCH TACTING TSV TYP TSVB-1
SA07	23344516	SWITCH TACTING TSV TYP TSVB-1
△ SR83	23146585	RELAY DC12V 2M G5PA-2 DC12
△ V901A	23903174	SOCKET CRT ISH46S-EN ING
V901B	23102508	MAGNET MAG4009
V901D	23528016	RUBBER WEDGE MEDIUM W10H15L50 TRWMED01T
V901M	23102558	MAGNET PK MAG-1122
W661	23351292	SPEAKER SPK1410AM 60X120 8-OHM 10W
W662	23351292	SPEAKER SPK1410AM 60X120 8-OHM 10W
X501	23153721	CERAMIC RESONATOR 503KHZ
XA01	23153568	CERAMIC RESONATOR 16MHZ 50OHM TCR1084AM
XA30	23153568	CERAMIC RESONATOR 16MHZ 50OHM TCR1084AM
XD01	23153490	CRYSTAL 18.432 20PPM CL=13PF
XP01	23153606	CRYSTAL RESONATOR 10MHZ
XT01	#1 23153930	CRYSTAL
XX51	23153721	CERAMIC RESONATOR 503KHZ
XY01	23153841	CRYSTAL 42.0 25PPM 60OHM 7PF
Z889	23144263	PROTECTOR 491SERIES 125V 4A
Z890	23144264	PROTECTOR 491SERIES 125V 5A
Z891	23144264	PROTECTOR 491SERIES 125V 5A
PC BOARD ASSEMBLIES		
* U901	23764381	PC BOARD ASSY CRT/D PD2211
* U902	23764554	PC BOARD ASSY MAIN PD2252
* U903A	#1 23764749	PC BOARD ASSY DIGITAL PD2215B-1
* #2 23764746		PC BOARD ASSY DIGITAL PD2215A-1
* U903B	23764384	PC BOARD ASSY MTS PD2215-2
* U904	23764555	PC BOARD ASSY FRONT PD2216D

Location No.	Parts No.	Description
PICTURE TUBE		
△ V901	23324093	PICTURE TUBE A68LZU185X
TUNER		
H001	23321544	TUNER ENG39A18GF
ACCESSORIES		
A701	23015086	CARTON BOX
K902	23306635	REMOCON HAND UNIT IR CT-90239
Y101A	23566755	OWNERS MANUAL ENGLISH
Y101B	23566665	OWNERS MANUAL RUSSIAN
Y120	23943846	BAG POLY
CABINET PARTS		
A201	#1 23533892	COVER FRONT ASSY 29CZ8UR
	#2 23533919	COVER FRONT ASSY 29CZ8LR
A401	23532083	COVER BACK COVER PROPER
A423	23929522	WASHER T=1.0
A504	23738086	SCREW BTB4X16 ECO
A508	23738086	SCREW BTB4X16 ECO
A522	23738086	SCREW BTB4X16 ECO
A702A	23946119	PACKING TOP
A702B	23946120	PACKING BOTTOM
A902	23428371	DOOR FRONT
A905	23445914	BUTTON POWER
A911	23436893	HANDLE
A914	23738088	SCREW BTBW3X12 ECO
A915	23738085	SCREW BTB4X12 ECO
E922	23845564	CLAMPER

MAIN BOARD PD2252
BOTTOM (FOIL) SIDE

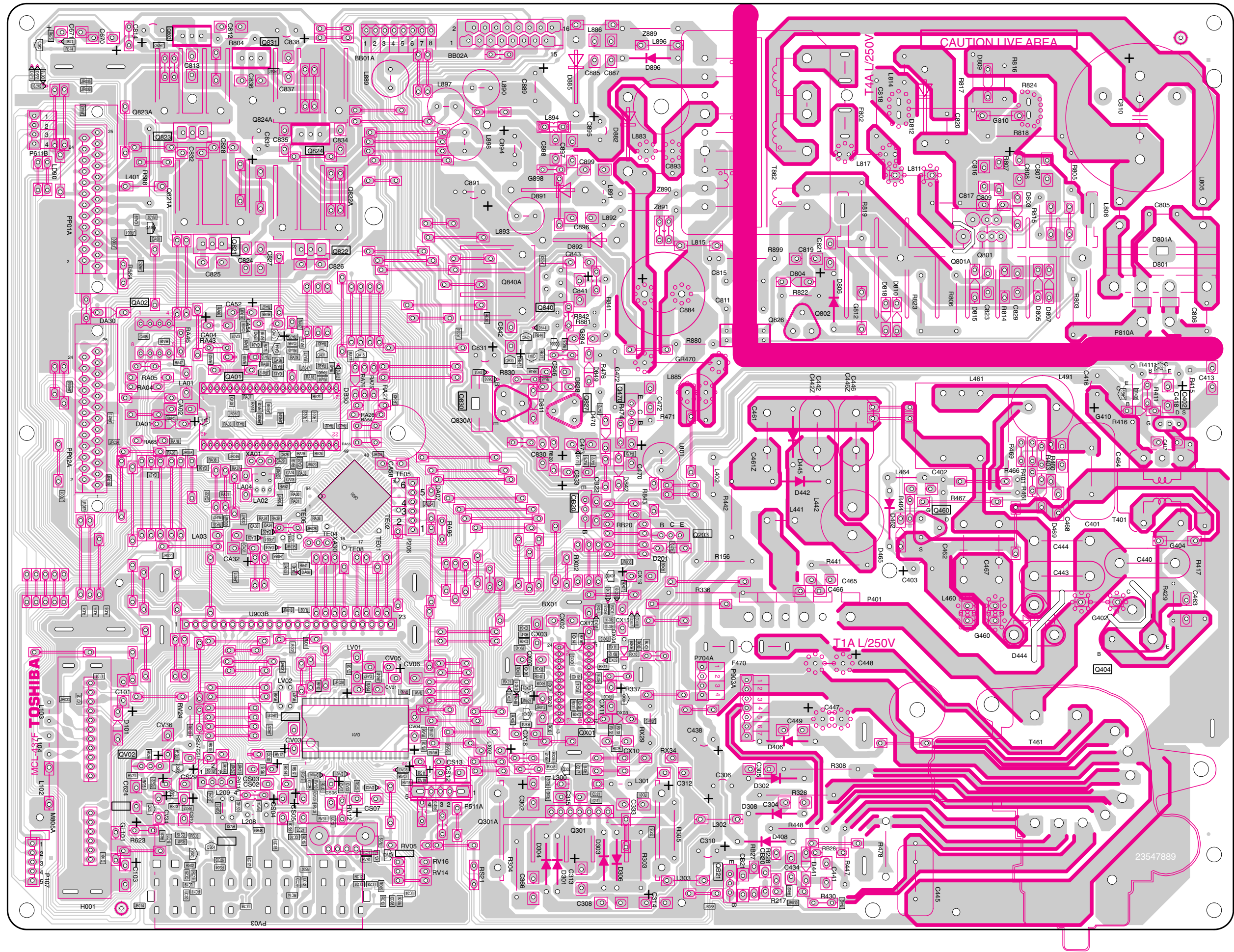

DIGITAL BOARD PD2215-1
TOP (COMPONENT) SIDE

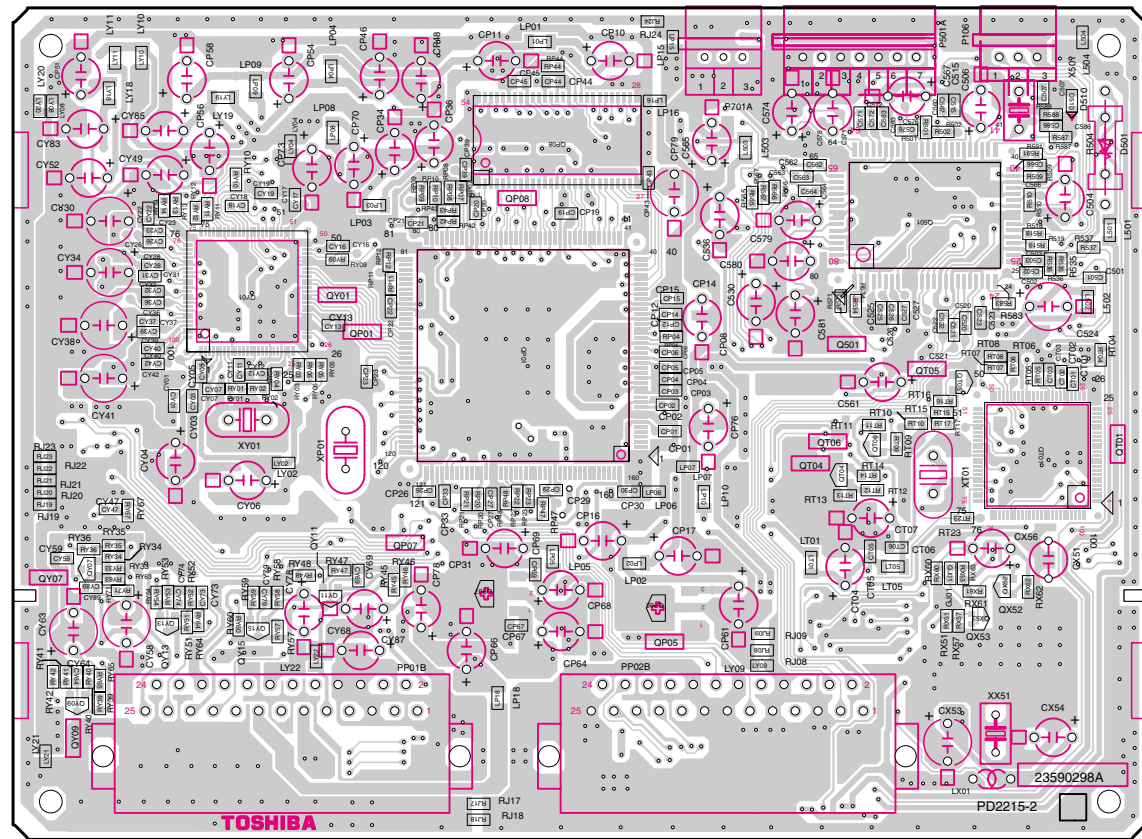

DIGITAL BOARD PD2215-1
BOTTOM (FOIL) SIDE

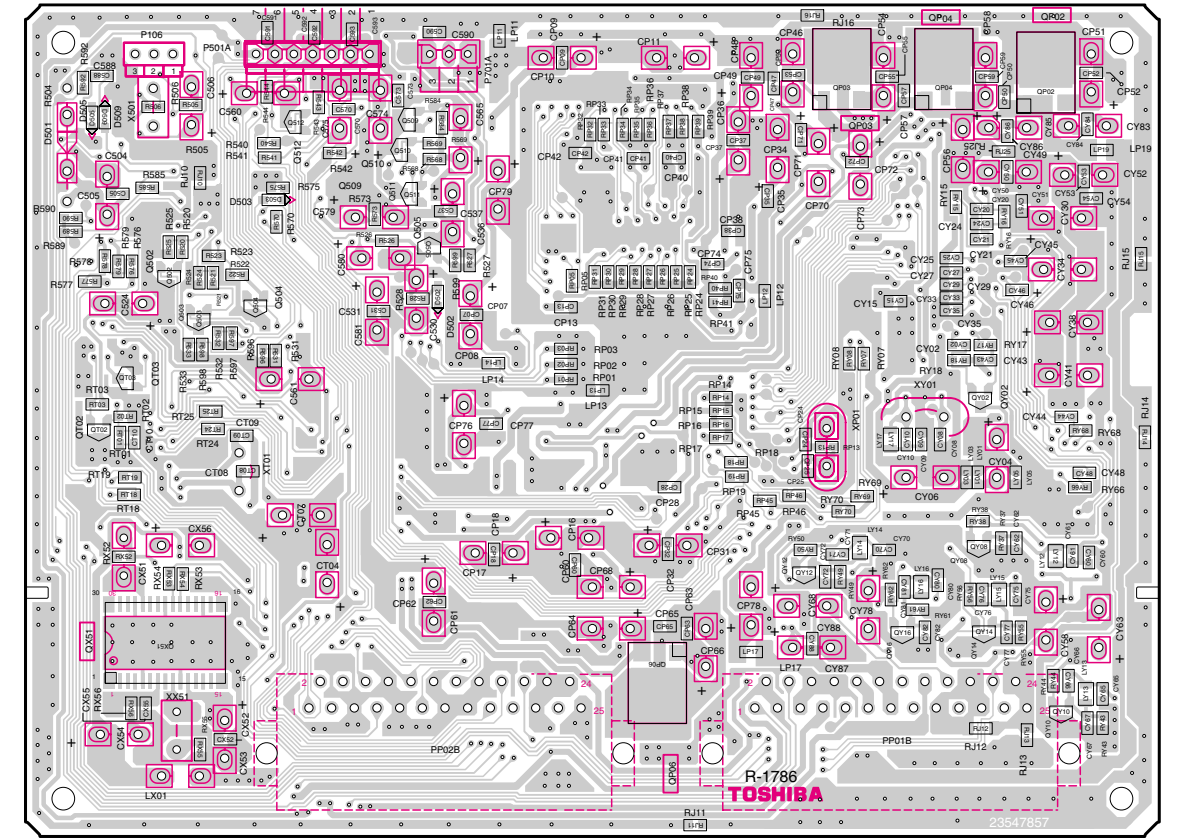

MTS BOARD PD2215-2
TOP (COMPONENT) SIDE

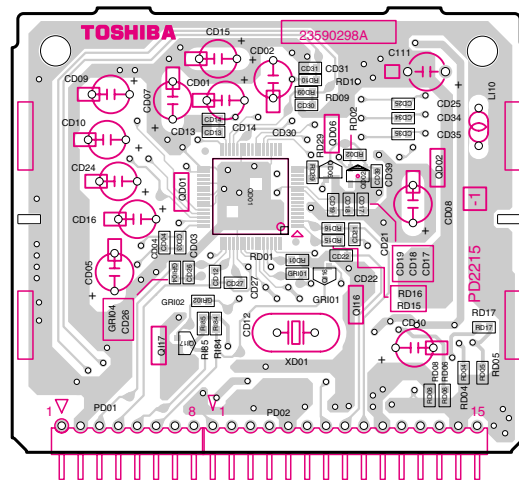

MTS BOARD PD2215-2
BOTTOM (FOIL) SIDE

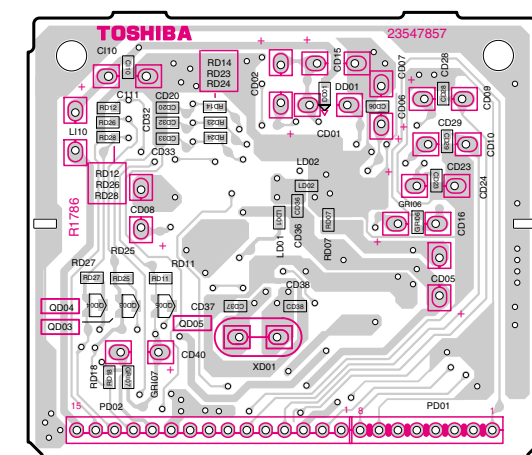

CRT/D BOARD PD2211
BOTTOM (FOIL) SIDE

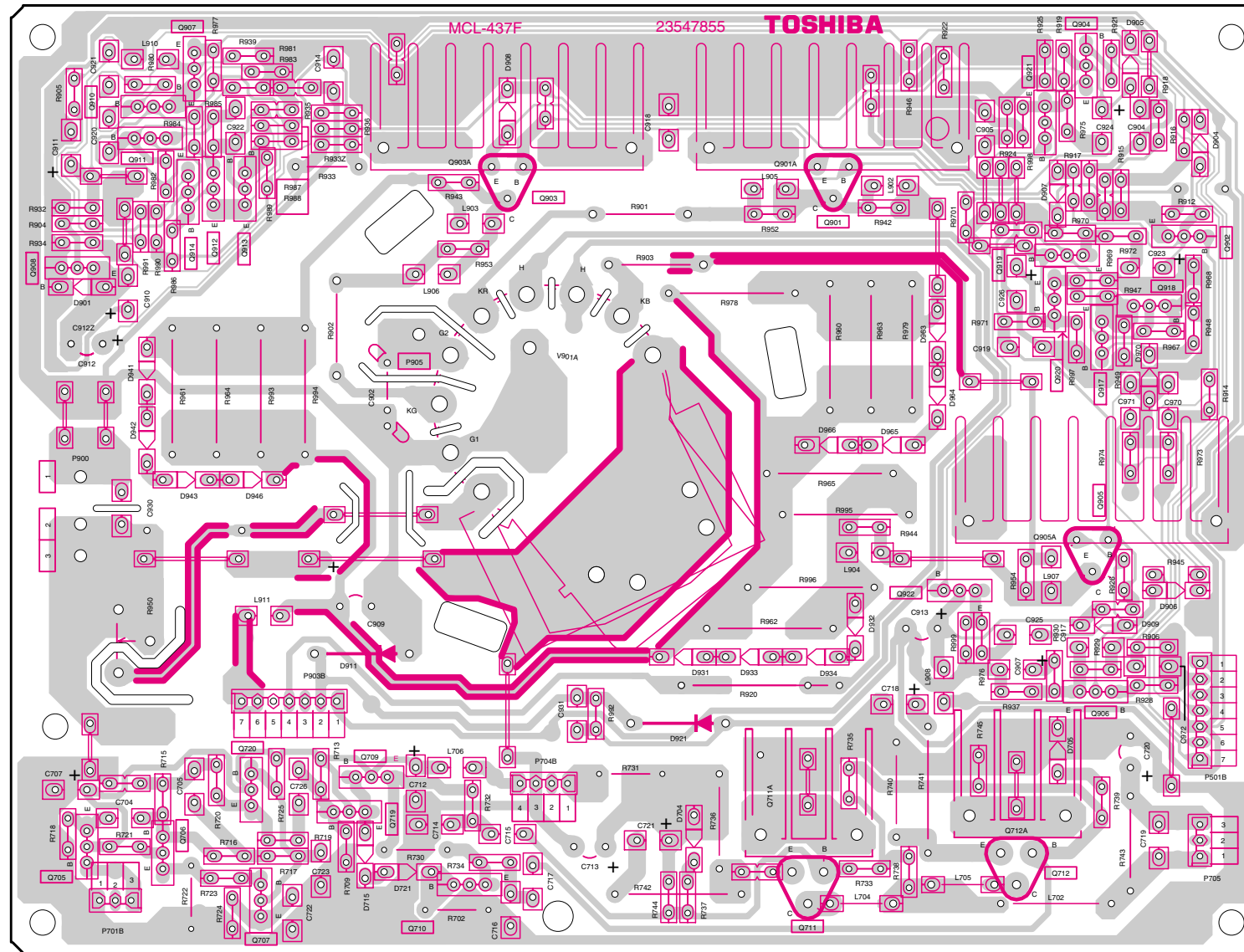

FRONT BOARD PD2216D

BOTTOM (FOIL) SIDE

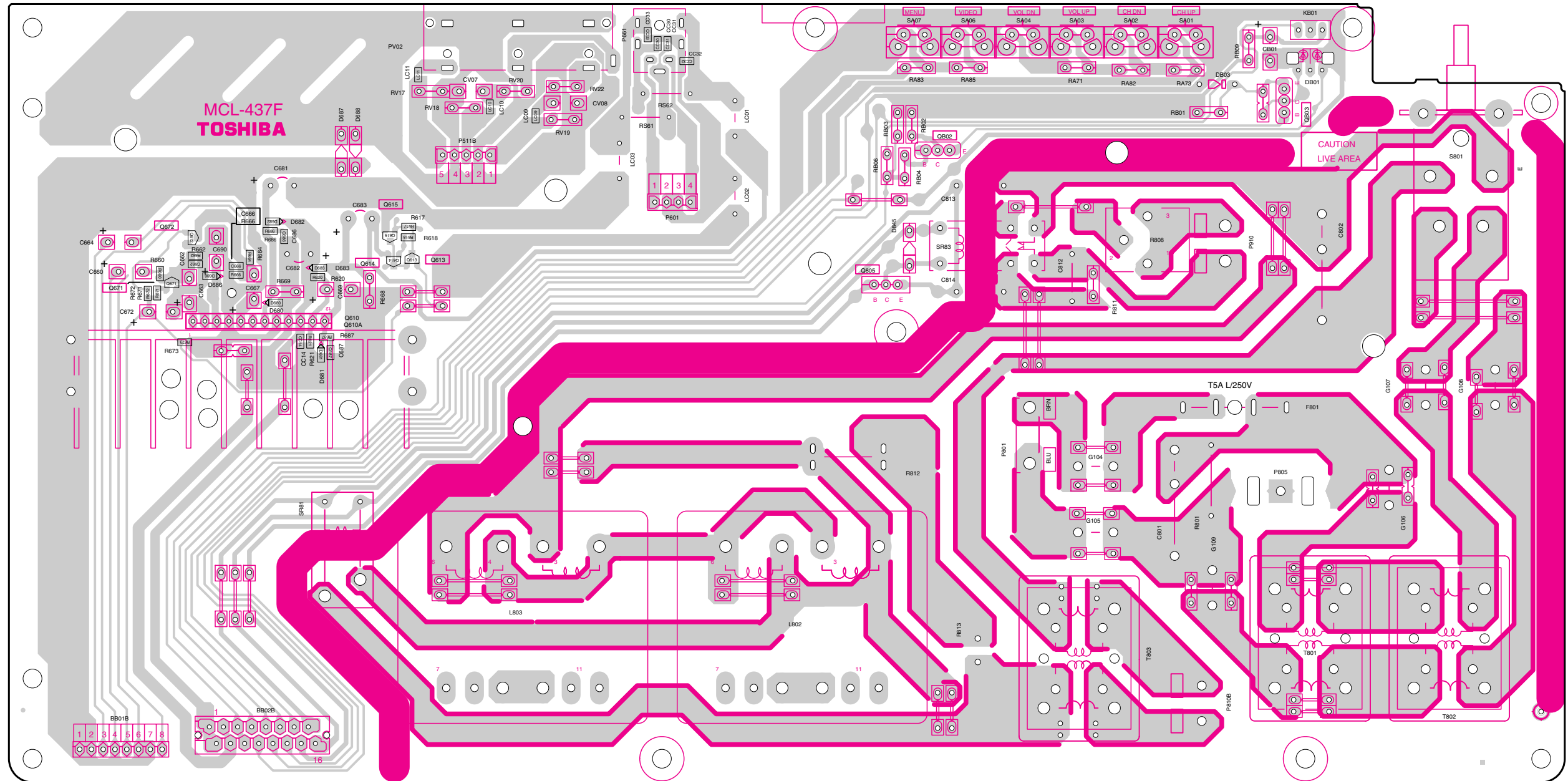

TERMINAL VIEW OF TRANSISTORS

- ① 2SD2253
(old)
2SC5243
2SC5859

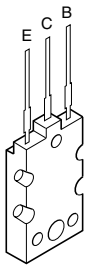

- ② 2SA1186A
2SA1306
2SA1788
2SA1837
2SA1930
2SC1569
2SC3852
2SC4544
2SC4793
2SC5171
2SD1763A
2SD2396

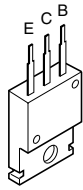

- ③ 2SA1020
2SC2482
2SC2655
2SC4721P
2SC5343
2SC5344
2SC752GTM



- ④ 2SA1015
2SA1320 (F)
2SA2980
2SA562TM
2SA9335
2SC1740S
2SC1815
2SC2120
2SC2878
2SC752
KTA1266
KTC3198

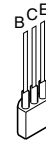

- ⑤ 2SA1788

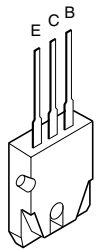

- ⑥ KRC105M
RN1201
RN1202
RN1203
RN1204
RN1205
RN2201
RN2203
RN2204

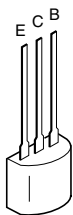

- ⑦ 2SD1554
2SD1556
2SD2253
2SD2396
2SD2553
2SD5143

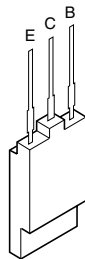

- ⑧ ON4409

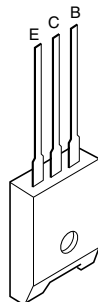



SCHEMATIC DIAGRAM

MODEL : 29CZ8URB/29CZ8URS

WARNING: BEFORE SERVICING THIS CHASSIS, READ THE "X-RAY radiation precaution", "SAFETY PRECAUTION" and "PRODUCT SAFETY NOTICE" ON THE MANUAL FOR THIS MODEL.

CAUTION: The international hazard symbols " \triangle " in the schematic diagram and the parts list designate components which have special characteristics important for safety and should be replaced only with types identical to those in the original circuit or specified in the parts list. The mounting position of replacements is to be identical with originals. Before replacing any of these components, read carefully the PRODUCT SAFETY NOTICE on the MANUAL for this model. Do not degrade the safety of the receiver through improper servicing.

NOTE:

- RESISTOR** Resistance is shown in ohm [K = 1.000, M = 1.000.000]. All resistors are 1/6W and 5% tolerance carbon resistor, unless otherwise noted as the following marks.
1/2R = Metal or Metal oxide of 1/2 watt 1/2S = Carbon composition of 1/2 watt
1RF = Fuse resistor of 1 watt 10W = Cement of 10 watt
K = $\pm 10\%$ G = $\pm 2\%$ F = $\pm 1\%$
- CAPACITOR** Unless otherwise noted in schematic, all capacitor values less than 1 are expressed in μF , and the values more than 1 in pF.
All capacitors are ceramic 50V, unless otherwise noted as the following marks.
 Electrolytic capacitor  Mylar capacitor
- The parts indicated with " \triangle " have special characteristics, and should be replaced with identical parts only.
- Voltages read with DIGITAL MULTI-METER from point indicated to chassing ground, using a color bar signal with all controls at normal, line voltage at 220 volts.
- Waveforms are taken receiving color bar signal with enough sensitivity.
- Voltage reading shown are nominal values and may vary $\pm 20\%$ except H.V.

■ SCHEMATIC DIAGRAM STRUCTURE:

MAIN Circuit	1/6
DIGITAL Circuit	2/6
MTS Circuit	3/6
CRT/D Circuit	4/6
FRONT AV-1 Circuit	5/6
FRONT AV-2 Circuit	6/6

CIRCUIT BLOCK DIAGRAM

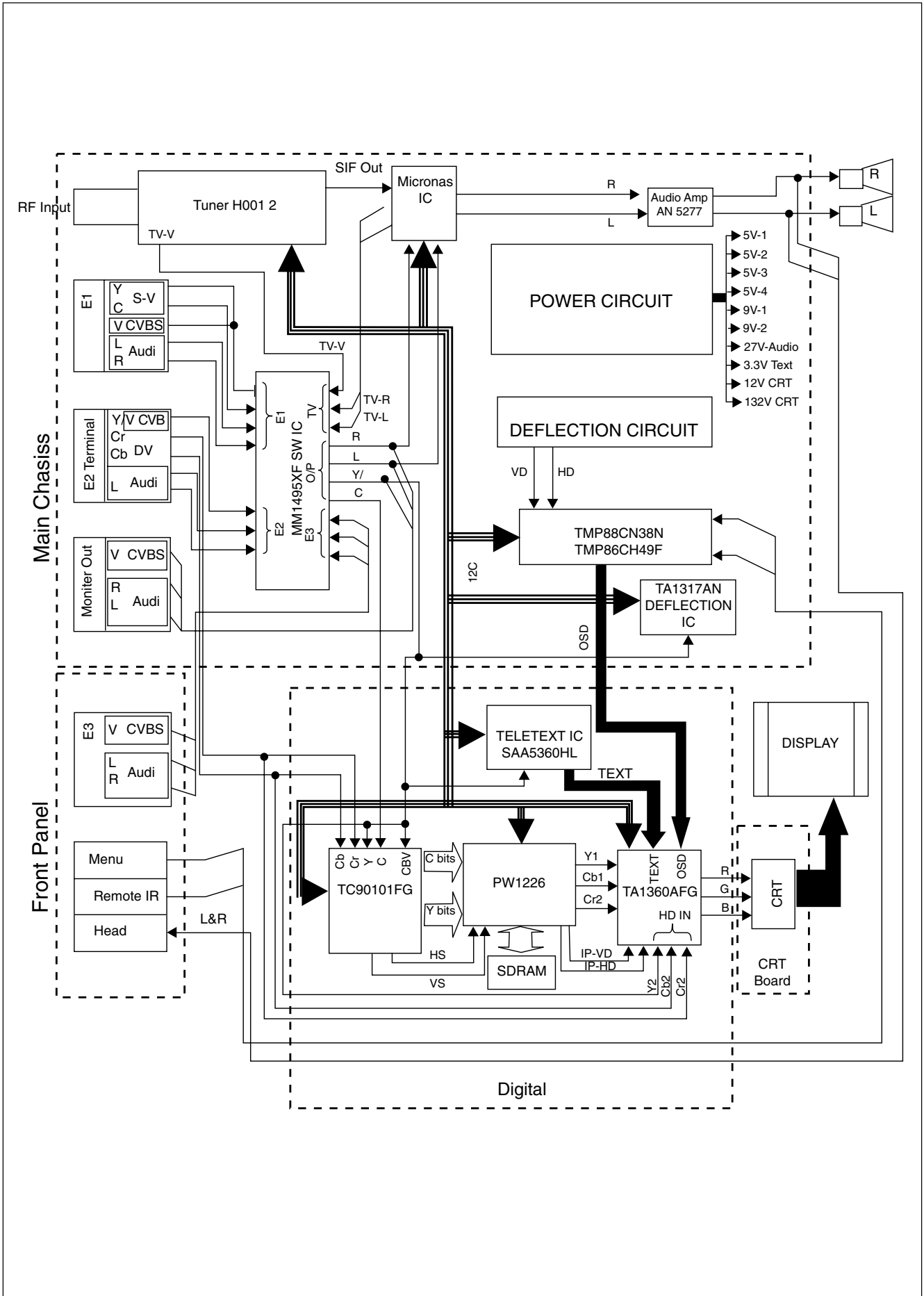

SPECIFICATIONS

MODEL		29CZ8URB/29CZ8URS				
Rated voltage		~ 220 V – 240 V, 50 Hz				
Power consumption (at ~ 220 V, 50 Hz)		170 W				
Dimensions (Width × Depth × Height)		782.1(W) × 492.5(D) × 585.1(H) mm				
Mass		44 kg				
Picture tube		Type 29 Flat super crystal picture tube (727.4mm) Overall picture tube measured diagonally (676mm) Viewable picture tube measured diagonally 104° deflection				
Television system (Aerial input)	Channel coverage	System	Channel	VHF	UHF	CATV (Channels)
	Special RF signal	Color system NTSC4.43, PAL 60Hz Sound system 5.5/6.0/6.5 MHz				
COMPONENT VIDEO INPUT terminals (signal format)		480i, 480p, 576i, 576p (These signal formats are converted to match the peculiar scanning system)				
Color system		PAL/SECAM/NTSC4.43/NTSC3.58				
Sound output		10 W × 2				
Speaker		6 × 12cm (2)				
Terminals		Input [⊖(1)] : S-Video/Video, Audio L/MONO, Audio R Input [⊖(2)/DVD] : Video/Y, P _B /C _B /P _R /C _R , Audio L/MONO, Audio R Input [⊖(3)] : Video, Audio L/MONO, Audio R Output [⊕(MONITOR)] : Video, Audio L/MONO, Audio R Headphone output : ø 3.5mm (mini jack stereo type)				

* Please refer to owner's manual in details.

TOSHIBA SINGAPORE PTE LTD



SCHEMATIC DIAGRAM

MODEL : 29CZ8URB/29CZ8URS

WARNING: BEFORE SERVICING THIS CHASSIS, READ THE "X-RAY radiation precaution", "SAFETY PRECAUTION" and "PRODUCT SAFETY NOTICE" ON THE MANUAL FOR THIS MODEL.

CAUTION: The international hazard symbols " \triangle " in the schematic diagram and the parts list designate components which have special characteristics important for safety and should be replaced only with types identical to those in the original circuit or specified in the parts list. The mounting position of replacements is to be identical with originals. Before replacing any of these components, read carefully the PRODUCT SAFETY NOTICE on the MANUAL for this model. Do not degrade the safety of the receiver through improper servicing.

NOTE:

1. RESISTOR Resistance is shown in ohm [K = 1.000, M = 1.000.000]. All resistors are 1/6W and 5% tolerance carbon resistor, unless otherwise noted as the following marks.
1/2R = Metal or Metal oxide of 1/2 watt 1/2S = Carbon composition of 1/2 watt
1RF = Fuse resistor of 1 watt 10W = Cement of 10 watt
K = $\pm 10\%$ G = $\pm 2\%$ F = $\pm 1\%$
2. CAPACITOR Unless otherwise noted in schematic, all capacitor values less than 1 are expressed in μF , and the values more than 1 in pF.
All capacitors are ceramic 50V, unless otherwise noted as the following marks.
 Electrolytic capacitor  Mylar capacitor
3. The parts indicated with " \triangle " have special characteristics, and should be replaced with identical parts only.
4. Voltages read with DIGITAL MULTI-METER from point indicated to chassing ground, using a color bar signal with all controls at normal, line voltage at 220 volts.
5. Waveforms are taken receiving color bar signal with enough sensitivity.
6. Voltage reading shown are nominal values and may vary $\pm 20\%$ except H.V.

■ SCHEMATIC DIAGRAM STRUCTURE:

MAIN Circuit	1/6
DIGITAL Circuit	2/6
MTS Circuit	3/6
CRT/D Circuit	4/6
FRONT AV-1 Circuit	5/6
FRONT AV-2 Circuit	6/6

CIRCUIT BLOCK DIAGRAM

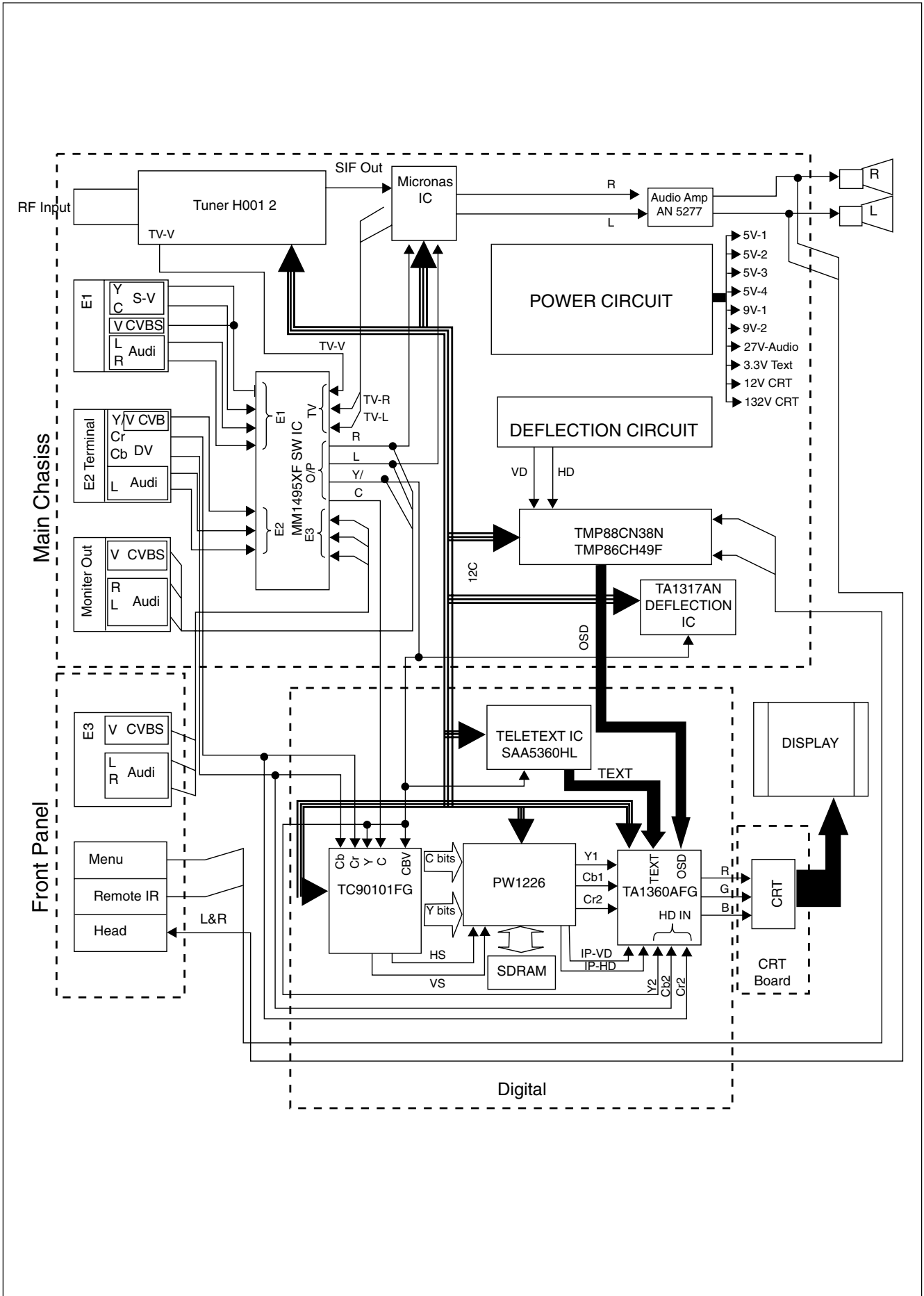

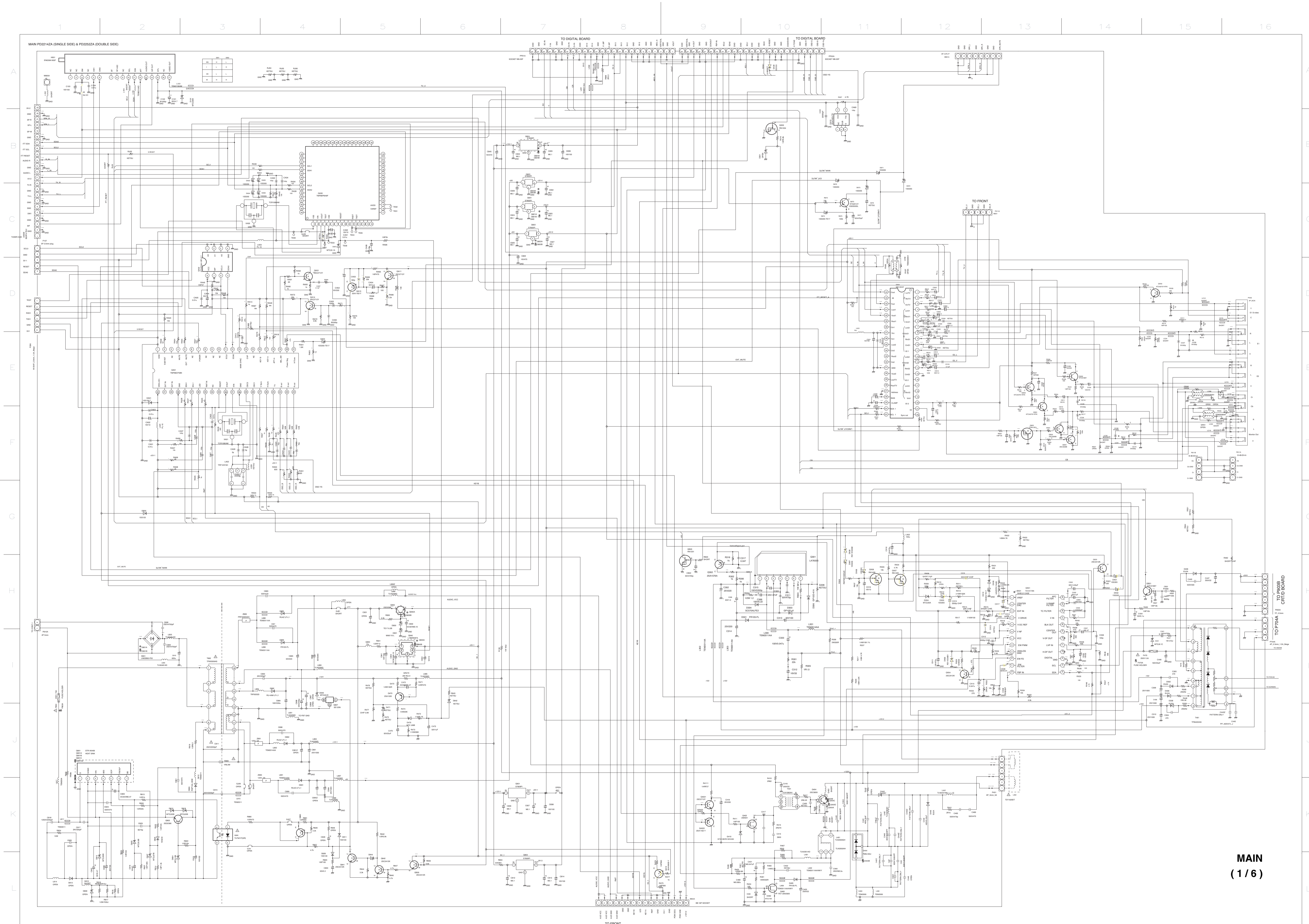

SCHEMATIC DIAGRAM

MODEL : 29CZ8URB/29CZ8URS

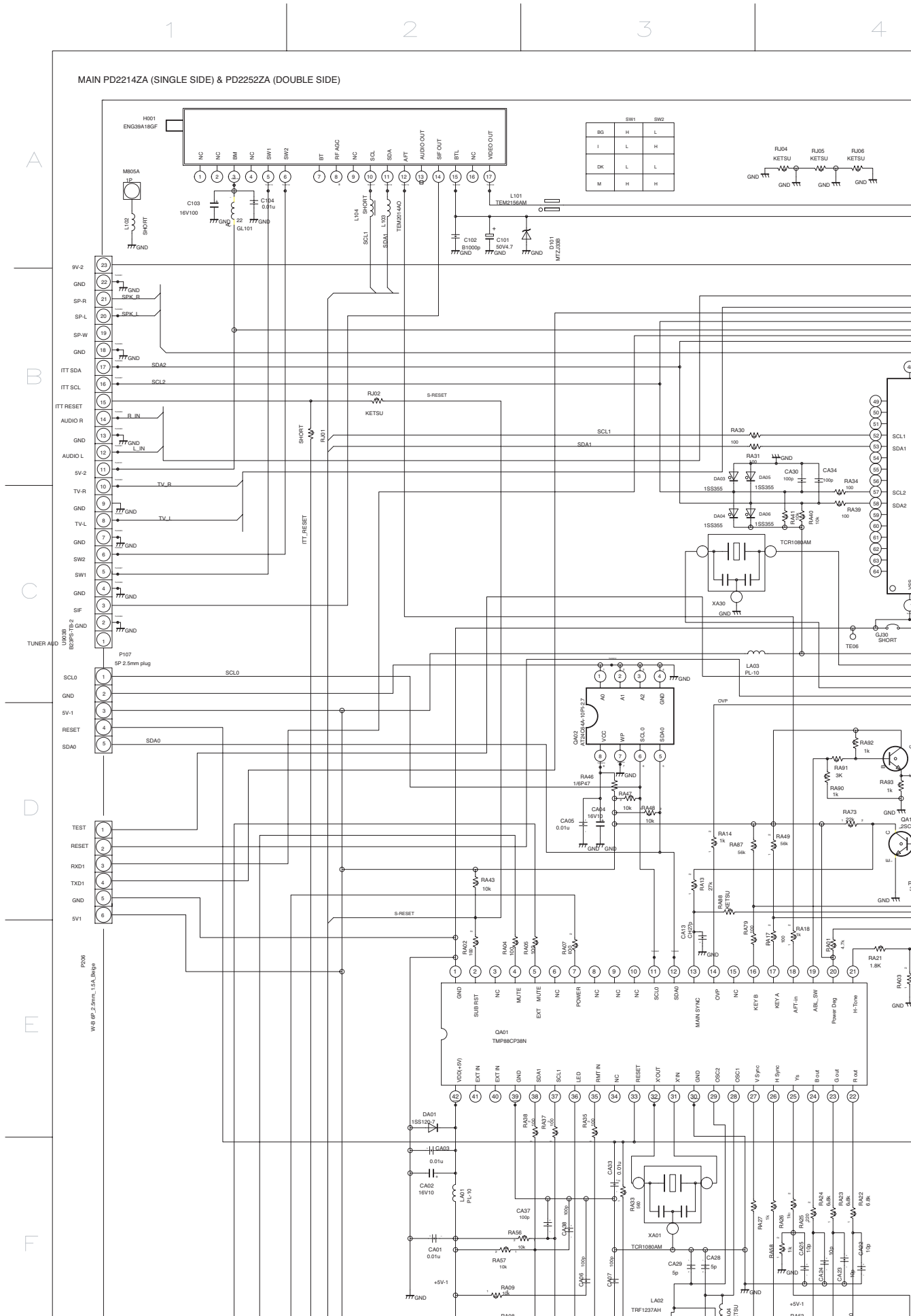

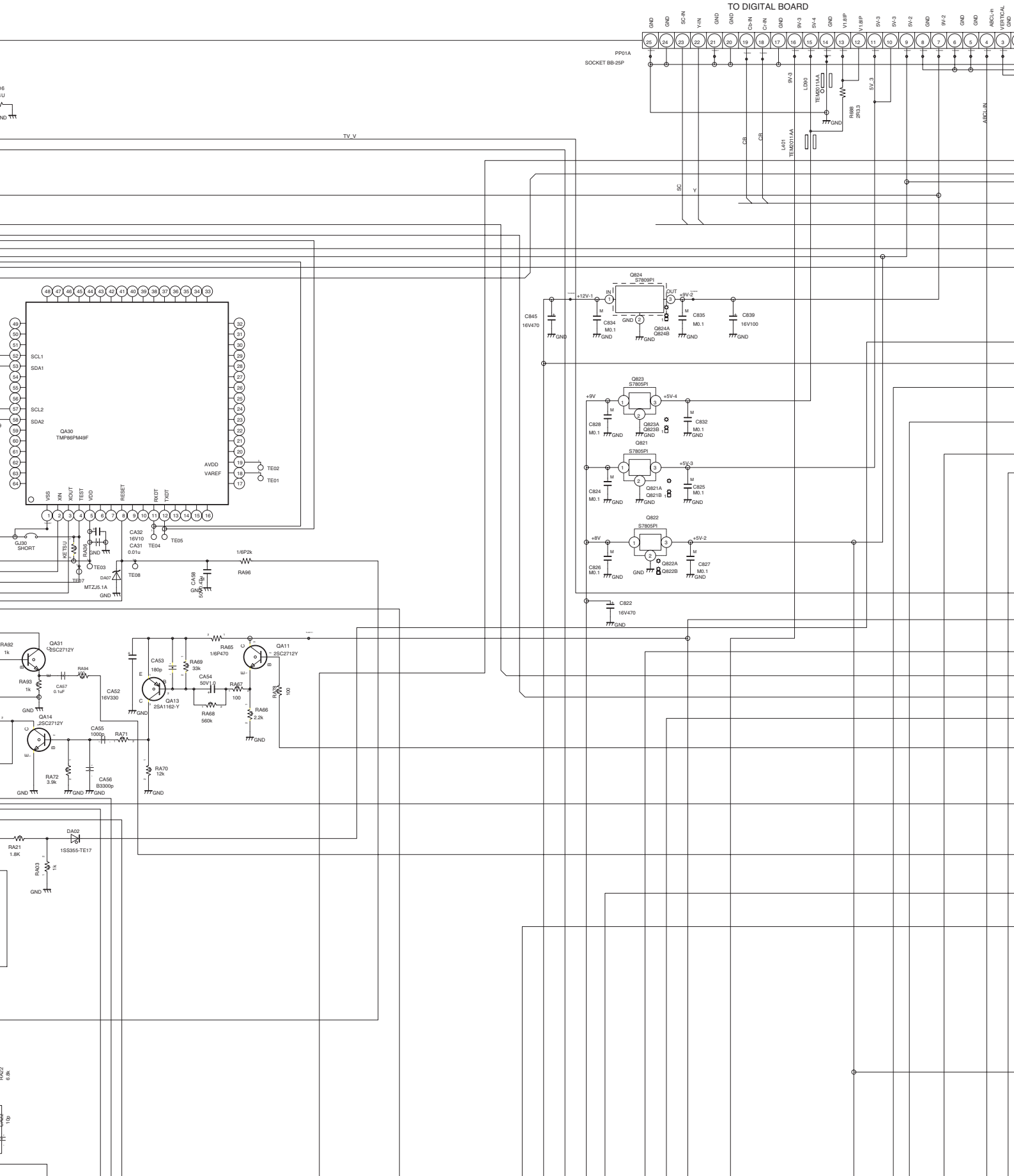

9

10

11

12

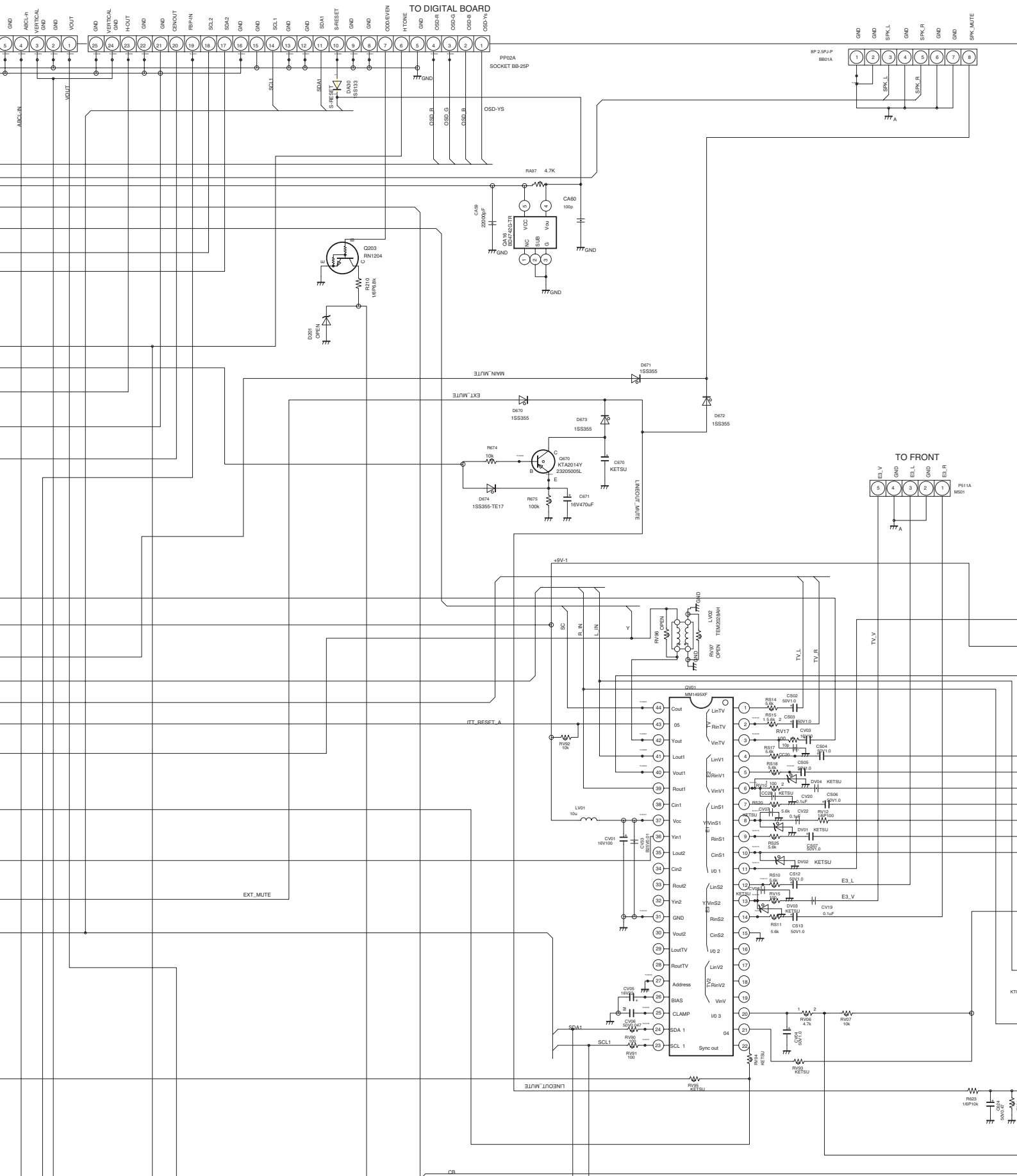

13

14

15

16

A

B

C

D

E

F

SPK_AUITE

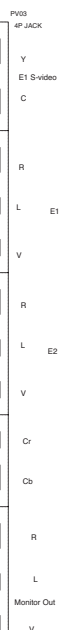
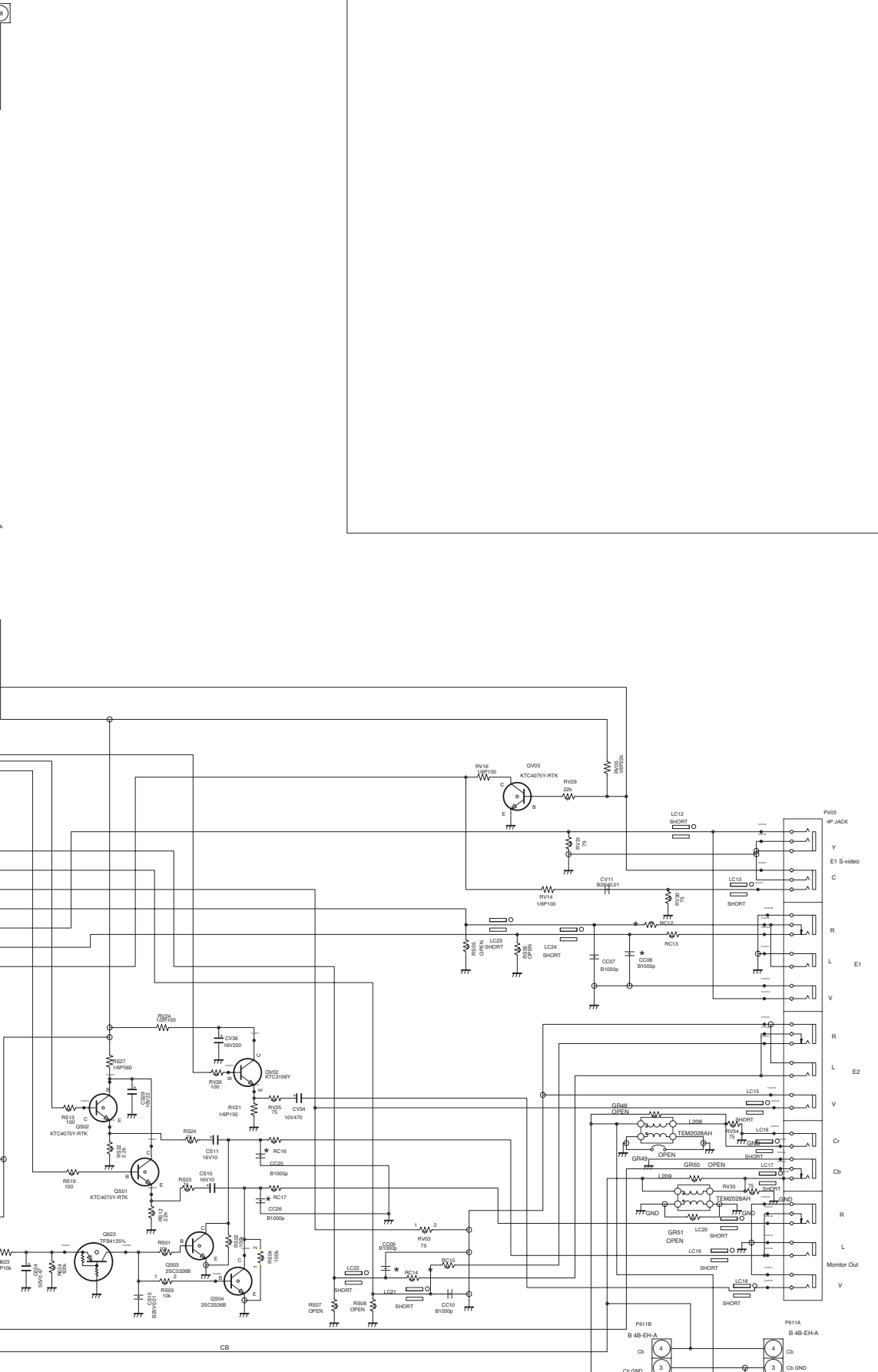

CB

CS

CS GND

CS

CS GND

CS

CS GND

CS

CS GND

CS

CS GND

CS

CS GND

CS

CS GND

CS

CS GND

CS

CS GND

CS

CS GND

CS

G
H
I
J
K
L

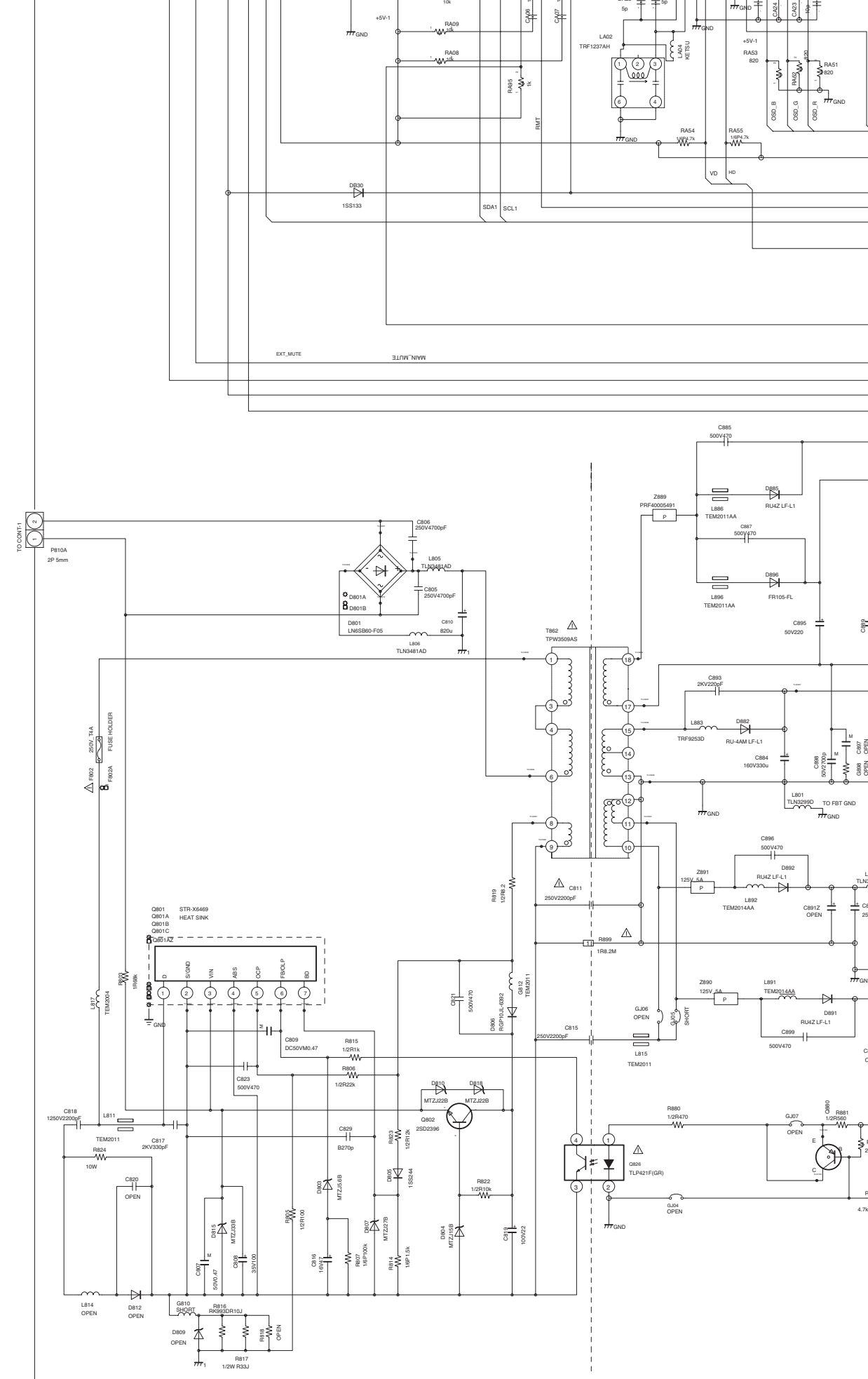

1 2 3 4

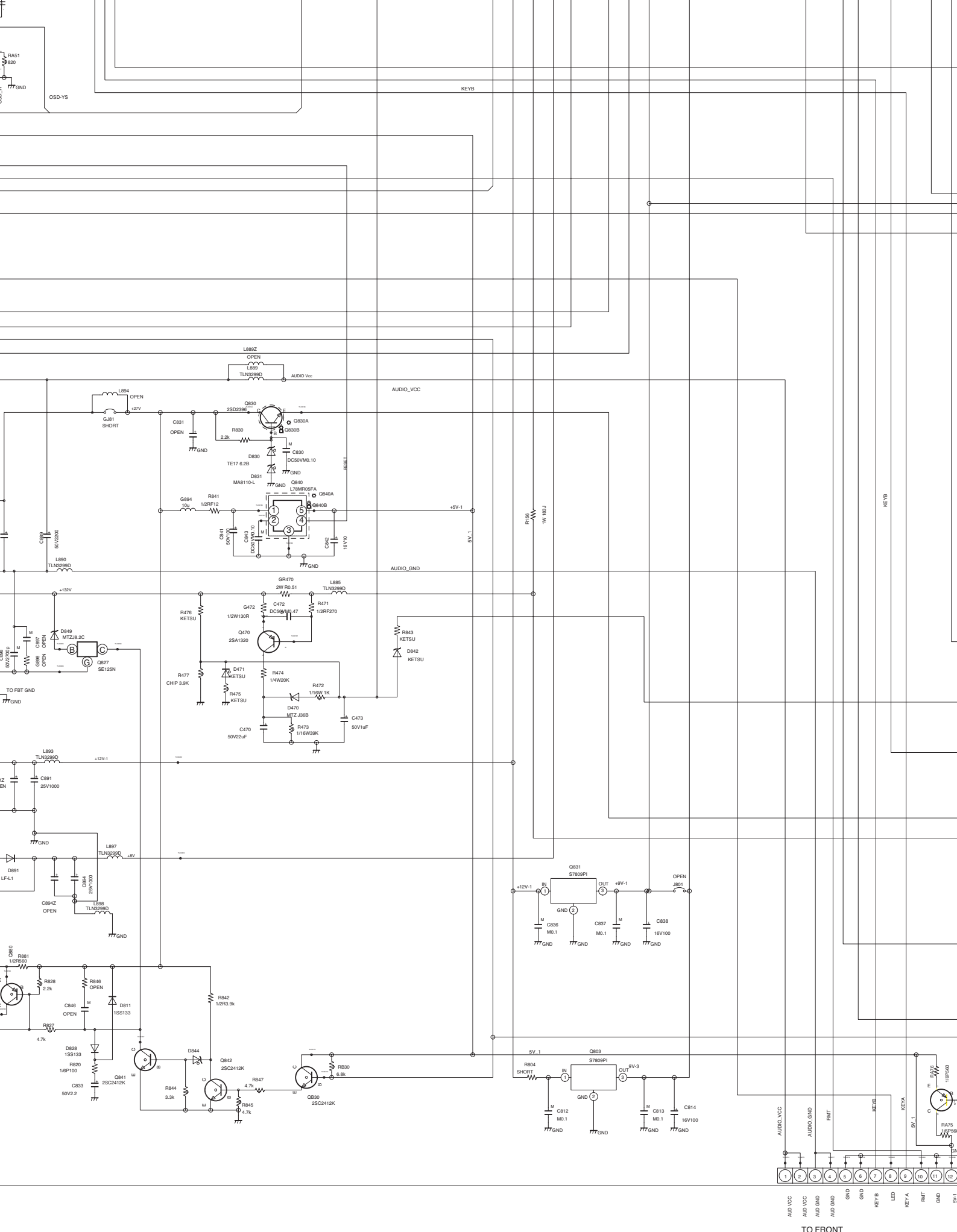

4

5

6

7

8

TO FRONT

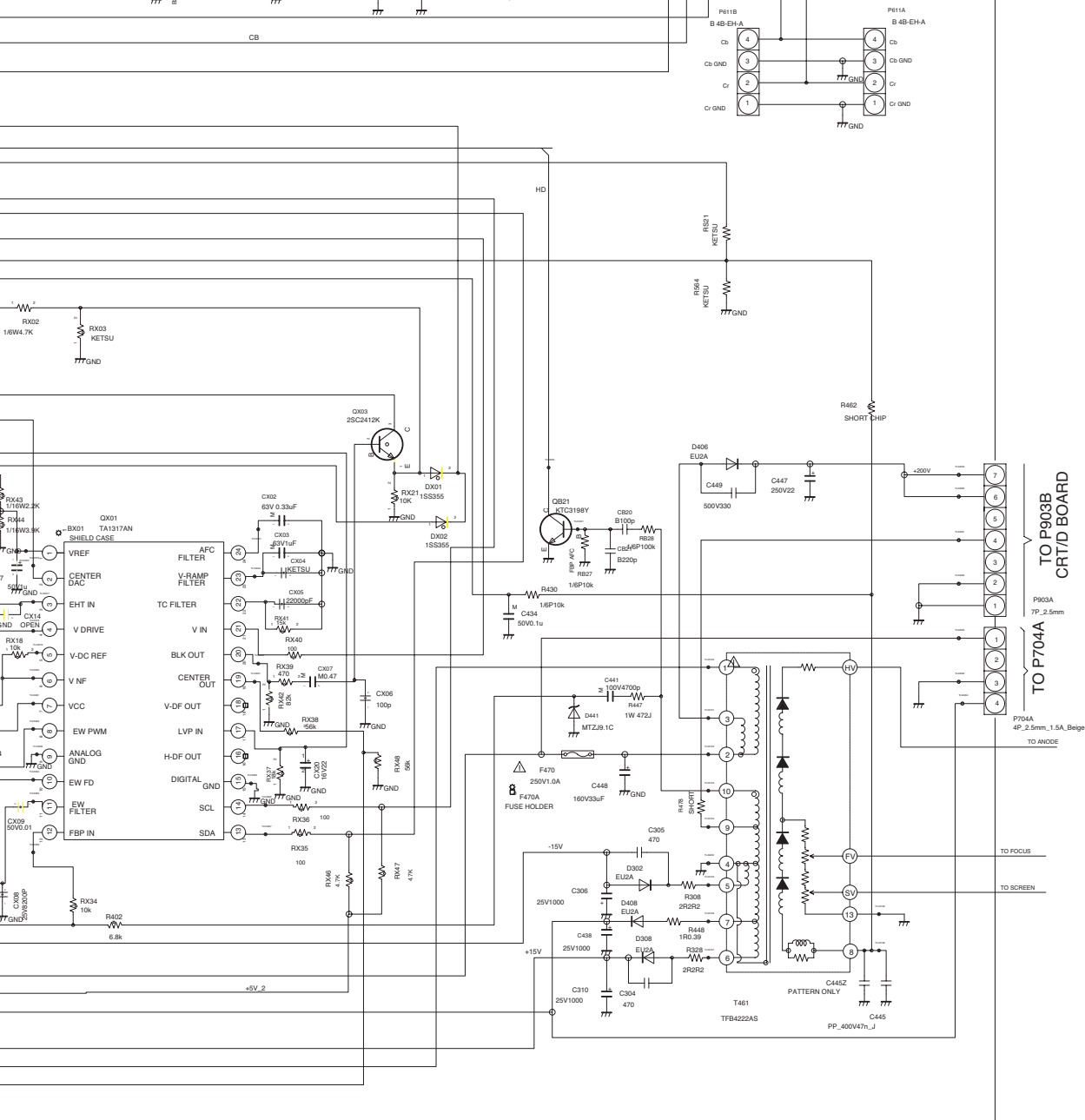

**MAIN
(1/6)**

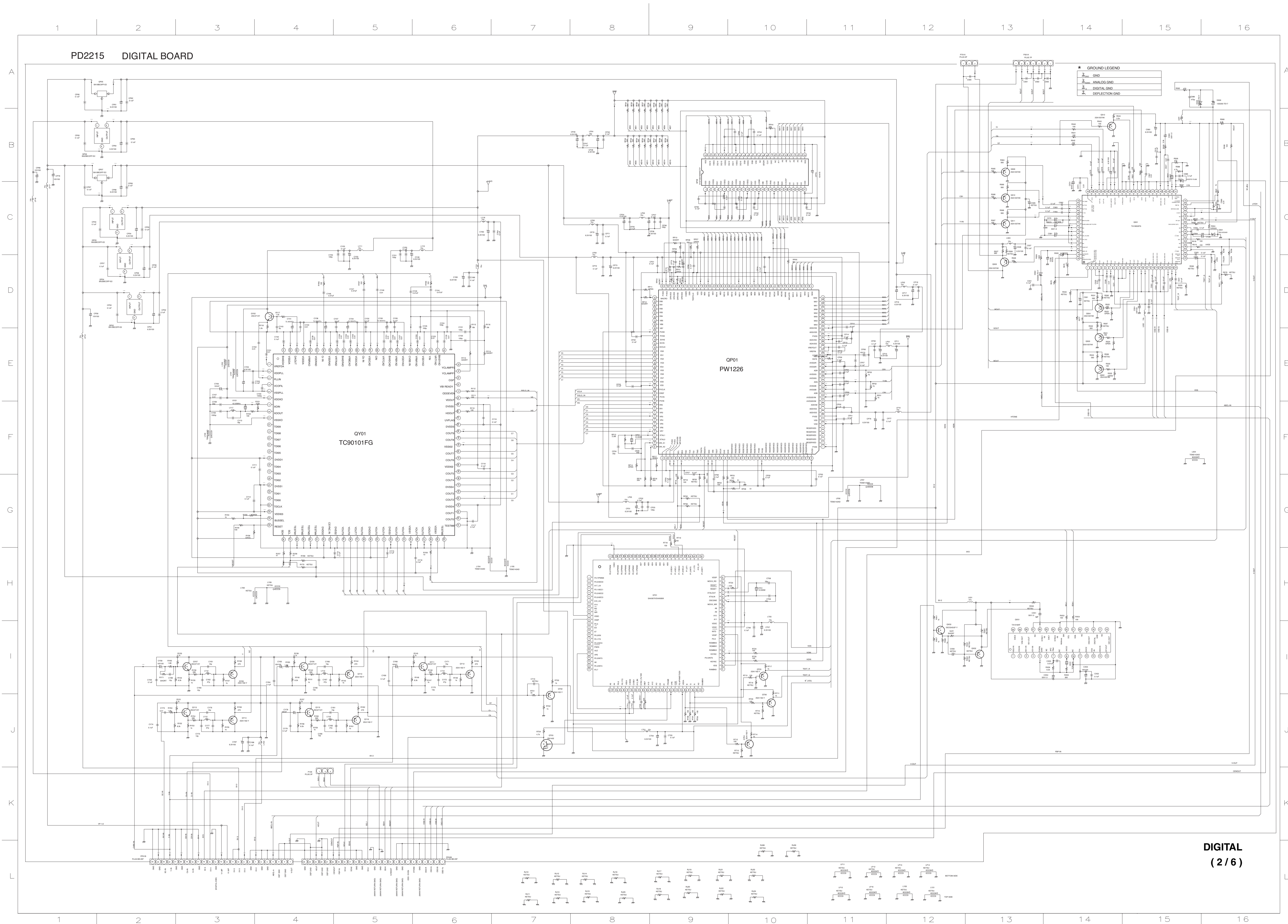

SCHEMATIC DIAGRAM MODEL : 29CZ8URB/29CZ8URS

1

2

3

4

PD2215 DIGITAL BOARD

A

B

C

D

E

F

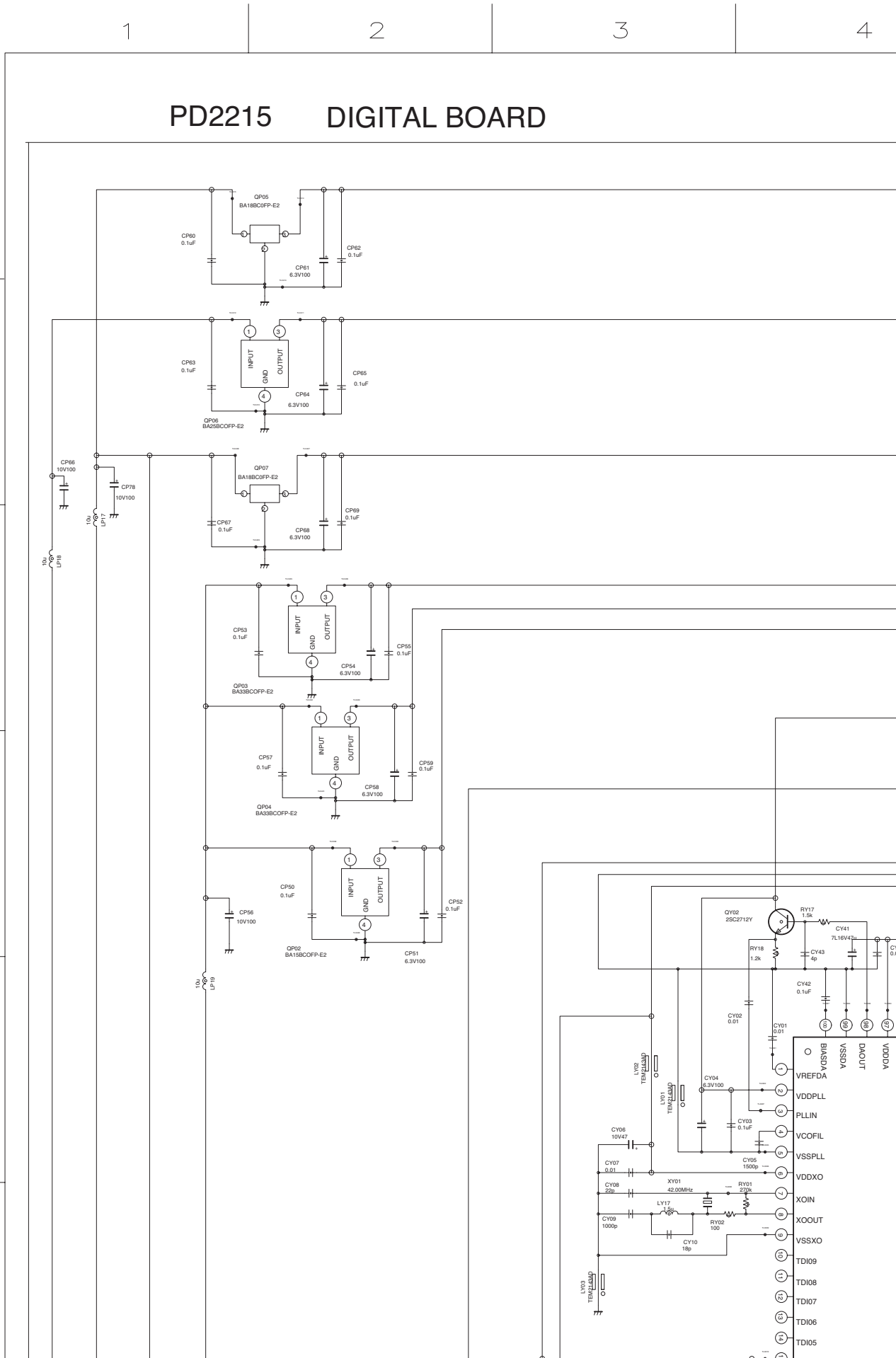

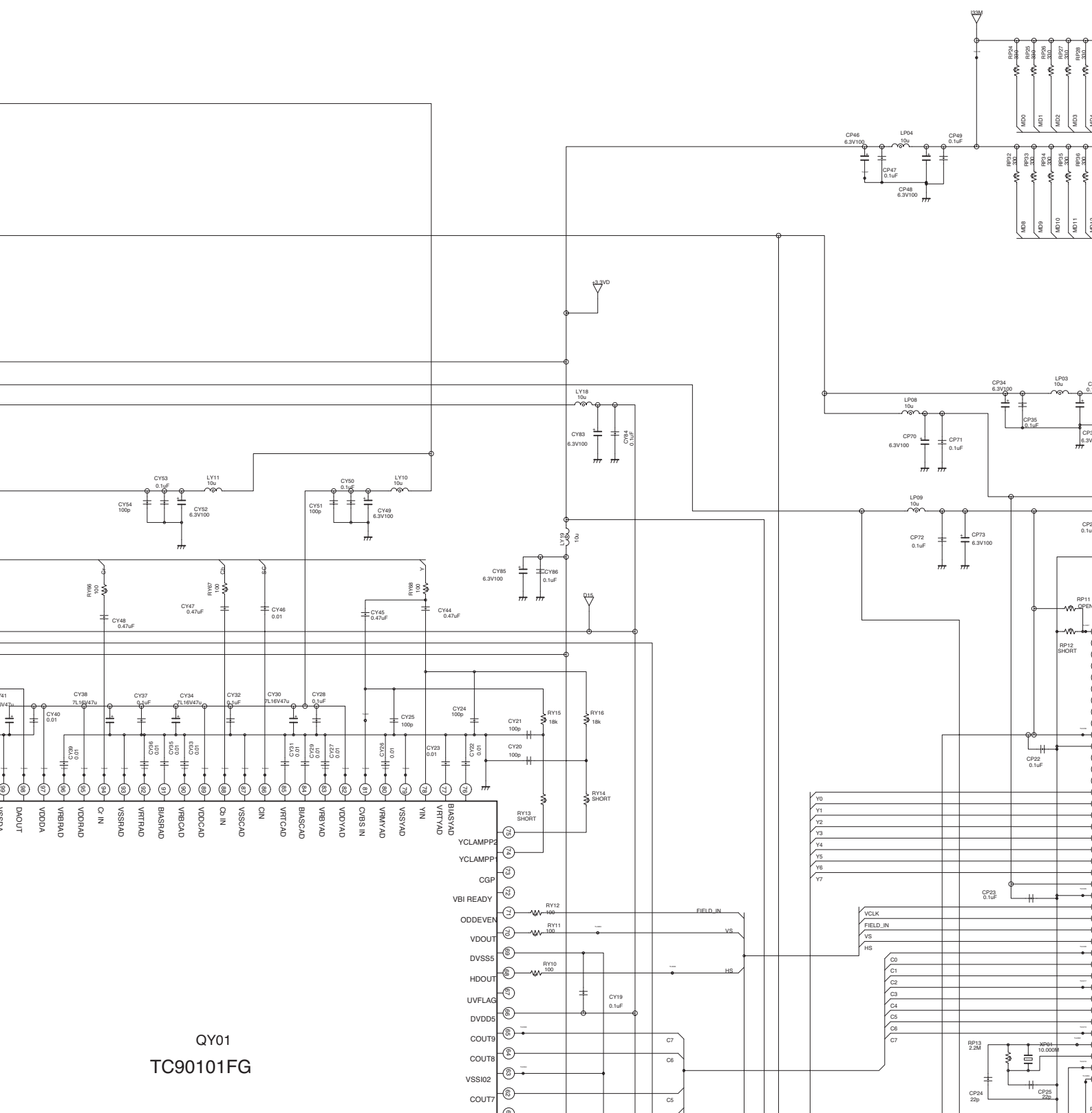

QY01
TC90101FG

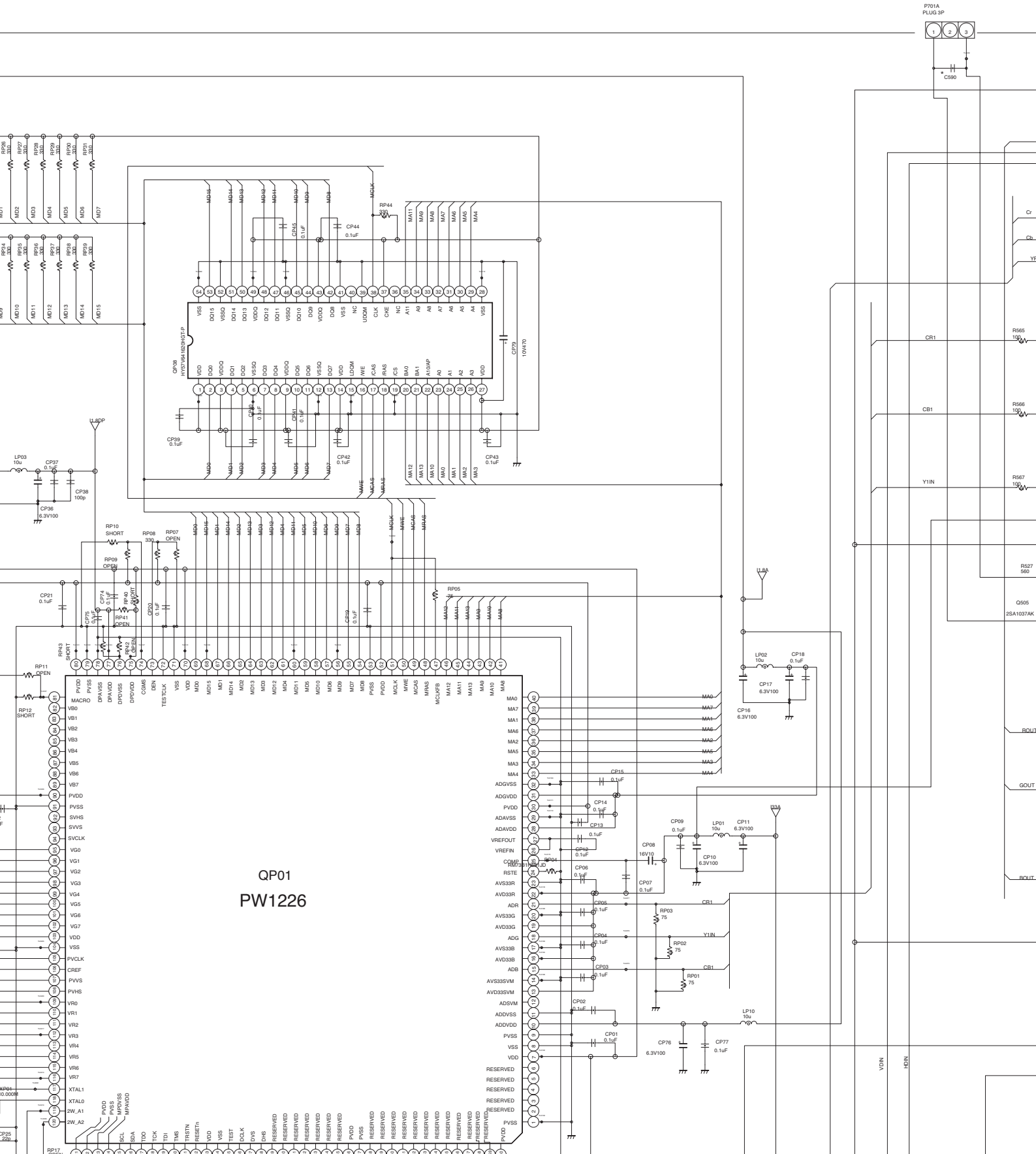

A

B

C

D

E

F

F501A
PLUG 7P

* GROUND LEGEND

	GND
	ANALOG GND
	DIGITAL GND
	DEFLECTION GND

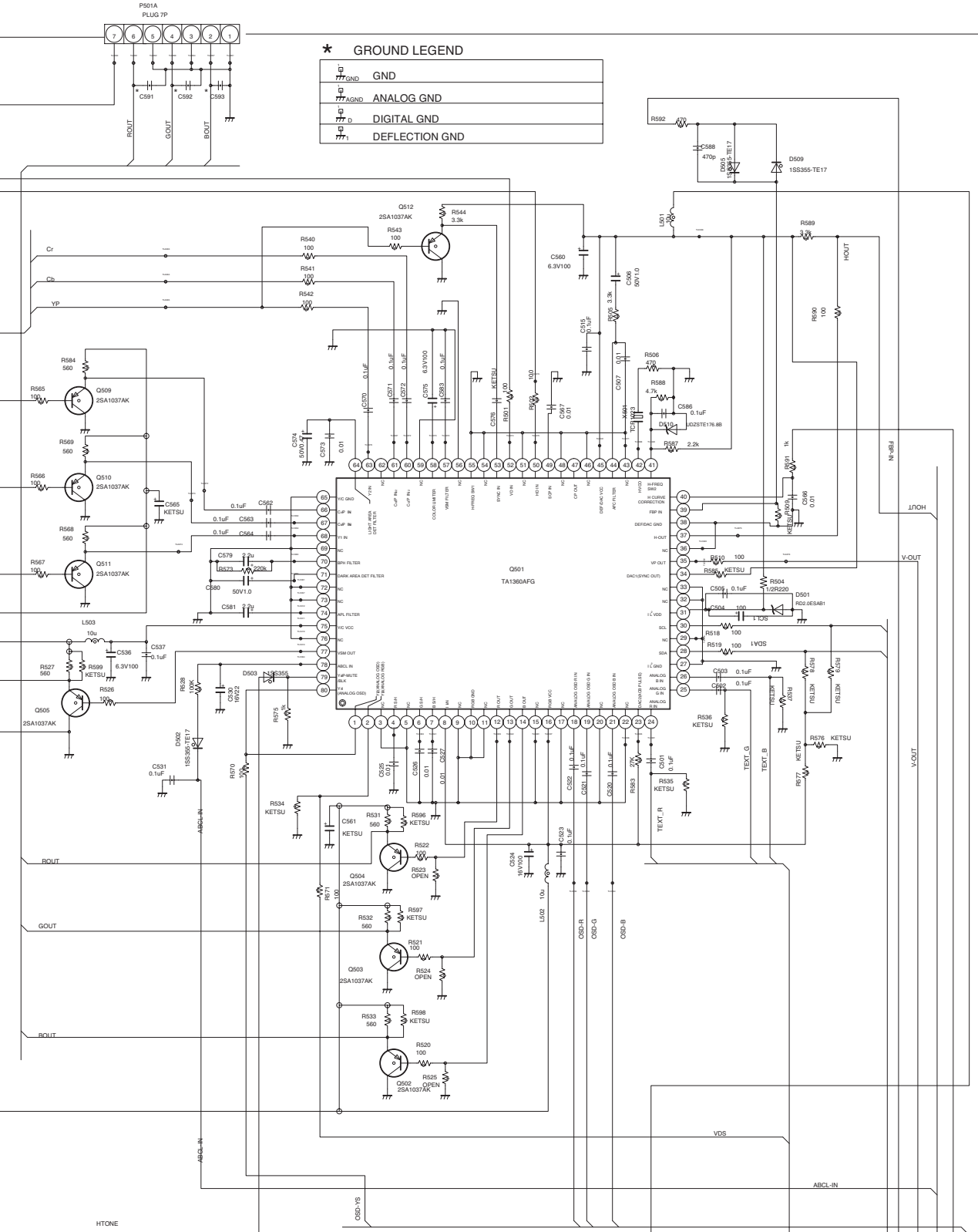

G

H

I

J

K

L

1

2

3

4

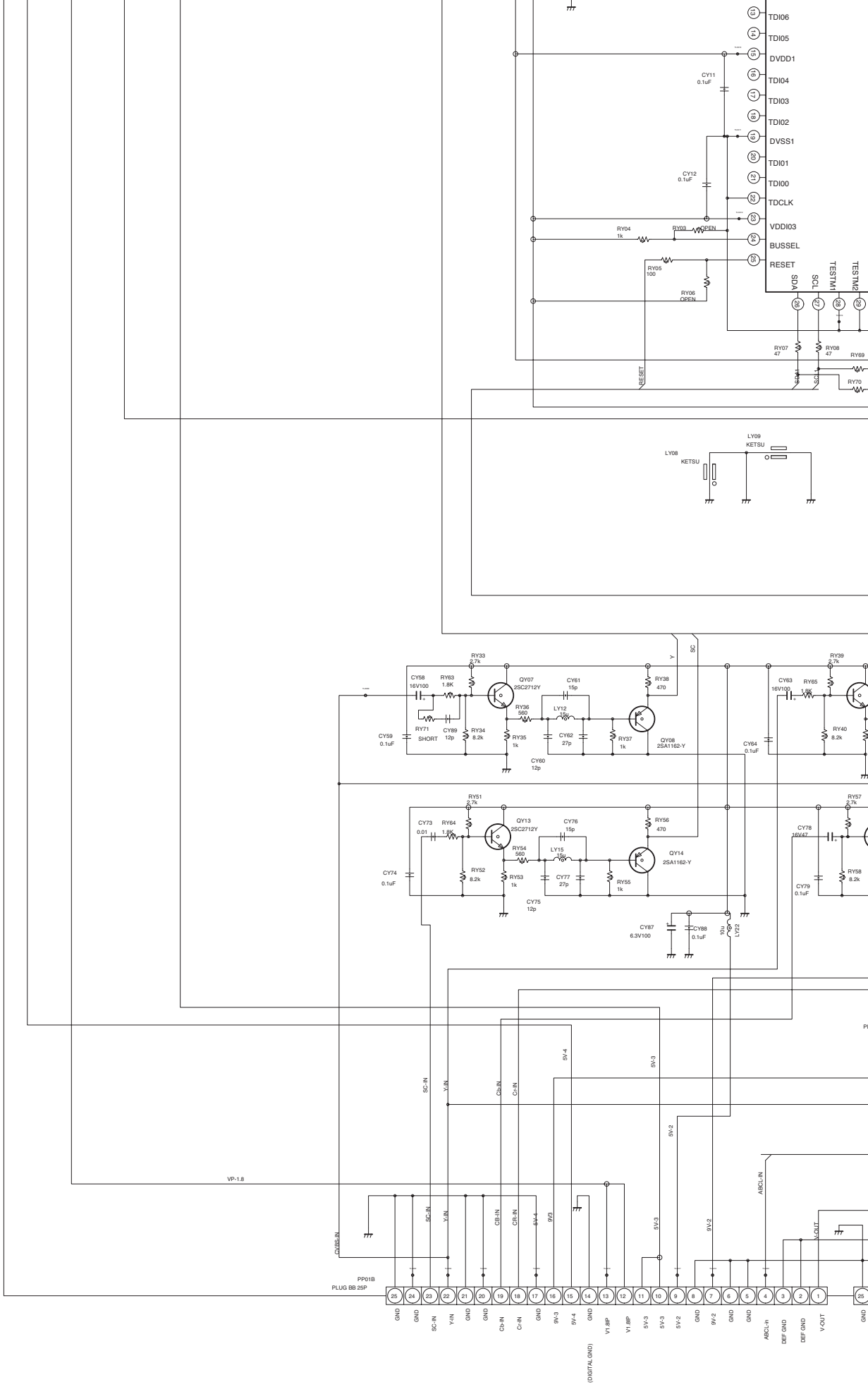

1

2

3

4

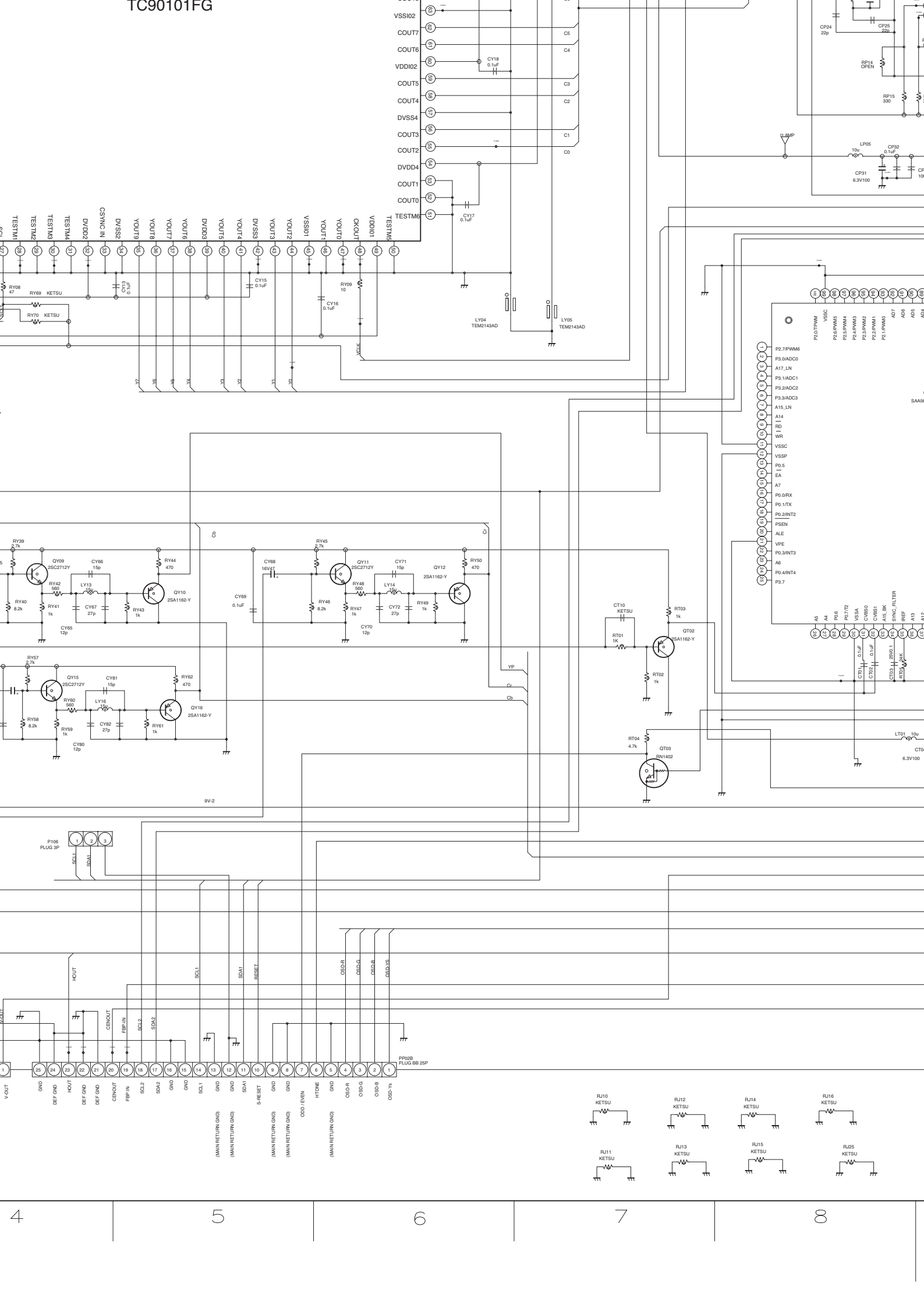

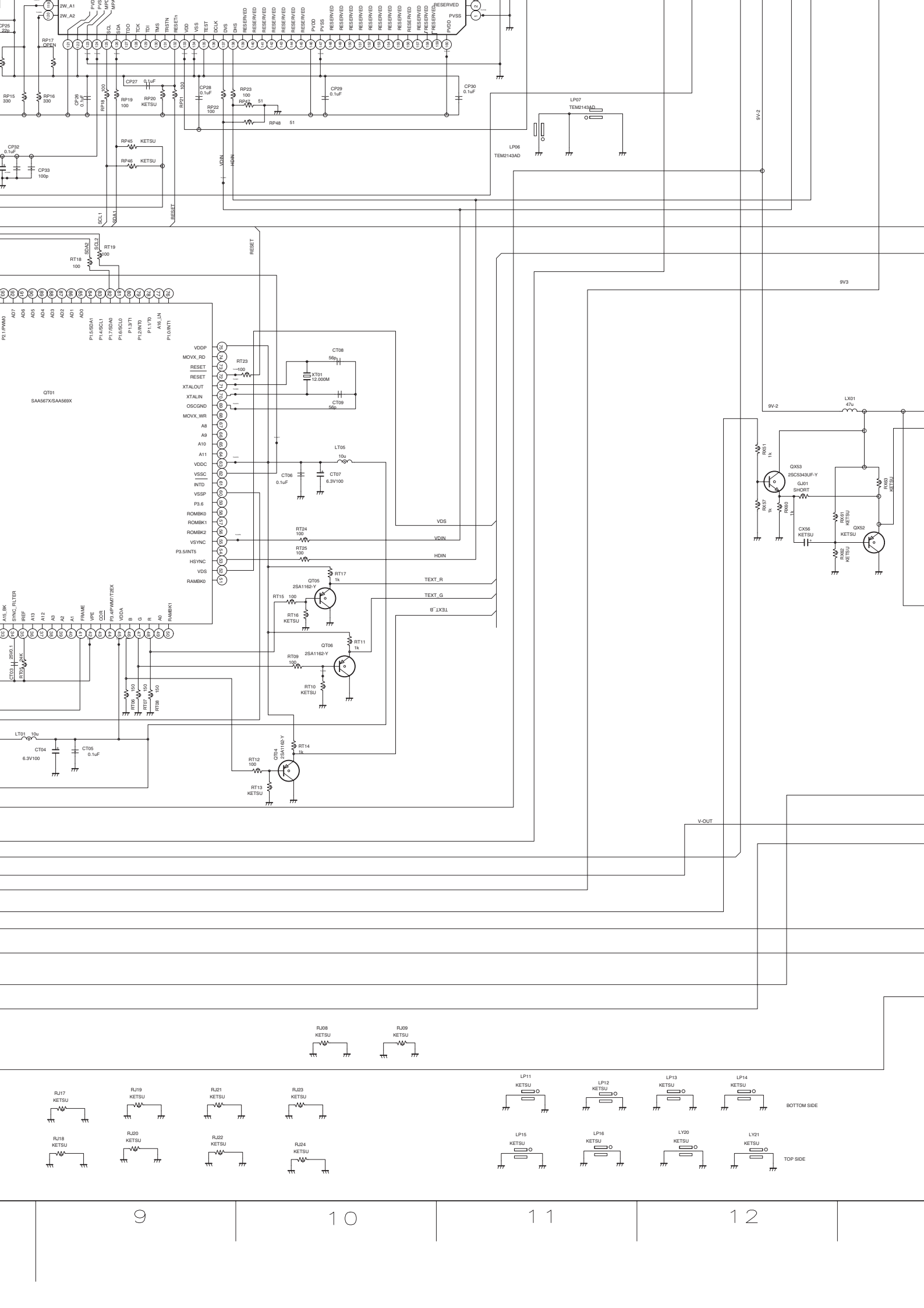

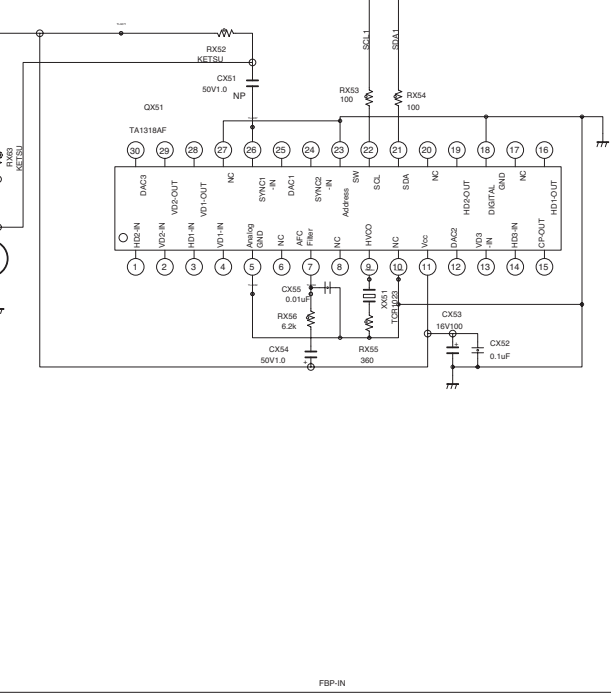
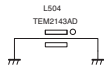

DIGITAL
(2 / 6)

G

H

I

J

K

L

13

14

15

16

SCHEMATIC DIAGRAM MODEL : 29CZ8URB/29CZ8URS

1

2

3

4

5

6

7

8

A

B

C

D

E

F

A

B

C

D

E

F

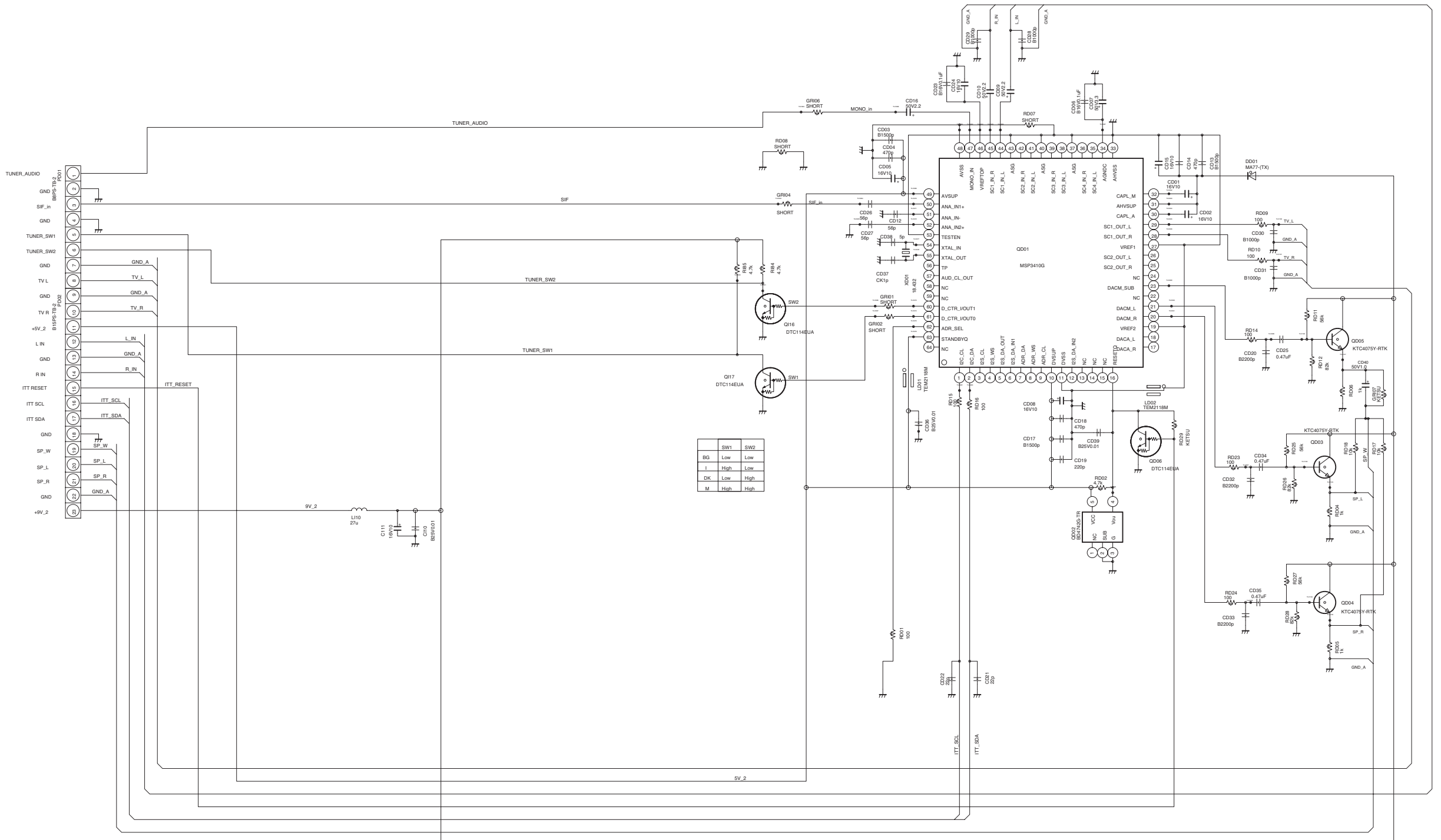

1

2

3

4

5

6

7

8

1 2 3 4 5 6 7 8 9 10 11 12

A

B

C

D

E

F

G

H

A

B

C

D

E

F

G

H

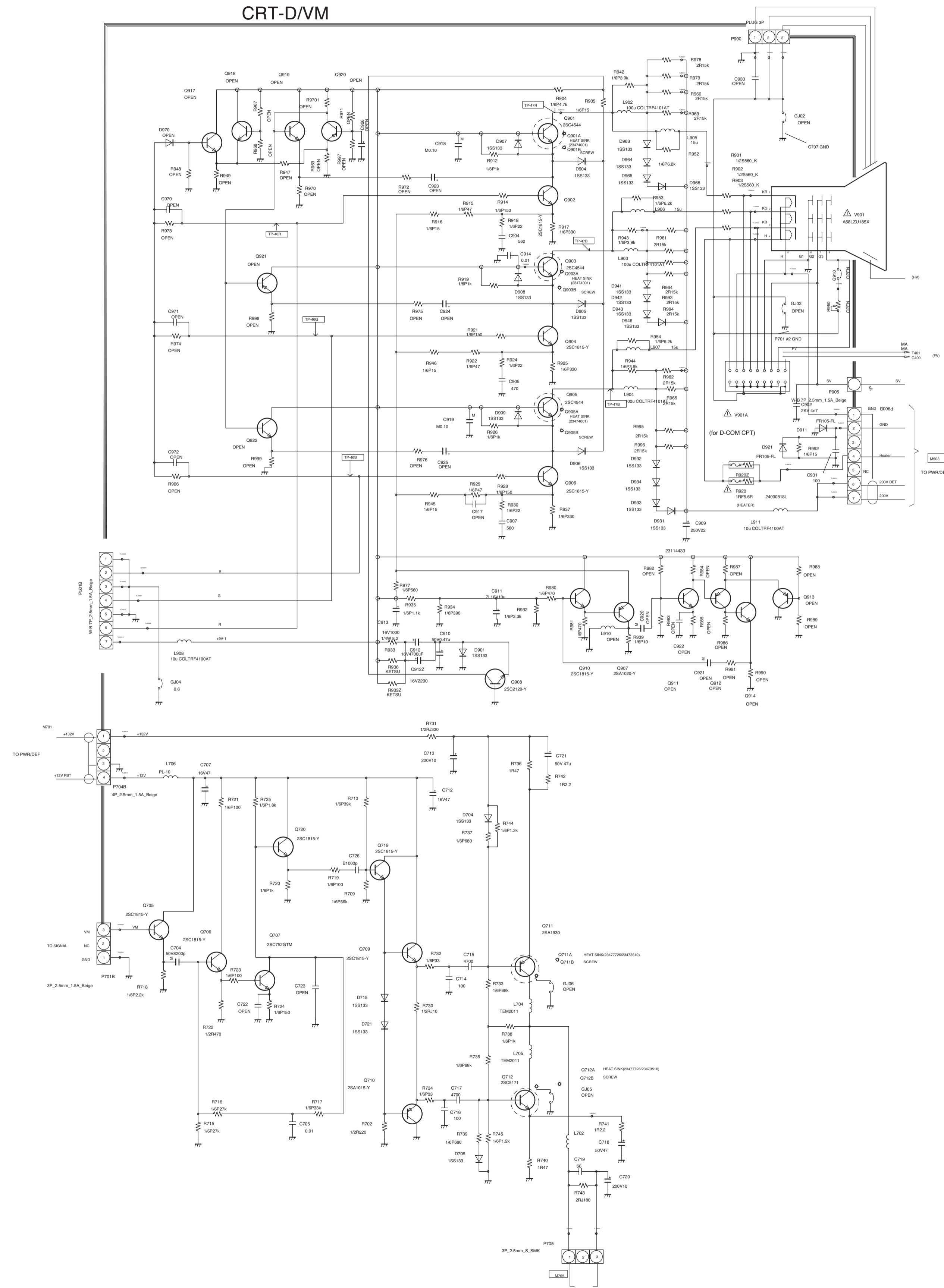

1 2 3 4 5 6 7 8 9 10 11 12

SCHEMATIC DIAGRAM

MODEL : 29CZ8URB/29CZ8URS

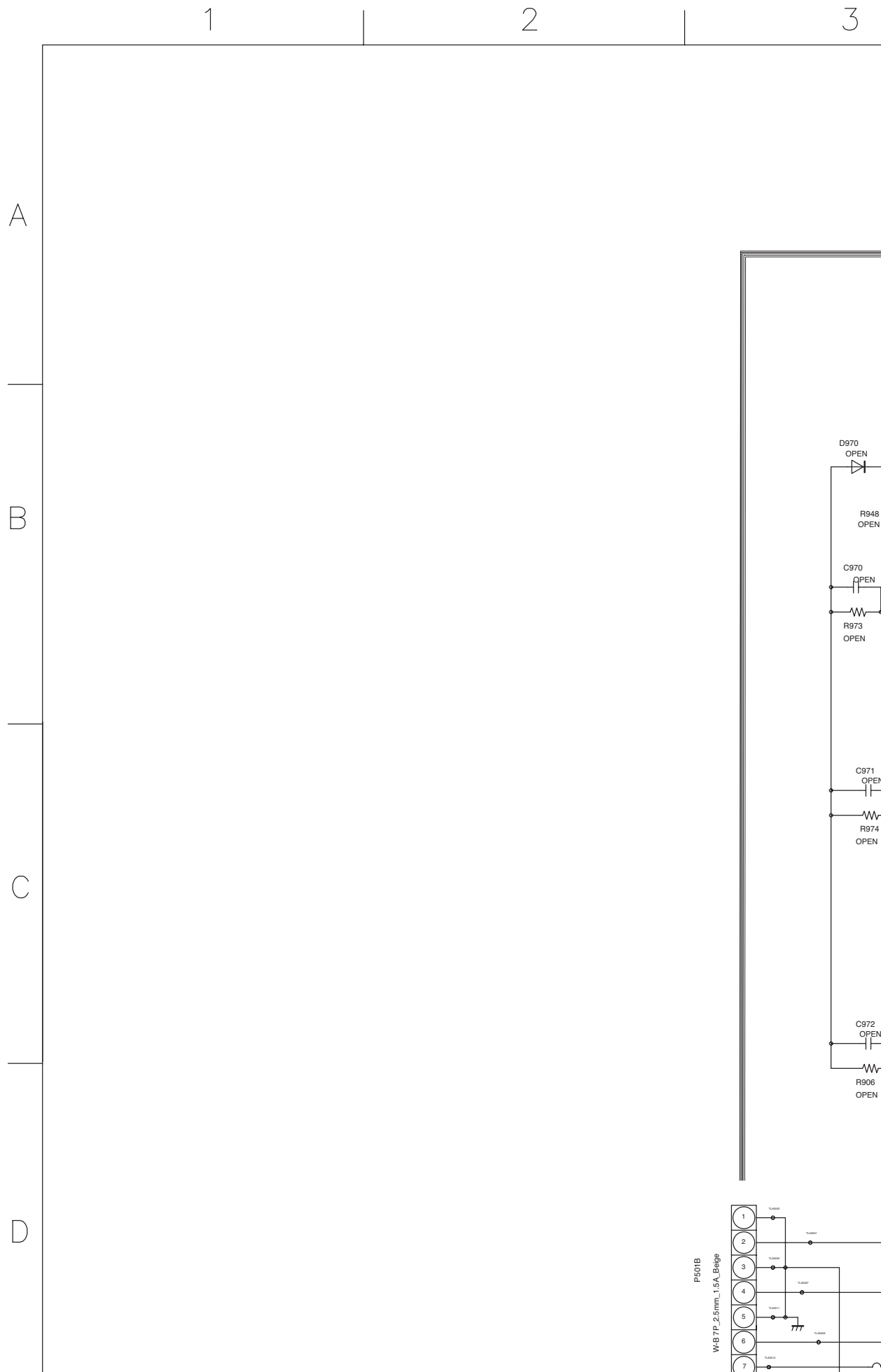

CRT-D/M

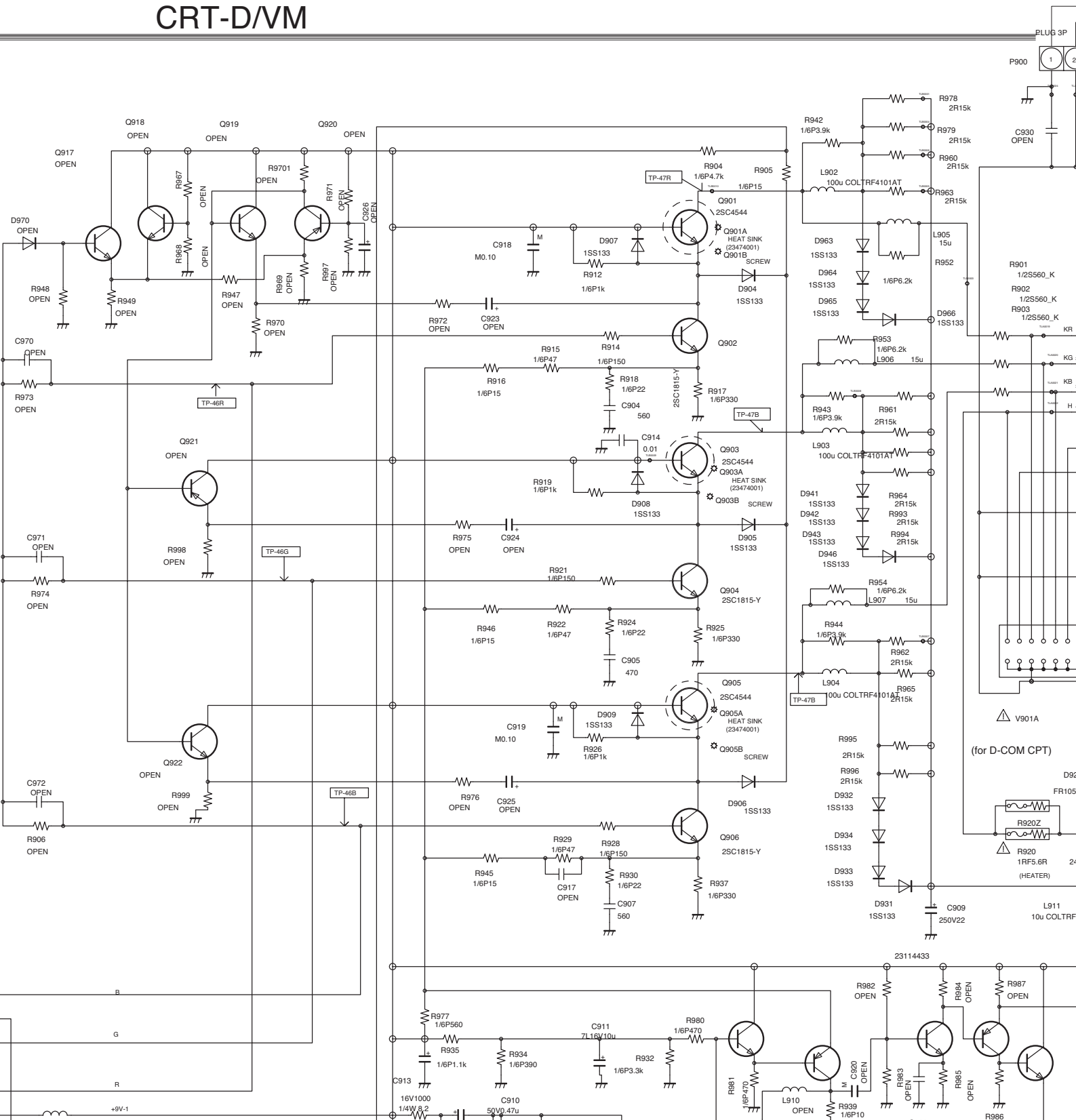

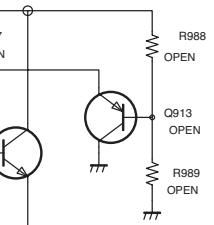
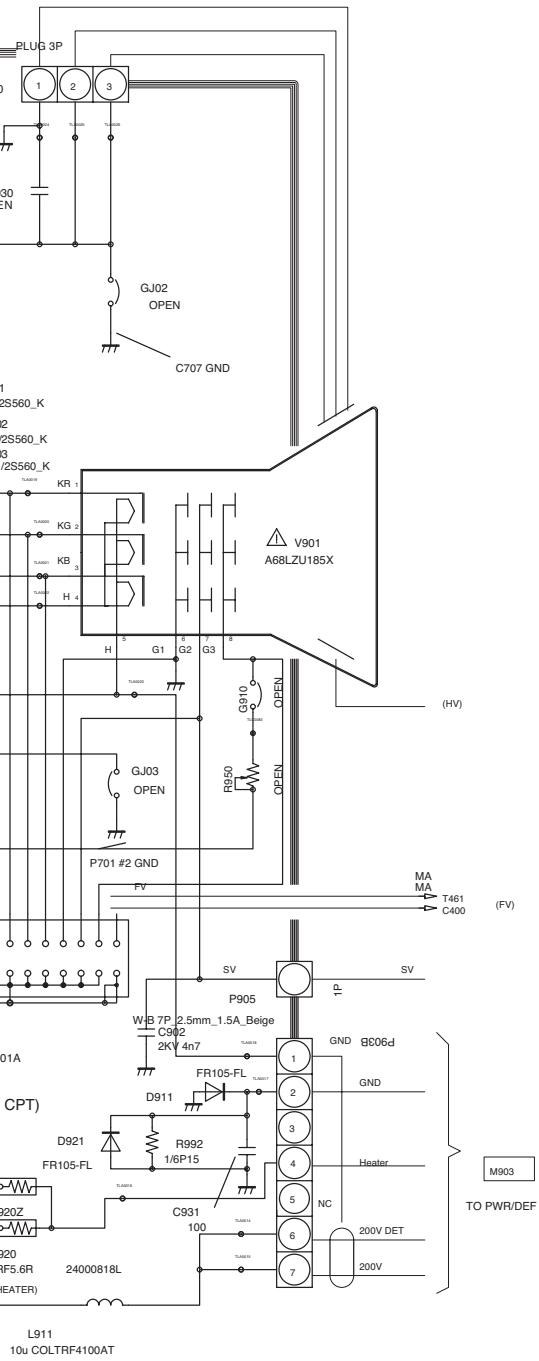

10

11

12

A

B

C

D

E

F

G

H

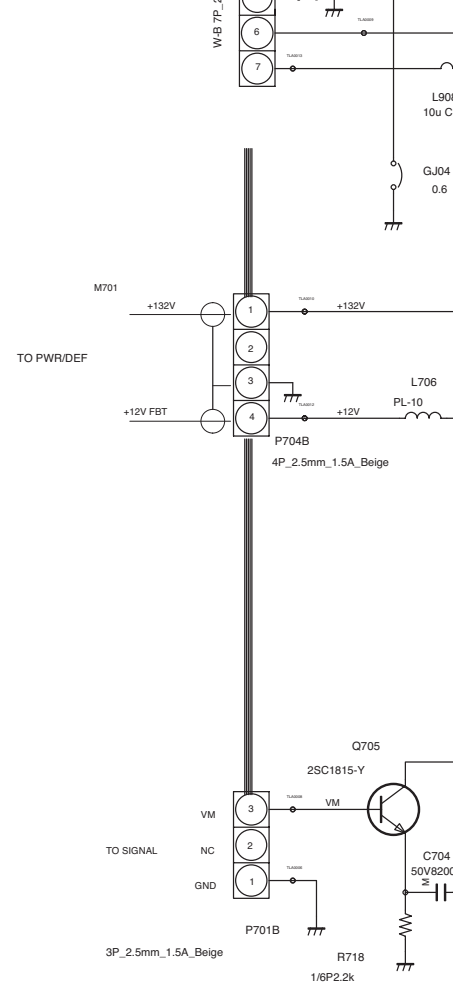

1

2

3

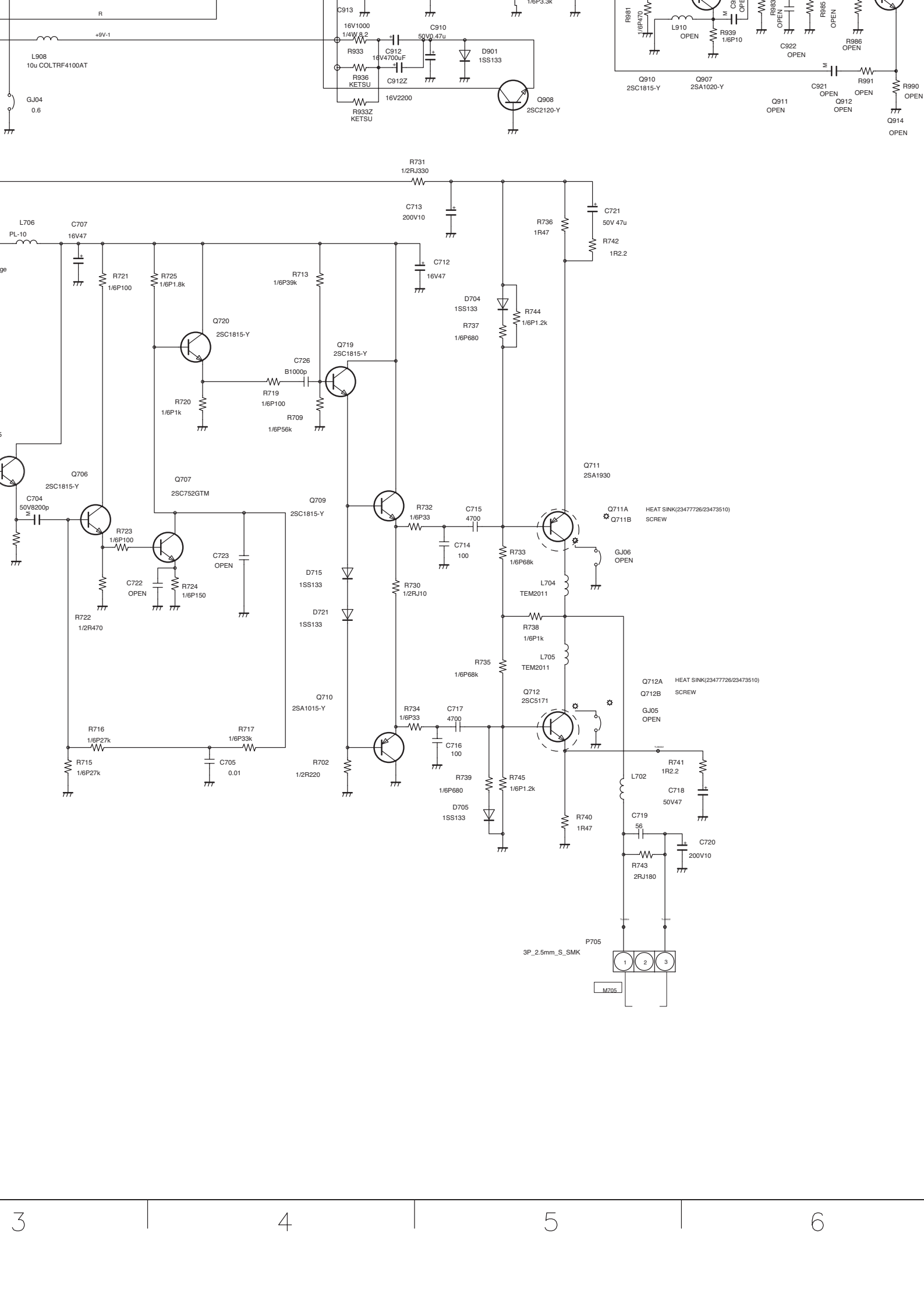

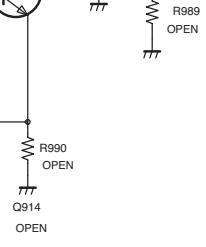

7

8

9

CRT/D
(4 / 6)

E

F

G

H

10

11

12

SCHEMATIC DIAGRAM MODEL : 29CZ8URB/29CZ8URS

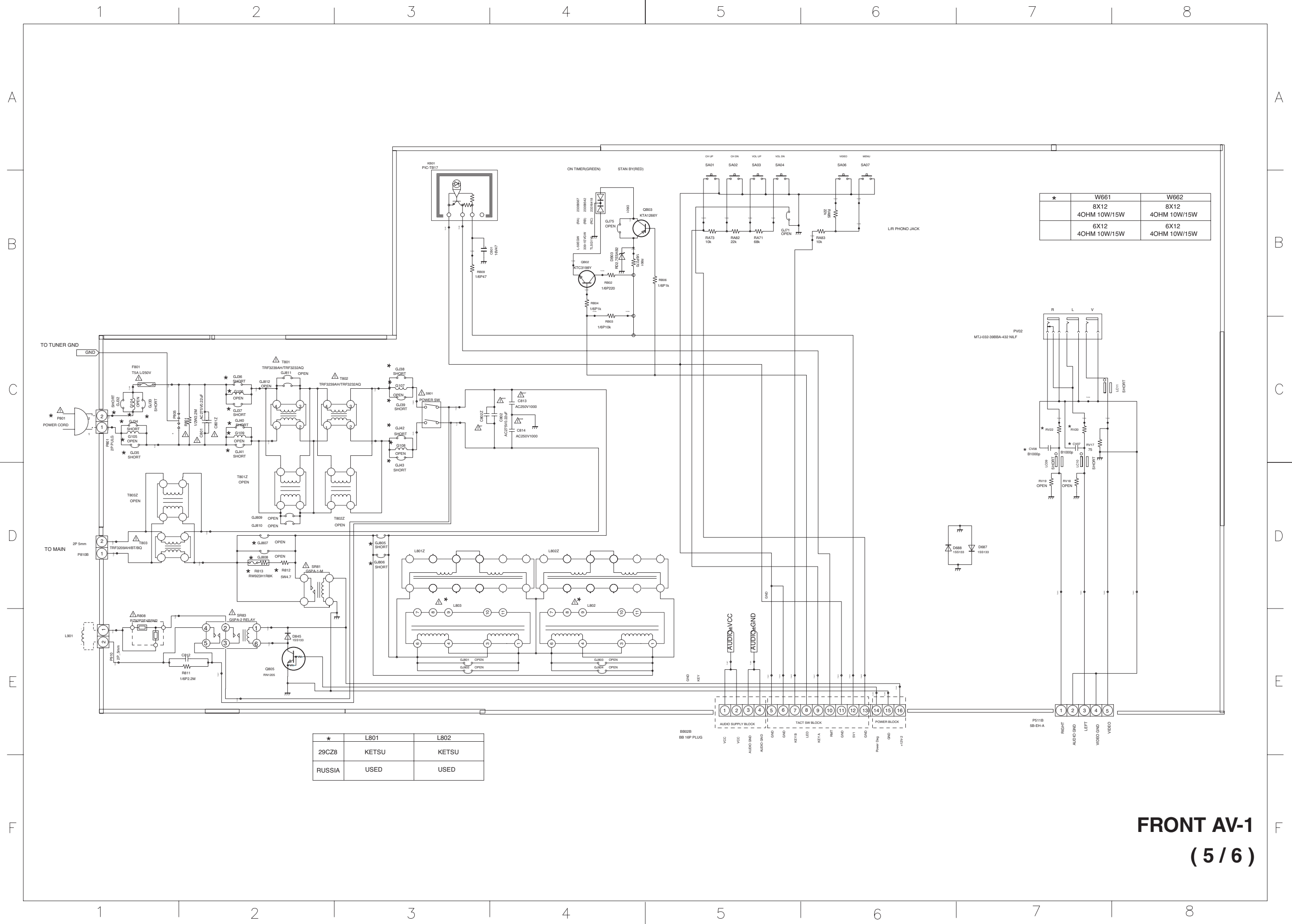

*	L801	L802
29CZ8	KETSU	KETSU
RUSSIA	USED	USED

*	W661	W662
	8X12 40HM 10W/15W	8X12 40HM 10W/15W
	6X12 40HM 10W/15W	6X12 40HM 10W/15W

1	2	3	4	5	6	7	8	9	10	11	12	13	14	15	16
VCC	VCC	AUDIO GND	AUDIO GND	AUDIO GND	GND	GND	GND	KEY	LED	KEY A	REF	GND	KEY B	GND	Power On

FRONT AV-1
(5/6)

SCHEMATIC DIAGRAM MODEL : 29CZ8URB/29CZ8URS

1

2

*	W661	W662
	8X12 4OHM 10W/15W	8X12 4OHM 10W/15W
	6X12 4OHM 10W/15W	6X12 4OHM 10W/15W

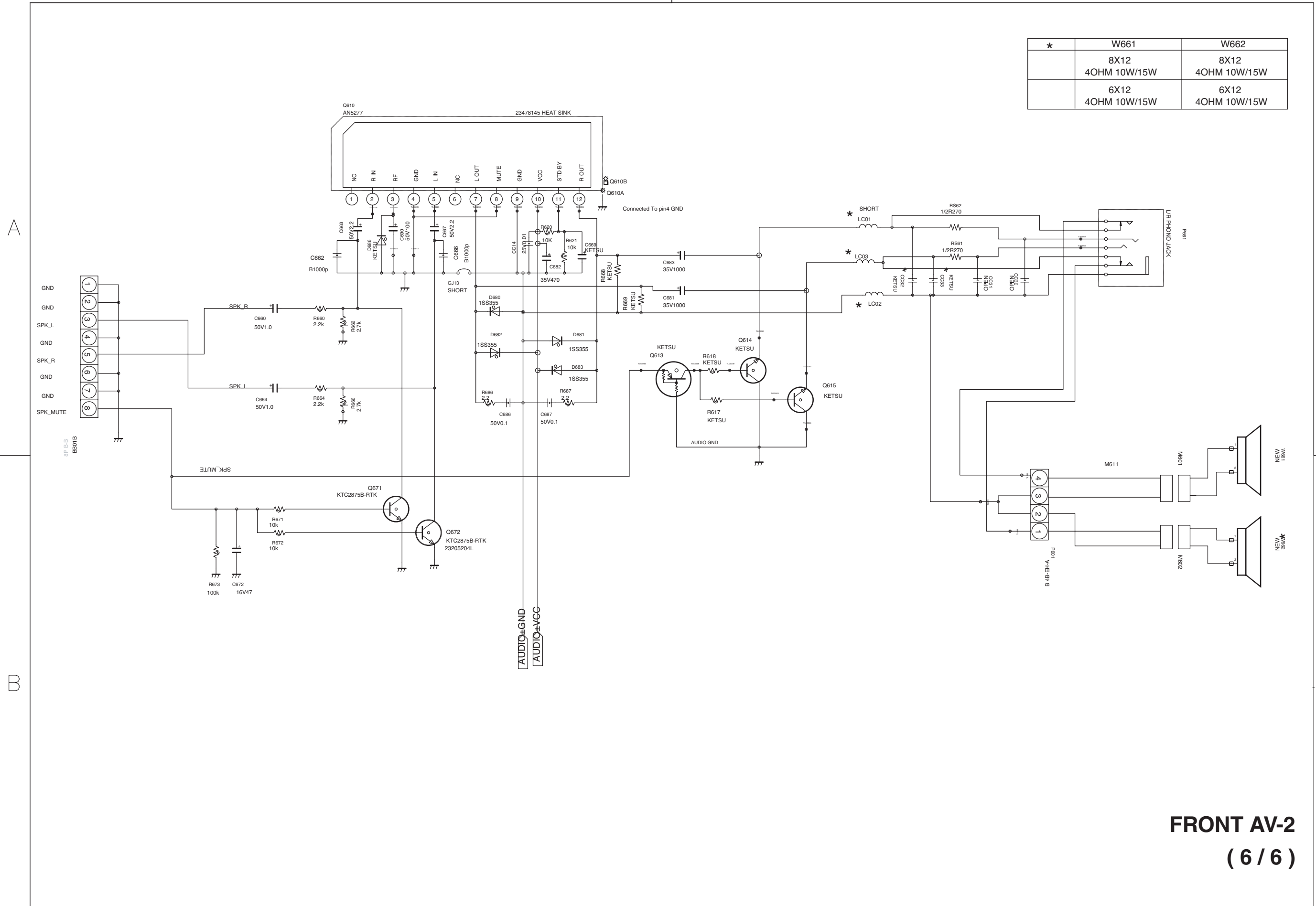

**FRONT AV-2
(6 / 6)**

1

2