

2MBI100N-060

IGBT Module

600V / 100A 2 in one-package

■ Features

- High speed switching
- Voltage drive
- Low inductance module structure

■ Applications

- Inverter for Motor drive
- AC and DC Servo drive amplifier
- Uninterruptible power supply
- Industrial machines, such as Welding machines



■ Maximum ratings and characteristics

● Absolute maximum ratings (at Tc=25°C unless otherwise specified)

Item	Symbol	Rating	Unit
Collector-Emitter voltage	V _{CEs}	600	V
Gate-Emitter voltage	V _{GEs}	±20	V
Collector current	Continuous	I _c	100 A
	1ms	I _c pulse	200 A
	Continuous	-I _c	100 A
	1ms	-I _c pulse	200 A
Max. power dissipation	P _c	400	W
Operating temperature	T _j	+150	°C
Storage temperature	T _{stg}	-40 to +125	°C
Isolation voltage	V _{is}	AC 2500 (1min.)	V
Screw torque	Mounting *1	3.5	N·m
	Terminals *1	3.5	N·m

*1 : Recommendable value : 2.5 to 3.5 N·m(M5)

■ Equivalent Circuit Schematic

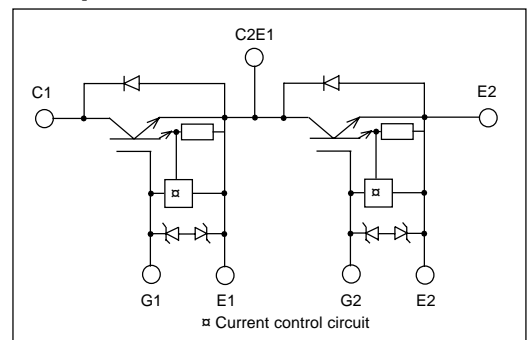

● Electrical characteristics (at Tj=25°C unless otherwise specified)

Item	Symbol	Characteristics			Conditions	Unit
		Min.	Typ.	Max.		
Zero gate voltage collector current	I _{CEs}	–	–	1.0	V _{GE} =0V, V _{CE} =600V	mA
Gate-Emitter leakage current	I _{GES}	–	–	15	V _{CE} =0V, V _{GE} =±20V	µA
Gate-Emitter threshold voltage	V _{GE(th)}	4.5	–	7.5	V _{CE} =20V, I _c =100mA	V
Collector-Emitter saturation voltage	V _{CE(sat)}	–	–	2.8	V _{GE} =15V, I _c =100A	V
Input capacitance	C _{ies}	–	6600	–	V _{GE} =0V	pF
Output capacitance	C _{oes}	–	1470	–	V _{CE} =10V	
Reverse transfer capacitance	C _{res}	–	670	–	f=1MHz	
Turn-on time	t _{on}	–	0.6	1.2	V _{CC} =300V	µs
	t _r	–	0.2	0.6	I _c =100A	
Turn-off time	t _{off}	–	0.6	1.0	V _{GE} =±15V	µs
	t _f	–	0.2	0.35	R _G =24 ohm	
Diode forward on voltage	V _F	–	–	3.0	I _F =100A, V _{GE} =0V	V
Reverse recovery time	t _{rr}	–	–	0.3	I _F =100A	µs

● Thermal resistance characteristics

Item	Symbol	Characteristics			Conditions	Unit
		Min.	Typ.	Max.		
Thermal resistance	R _{th(j-c)}	–	–	0.31	IGBT	°C/W
	R _{th(j-c)}	–	–	0.7	Diode	°C/W
	R _{th(c-f)*2}	–	0.05	–	the base to cooling fin	°C/W

*2 : This is the value which is defined mounting on the additional cooling fin with thermal compound

■ Characteristics (Representative)

Collector current vs. Collector-Emitter voltage
T_J=25°C

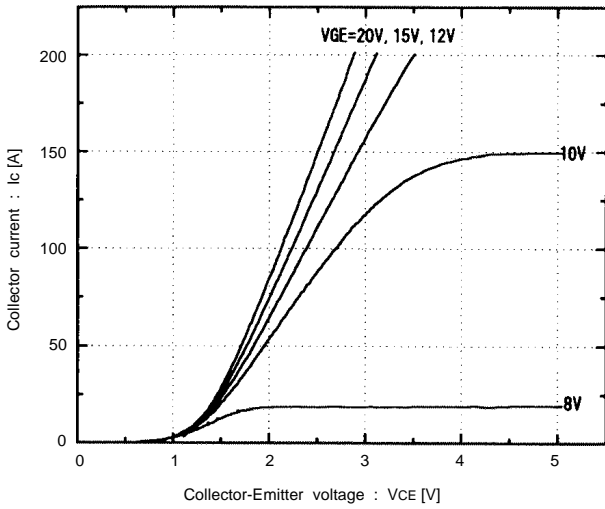

Collector current vs. Collector-Emitter voltage
T_J=125°C

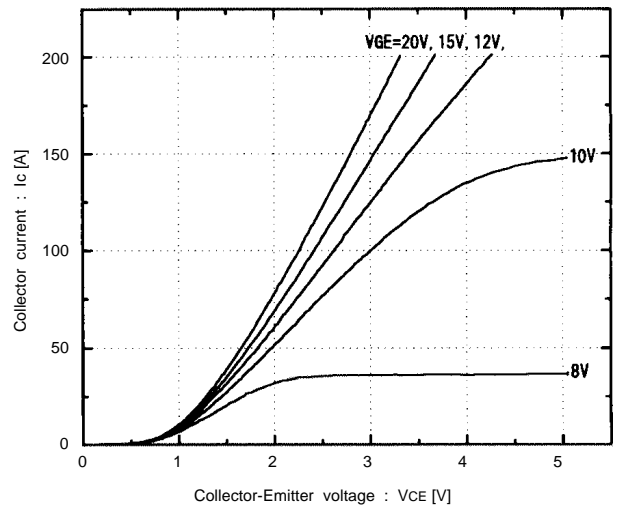

Collector-Emitter vs. Gate-Emitter voltage
T_J=25°C

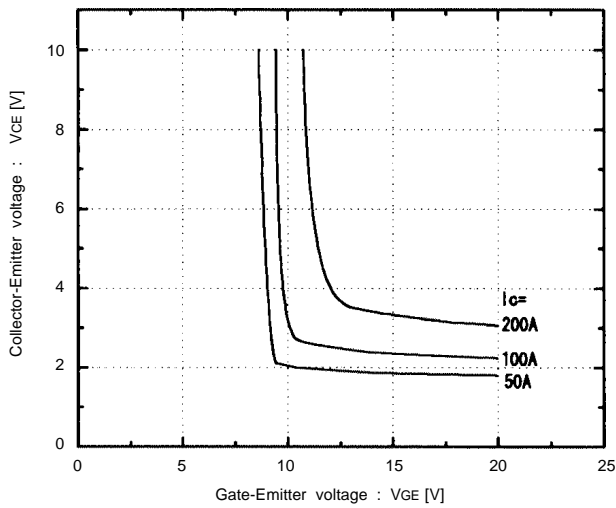

Collector-Emitter vs. Gate-Emitter voltage
T_J=125°C

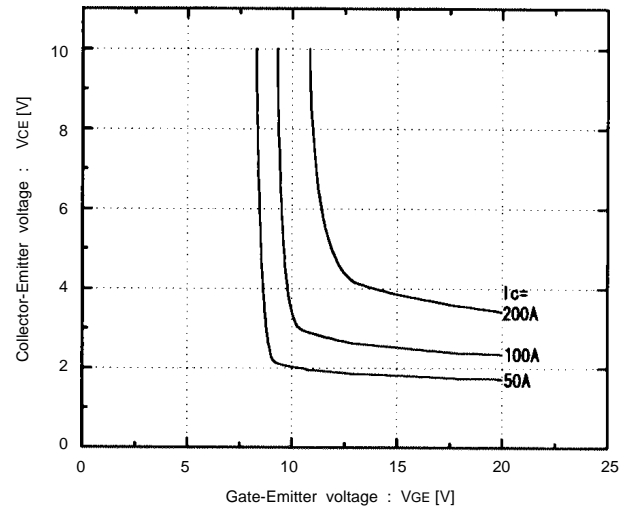

Switching time vs. Collector current
V_{CC}=300V, R_G=24 ohm, V_{GE}=±15V, T_J=25°C

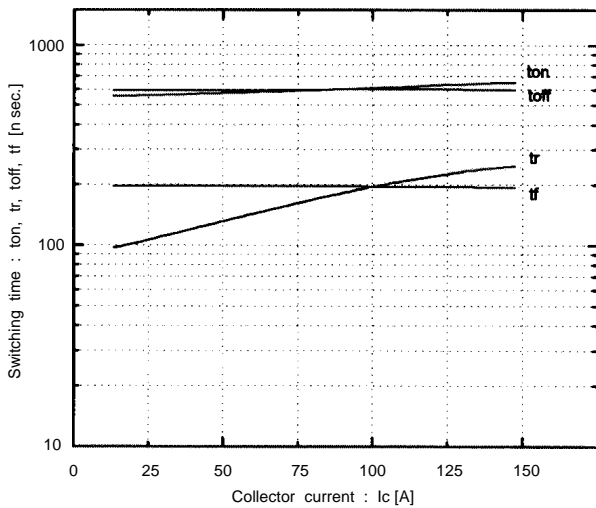

Switching time vs. Collector current
V_{CC}=300V, R_G=24 ohm, V_{GE}=±15V, T_J=125°C

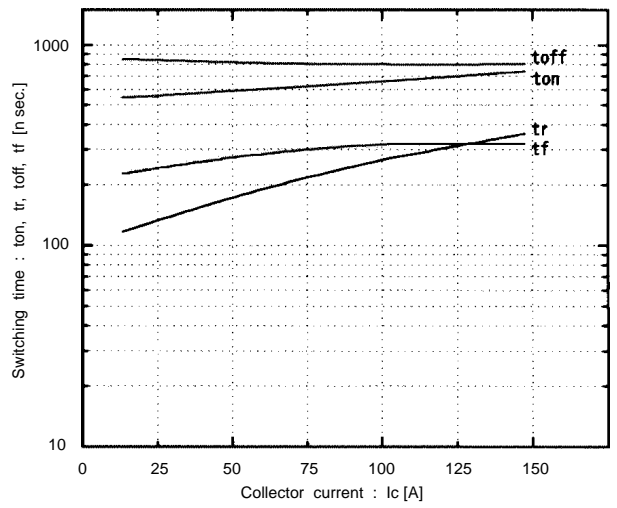

Switching time vs. RG
Vcc=300V, Ic=100A, VGE=±15V, Tj=25°C

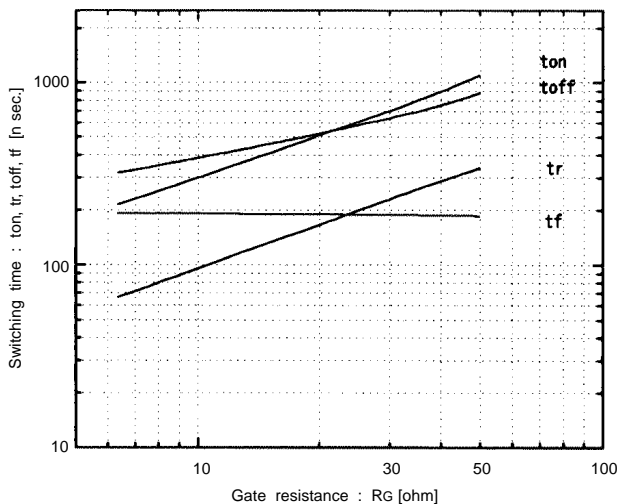

Dynamic input characteristics
Tj=25°C

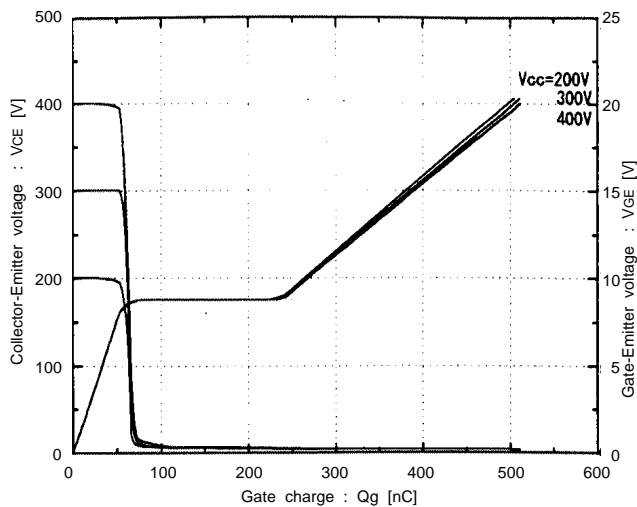

Forward current vs. Forward voltage
VGE=0V

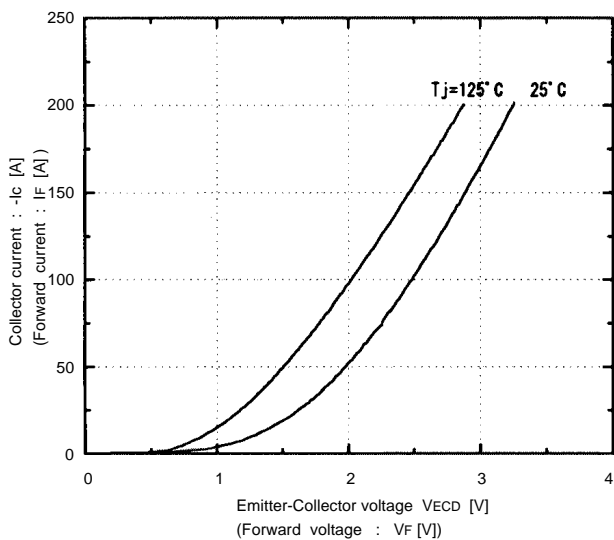

Reverse recovery characteristics
trr, Irr, vs. IF

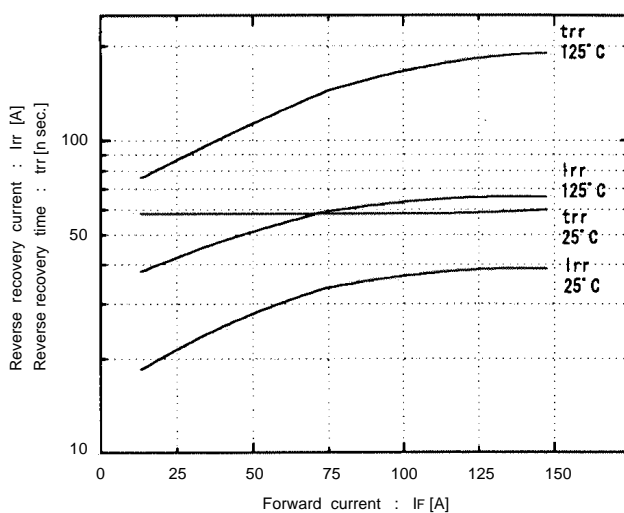

Switching loss vs. Collector current
Vcc=300V, RG=24 ohm, VGE=±15V

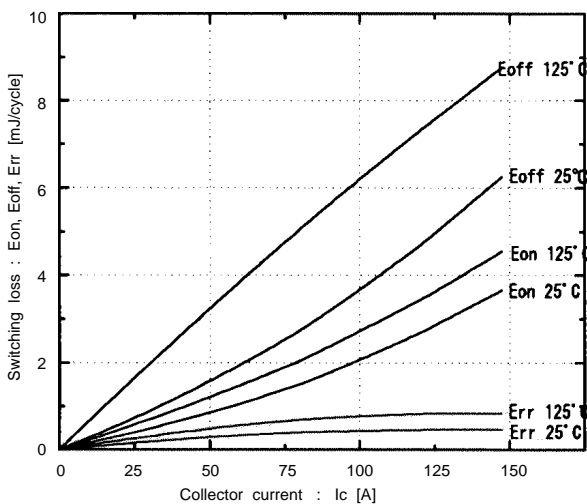

Reversed biased safe operating area
+VGE=15V, -VGE ≤ 15V, Tj ≤ 125°C, RG ≥ 24 ohm

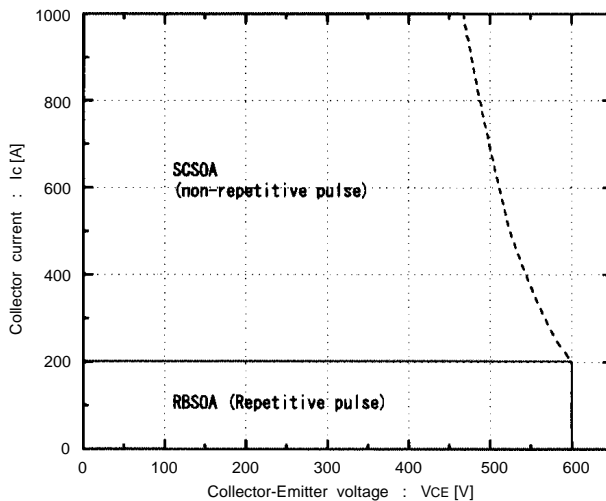

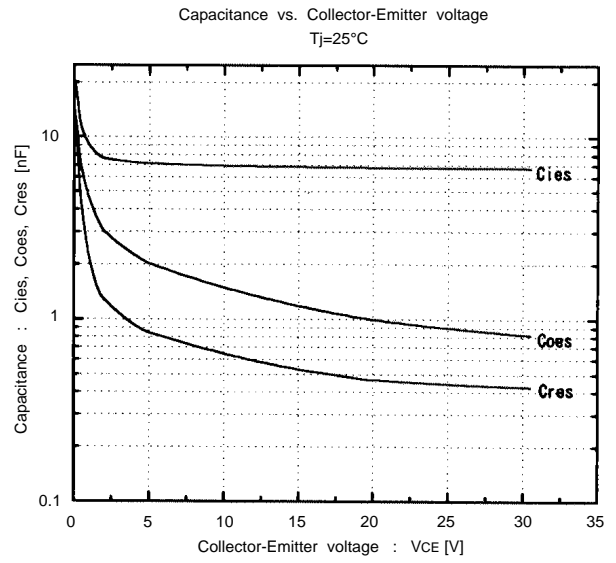
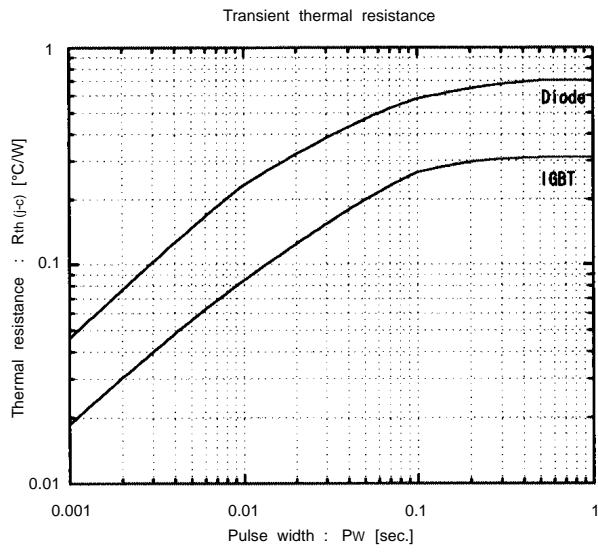

■ Outline Drawings, mm

