

IGBT MODULE (N series)

■ Features

- Square RBSOA
- Low Saturation Voltage
- Less Total Power Dissipation
- Improved FWD Characteristic
- Minimized Internal Stray Inductance
- Overcurrent Limiting Function (4-5 Times Rated Current)

■ Applications

- High Power Switching
- A.C. Motor Controls
- D.C. Motor Controls
- Uninterruptible Power Supply

■ Outline Drawing

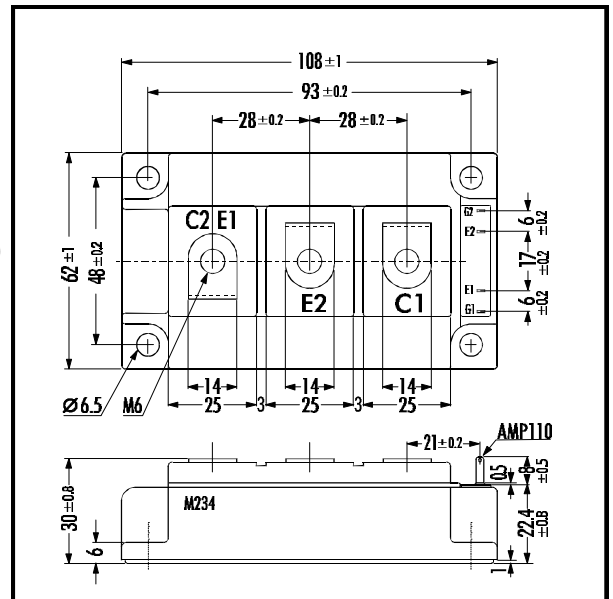

■ Maximum Ratings and Characteristics

• Absolute Maximum Ratings (T_c=25°C)

Items	Symbols	Ratings	Units
Collector-Emitter Voltage	V _{CE(S)}	1200	V
Gate -Emitter Voltage	V _{GES}	± 20	V
Collector Current	Continuous	I _C	100
	1ms	I _{C PULSE}	200
	Continuous	-I _C	100
	1ms	-I _{C PULSE}	200
Max. Power Dissipation	P _C	780	W
Operating Temperature	T _j	+150	°C
Storage Temperature	T _{stg}	-40 ~ +125	°C
Isolation Voltage	A.C. 1min. V _{is}	2500	V
Screw Torque	Mounting *1	3.5	Nm
	Terminals *2	4.5	

Note: *1:Recommendable Value; 2.5 - 3.5 Nm (M5) or (M6)
*2:Recommendable Value; 3.5 - 4.5 Nm (M6)

• Electrical Characteristics (at T_j=25°C)

Items	Symbols	Test Conditions	Min.	Typ.	Max.	Units
Zero Gate Voltage Collector Current	I _{CE(S)}	V _{GE} =0V V _{CE} =1200V			2.0	mA
Gate-Emitter Leakage Current	I _{GES}	V _{CE} =0V V _{GE} =± 20V			30	μA
Gate-Emitter Threshold Voltage	V _{GE(th)}	V _{GE} =20V I _C =100mA	4.5		7.5	V
Collector-Emitter Saturation Voltage	V _{CE(sat)}	V _{GE} =15V I _C =100A			3.3	V
Input capacitance	C _{ies}	V _{GE} =0V		16000		pF
Output capacitance	C _{oes}	V _{CE} =10V		5800		
Reverse Transfer capacitance	C _{res}	f=1MHz		5160		
Turn-on Time	t _{ON}	V _{CC} =600V		0.65	1.2	μs
	t _r	I _C =100A		0.25	0.6	
Turn-off Time	t _{OFF}	V _{GE} =± 15V		0.85	1.5	
	t _f	R _G =9.1Ω		0.35	0.5	
Diode Forward On-Voltage	V _F	I _F =100A V _{GE} =0V			3.0	V
Reverse Recovery Time	t _{rr}	I _F =100A			350	ns

• Thermal Characteristics

Items	Symbols	Test Conditions	Min.	Typ.	Max.	Units
Thermal Resistance	R _{th(j-c)}	IGBT			0.16	°C/W
	R _{th(j-e)}	Diode			0.43	
	R _{th(c-f)}	With Thermal Compound		0.025		

■ Equivalent Circuit

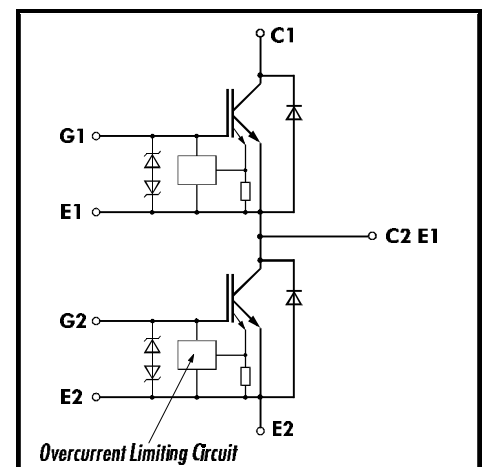

Collector current vs. Collector-Emitter voltage

$T_j=25^\circ\text{C}$

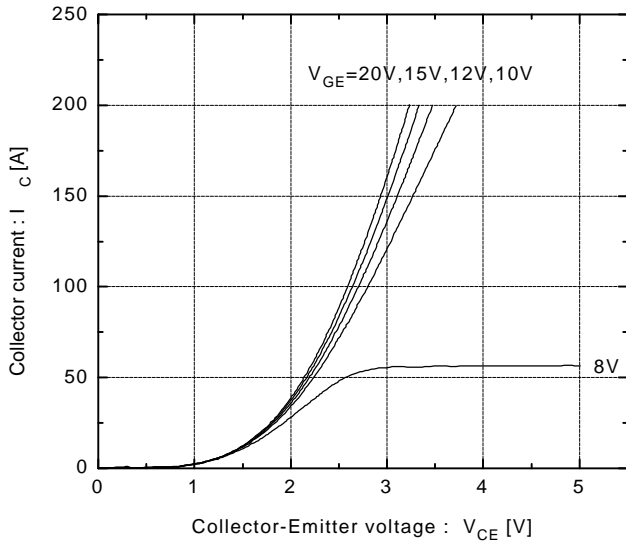

Collector current vs. Collector-Emitter voltage

$T_j=125^\circ\text{C}$

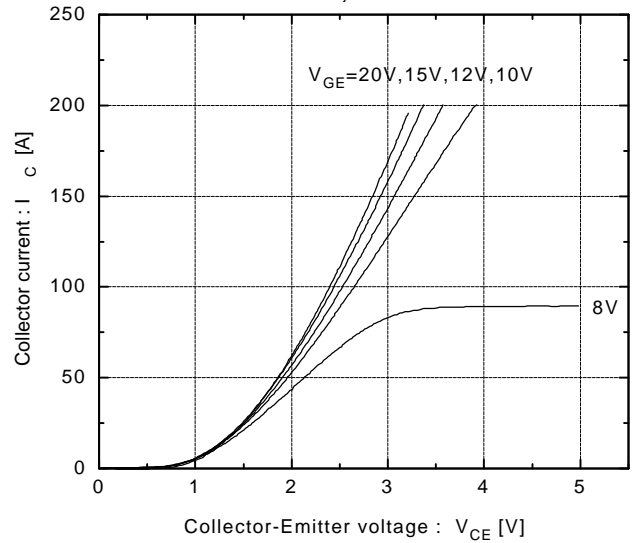

Collector-Emitter vs. Gate-Emitter voltage

$T_j=25^\circ\text{C}$

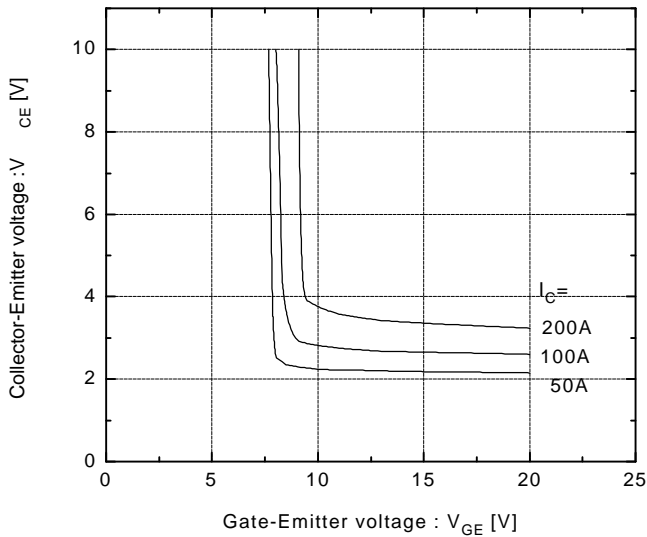

Collector-Emitter vs. Gate-Emitter voltage

$T_j=125^\circ\text{C}$

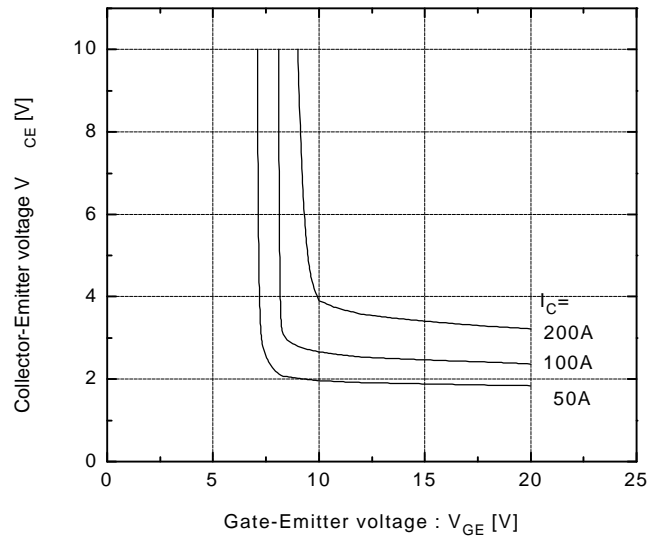

Switching time vs. Collector current

$V_{CC}=600\text{V}, R_G=9.1\Omega, V_{GE}=\pm 15\text{V}, T_j=25^\circ\text{C}$

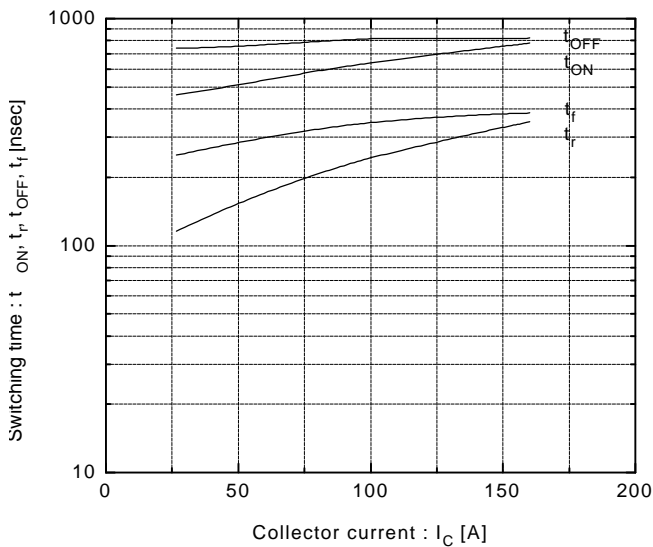

Switching time vs. Collector current

$V_{CC}=600\text{V}, R_G=9.1\Omega, V_{GE}=\pm 15\text{V}, T_j=125^\circ\text{C}$

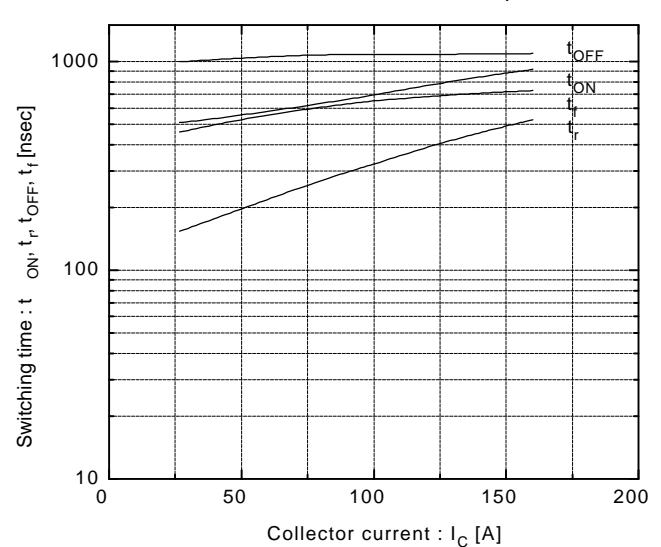

Switching Time vs. R_G

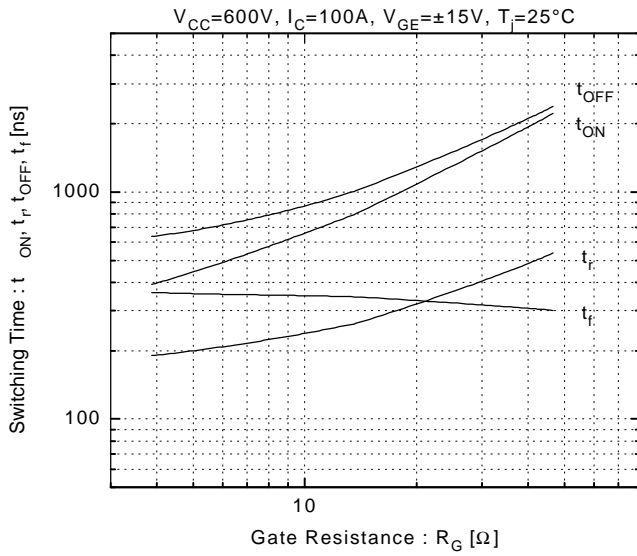

Dynamic Input Characteristics

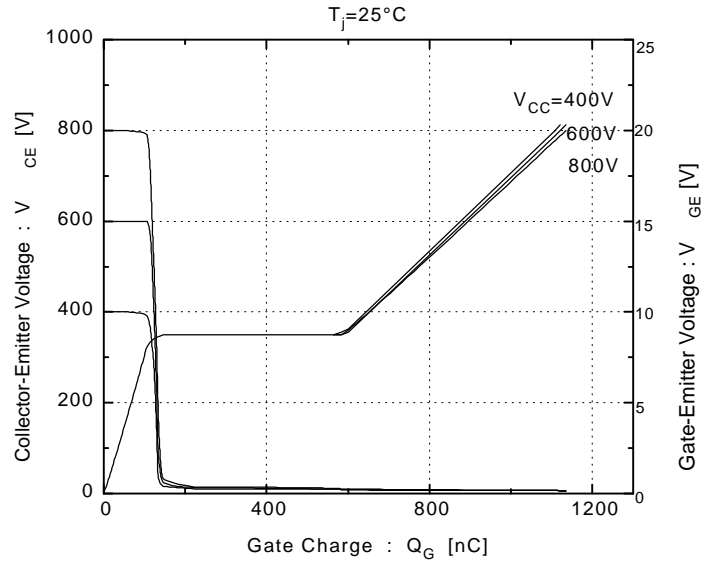

Forward Current vs. Forward Voltage

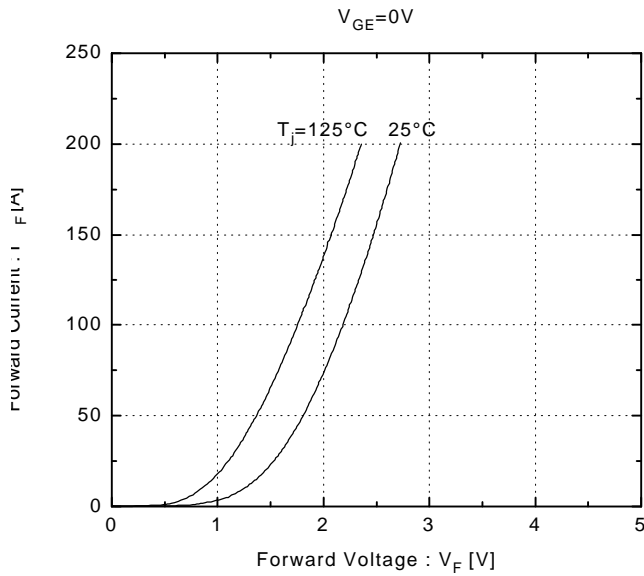

Reverse Recovery Characteristics

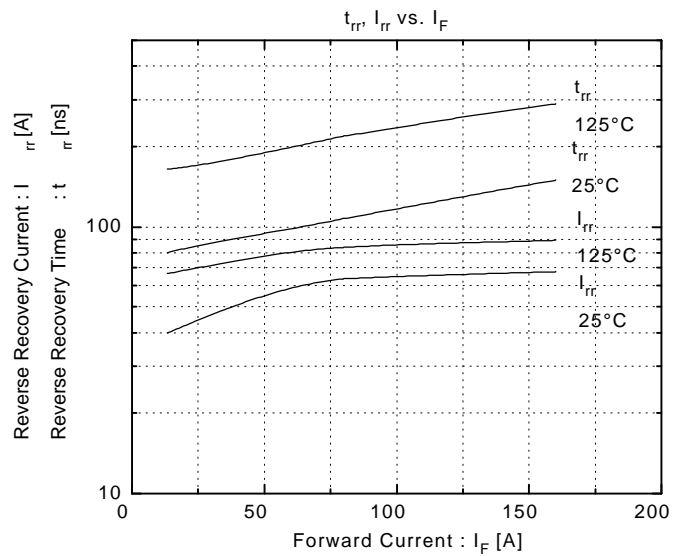

Transient Thermal Resistance

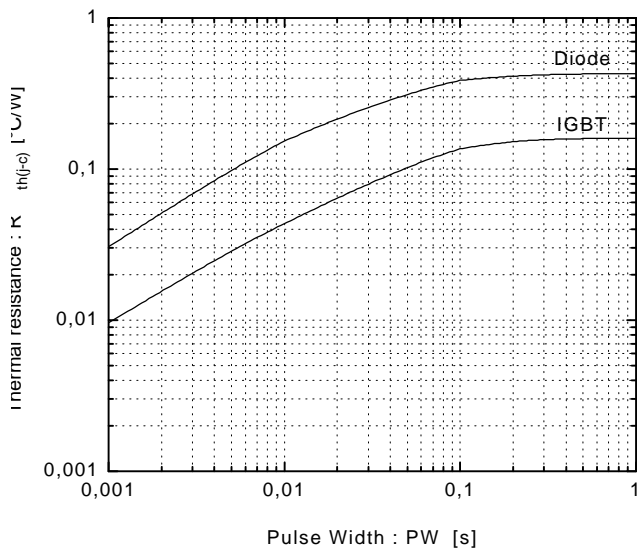

Reversed Biased Safe Operating Area

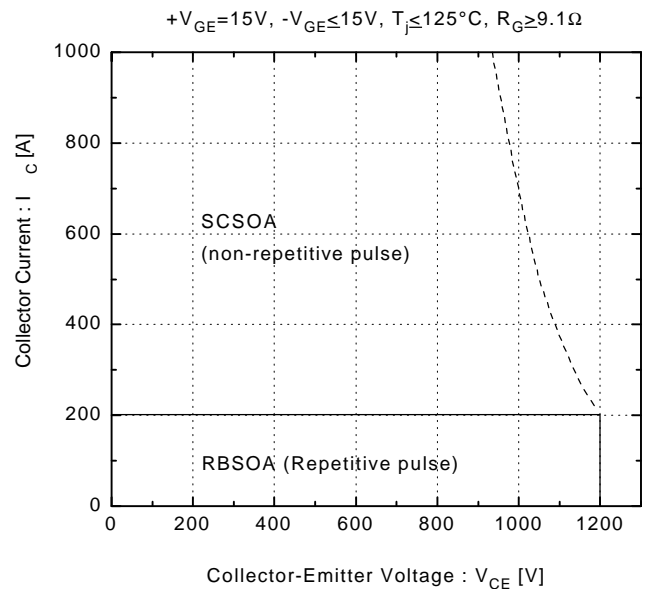

Switching loss vs. Collector current

$V_{CC}=600V, R_G=9.1\Omega, V_{GE}=\pm 15V$

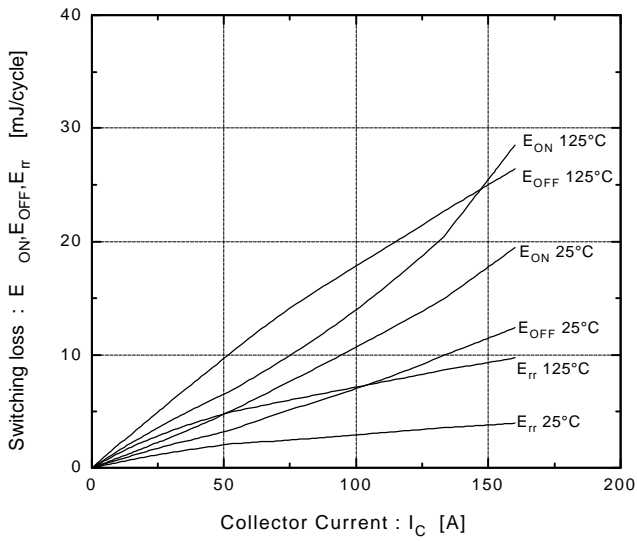

Capacitance vs. Collector-Emitter voltage

$T_J=25^\circ C$

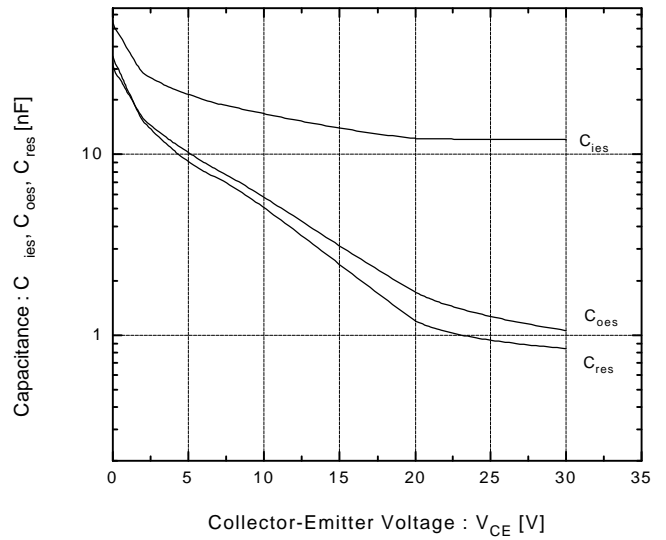

Fuji Electric GmbH

Lyoner Straße 26

D-60528 Frankfurt/M

Tel.: 069 - 66 90 29 - 0

Fax.: 069 - 66 90 29 - 56

Fuji Electric (UK) Ltd.

Commonwealth House
2 Chalkhill Road Hammersmith

London W6 8DW, UK

Tel.: 0181 - 233 11 30

Fax.: 0181 - 233 11 60