

### 600V / 400A 2 in one-package

#### ■ Features

- VCE(sat) classified for easy parallel connection
- High speed switching
- Voltage drive
- Low inductance module structure

#### ■ Applications

- Inverter for Motor drive
- AC and DC Servo drive amplifier
- Uninterruptible power supply
- Industrial machines, such as Welding machines

#### ■ Maximum ratings and characteristics

##### ● Absolute maximum ratings (at Tc=25°C unless otherwise specified)

Item	Symbol	Rating	Unit
Collector-Emitter voltage	V <sub>CES</sub>	600	V
Gate-Emitter voltage	V <sub>GES</sub>	±20	V
Collector current	Continuous	I <sub>c</sub>	400
	1ms	I <sub>c</sub> pulse	800
		-I <sub>c</sub>	400
	1ms	-I <sub>c</sub> pulse	800
Max. power dissipation	P <sub>c</sub>	1500	W
Operating temperature	T <sub>j</sub>	+150	°C
Storage temperature	T <sub>stg</sub>	-40 to +125	°C
Isolation voltage	V <sub>is</sub>	AC 2500 (1min.)	V
Screw torque	Mounting *1	3.5	N·m
	Terminals *2	4.5	N·m

\*1 Recommendable value : 2.5 to 3.5 N·m (M5) or (M6)

\*2 Recommendable value : 3.5 to 4.5 N·m

##### ● Electrical characteristics (at Tj=25°C unless otherwise specified)

Item	Symbol	Characteristics			Conditions	Unit
		Min.	Typ.	Max.		
Zero gate voltage collector current	I <sub>CES</sub>	-	-	2.0	V <sub>GE</sub> =0V, V <sub>CE</sub> =600V	mA
Gate-Emitter leakage current	I <sub>GES</sub>	-	-	30	V <sub>CE</sub> =0V, V <sub>GE</sub> =±20V	µA
Gate-Emitter threshold voltage	V <sub>GE(th)</sub>	4.5	-	7.5	V <sub>CE</sub> =20V, I <sub>c</sub> =400mA	V
Collector-Emitter saturation voltage	V <sub>CE(sat)</sub>	1.8	-	2.8	V <sub>GE</sub> =15V, I <sub>c</sub> =400A	V
Input capacitance	C <sub>ies</sub>	-	26400	-	V <sub>GE</sub> =0V	pF
Output capacitance	C <sub>oes</sub>	-	5870	-	V <sub>CE</sub> =10V	
Reverse transfer capacitance	C <sub>res</sub>	-	2670	-	f=1MHz	
Turn-on time	t <sub>on</sub>	-	0.6	1.2	V <sub>CC</sub> =300V	µs
	t <sub>r</sub>	-	0.2	0.6	I <sub>c</sub> =400A	
Turn-off time	t <sub>off</sub>	-	0.6	1.0	V <sub>GE</sub> =±15V	
	t <sub>f</sub>	-	0.2	0.35	R <sub>G</sub> =4.7ohm	
Diode forward on voltage	V <sub>F</sub>	-	-	3.0	I <sub>F</sub> =400A, V <sub>GE</sub> =0V	V
Reverse recovery time	t <sub>rr</sub>	-	-	0.3	I <sub>F</sub> =400A	µs

##### ● Thermal resistance characteristics

Item	Symbol	Characteristics			Conditions	Unit
		Min.	Typ.	Max.		
Thermal resistance	R <sub>th(j-c)</sub>	-	-	0.085	IGBT	°C/W
	R <sub>th(j-c)</sub>	-	-	0.15	Diode	°C/W
	R <sub>th(c-f)*</sub>	-	0.025	-	the base to cooling fin	°C/W

\* : This is the value which is defined mounting on the additional cooling fin with thermal compound



#### ■ Equivalent Circuit Schematic

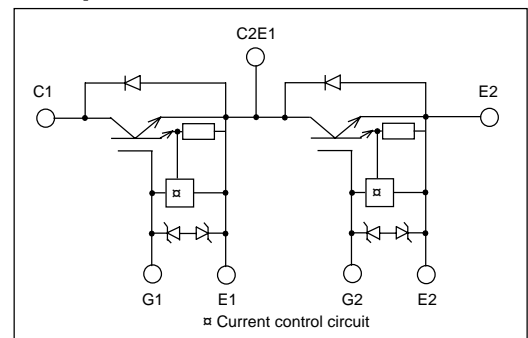

##### ● VCE(sat) classification

Rank	Lenge	Conditions
F	1.85 to 2.10V	I <sub>c</sub> = 400A V <sub>GE</sub> = 15V T <sub>j</sub> = 25°C
A	2.00 to 2.25V	
B	2.15 to 2.40V	
C	2.30 to 2.60V	
D	2.50 to 2.80V	

Characteristics (Representative)

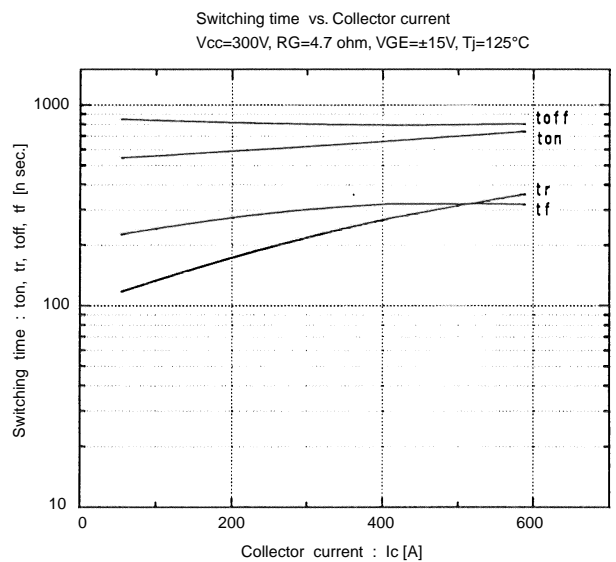
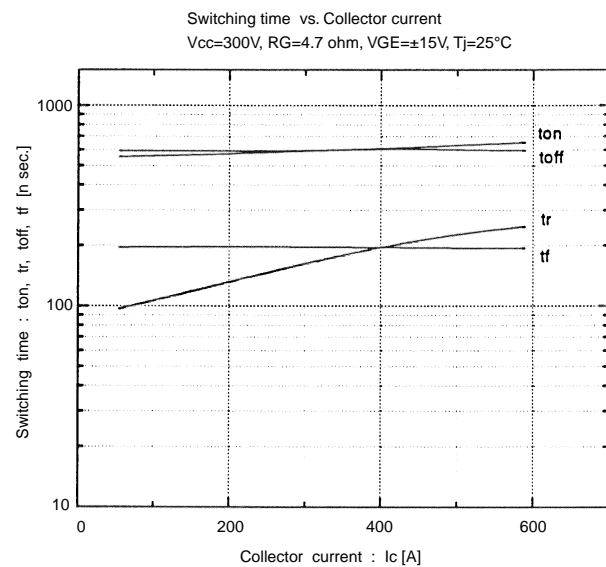
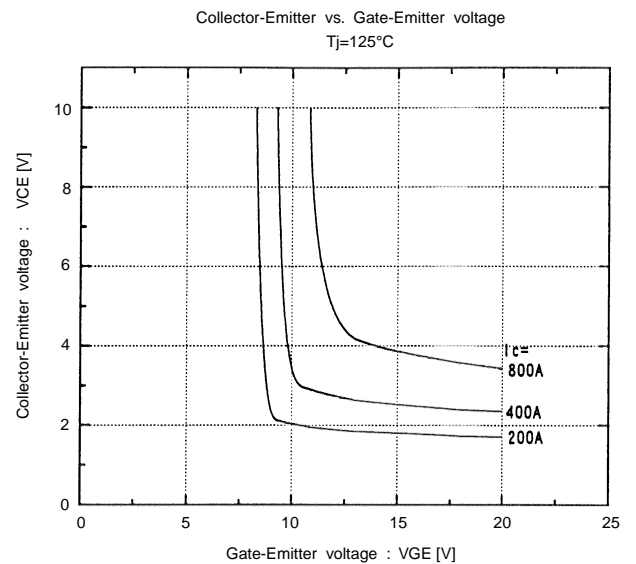
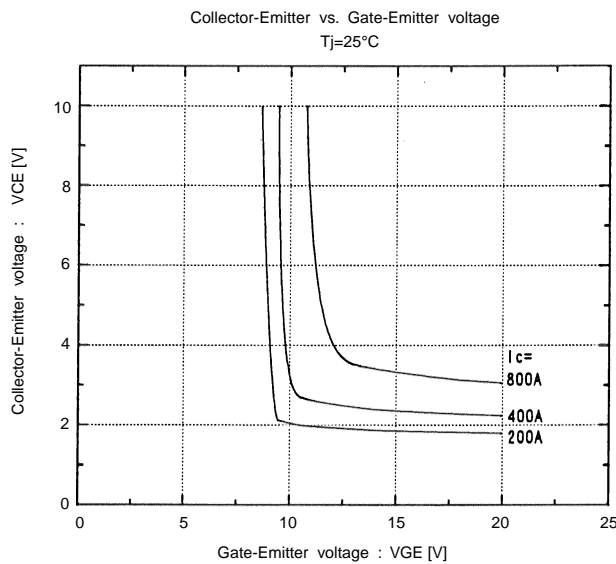
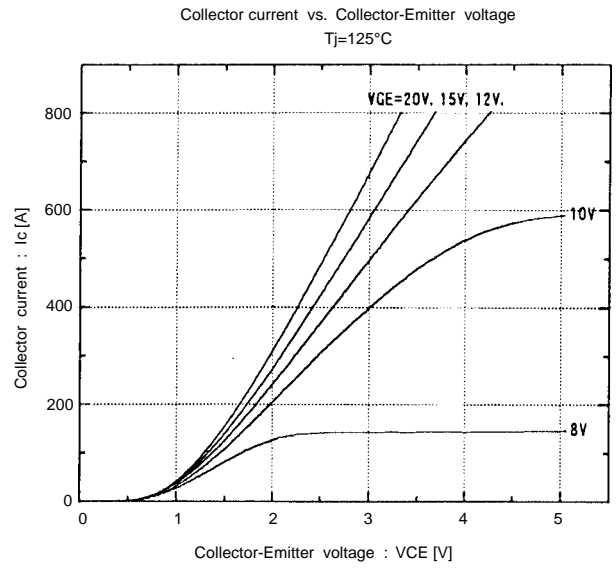
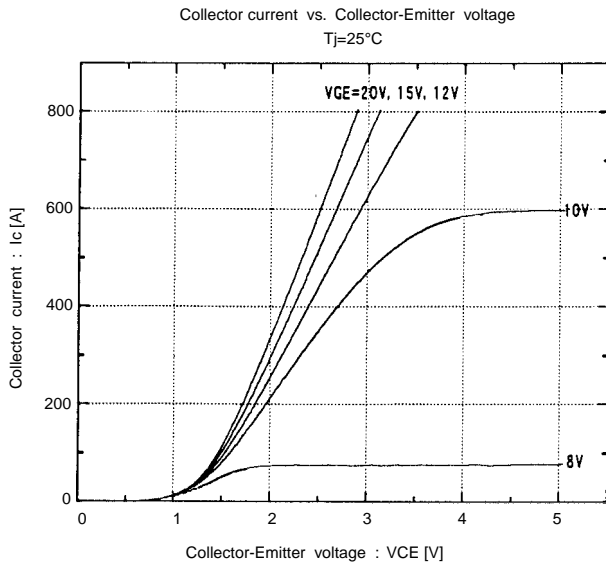

Switching time vs. RG  
 $V_{cc}=300V, I_c=400A, V_{GE}=\pm 15V, T_j=25^\circ C$

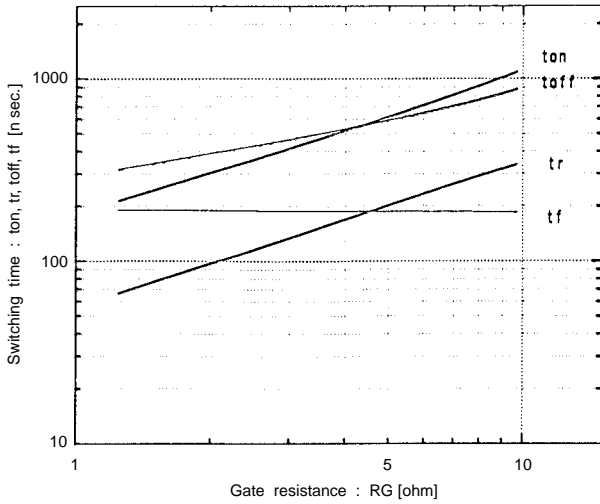

Dynamic input characteristics  
 $T_j=25^\circ C$

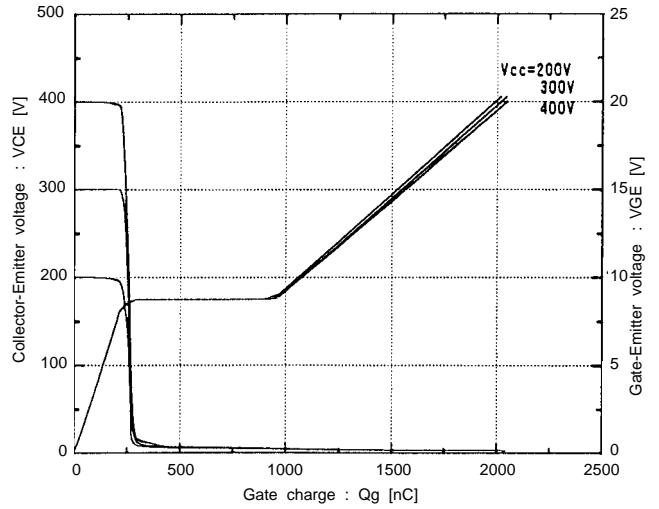

Forward current vs. Forward voltage  
 $V_{GE}=0V$

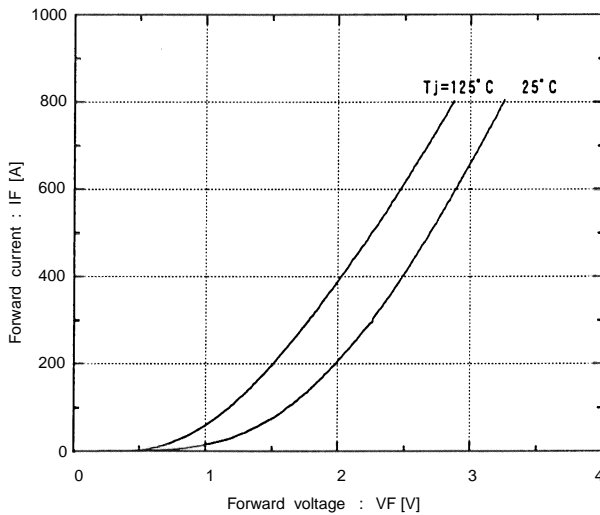

Reverse recovery characteristics  
 $t_{rr}, I_{rr}$ , vs.  $I_F$

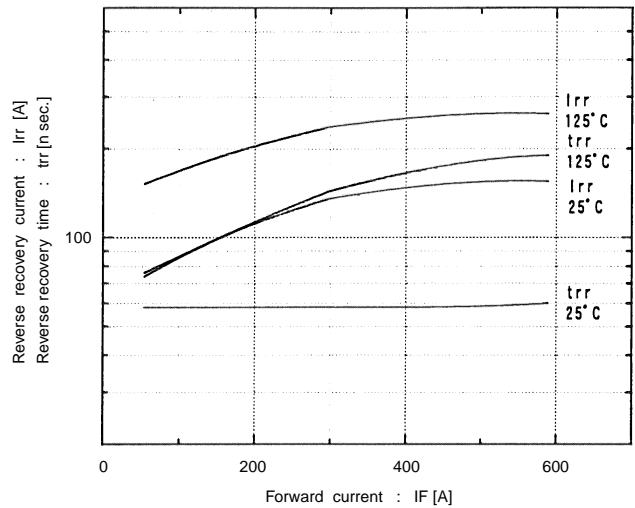

Transient thermal resistance

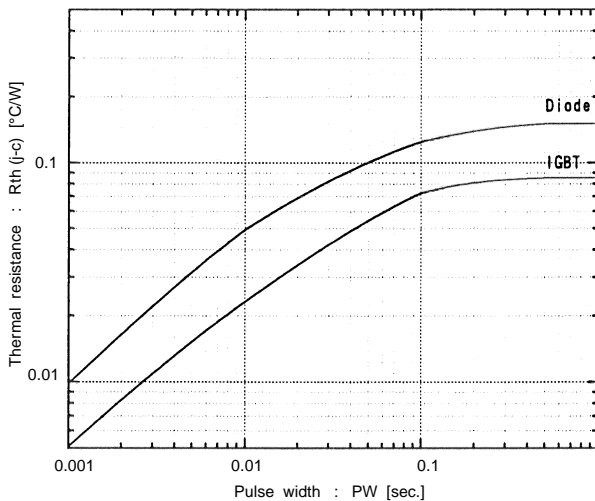

Reversed biased safe operating area  
 $+V_{GE}=15V, -V_{GE} \le 15V, T_j \le 125^\circ C, R_G \ge 4.7 \text{ ohm}$

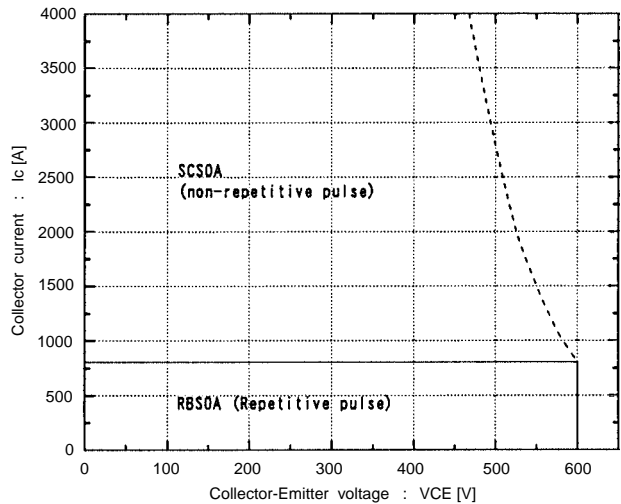

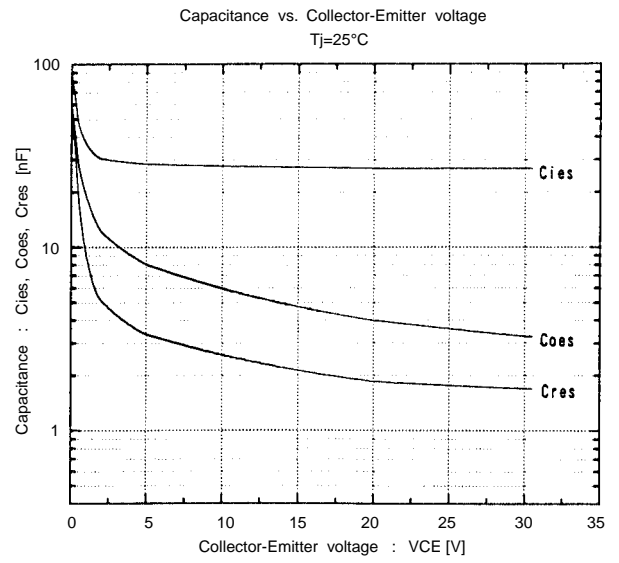
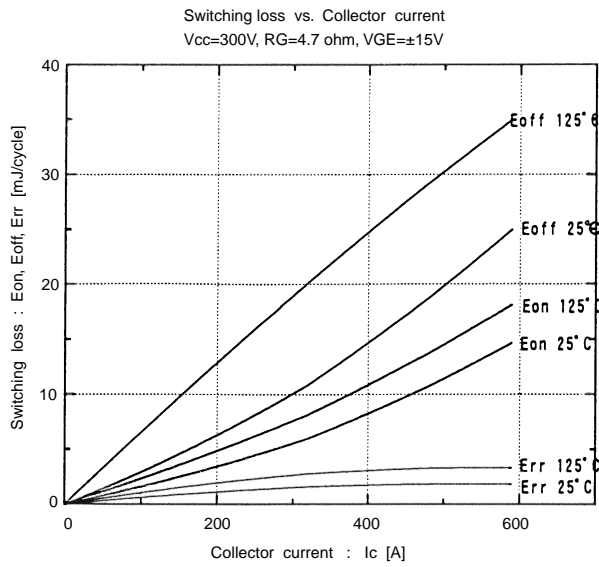

■ Outline Drawings, mm

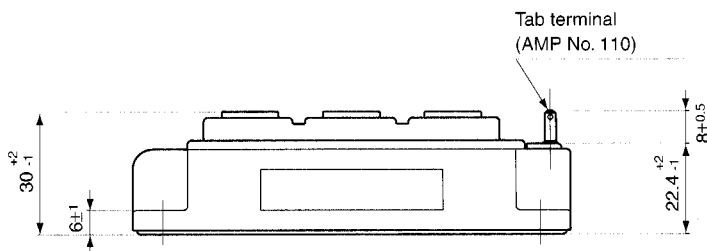
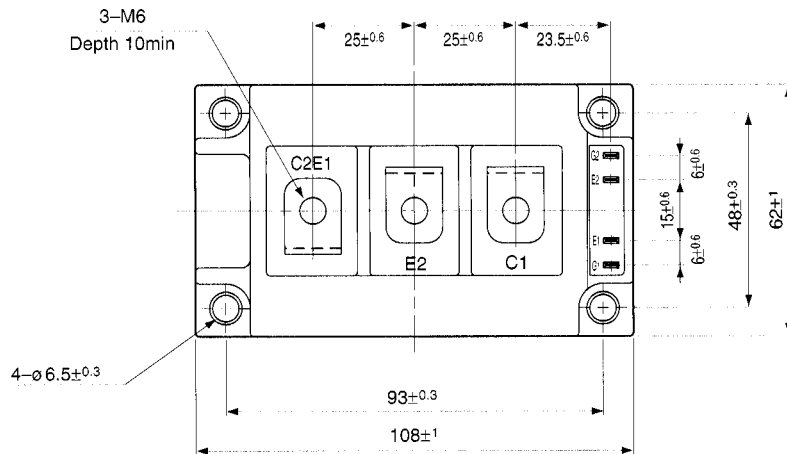

Mass : 370g