

# SPECIFICATION

Device Name : IGBT Module

Type Name : 2MBI400TB-060

Spec. No. : MS5F 5293

This material and the information herein is the property of Fuji Electric Co., Ltd. They shall be neither reproduced, copied, lent, or disclosed in any way whatsoever for the use of any third party nor used for the manufacturing purposes without the express written consent of Fuji Electric Co., Ltd.

Fuji Electric Co., Ltd.  
Matsumoto Factory

	DATE	NAME	APPROVED	<b>Fuji Electric Co., Ltd.</b>			
DRAWN	Oct- 22-'02	Y.Kobayashi	T.Fujihira	DWG.NO.	MS5F 5293	1	
CHECKED	Oct- 23-'02	T.Miyasaka				14	a
		K.Yamada				c	

# Revised Records

Date	Classification	Ind.	Content	Applied date	Drawn	Checked	Approved
Oct.-23-'02	enactment	—	—	Issued date	—	T.Miyasaka K.Yamada	T.Fujihira
Nov.-29-'02	Revision	a	Revised Reliability test condition (P7/14)		Y.Kobayashi	T.Miyasaka K.Yamada	T.Fujihira
Jan.-31-'03	Revision	b	Revised characteristics curve up to 800A (P11/14, 12/14)		Y.Kobayashi	T.Miyasaka K.Yamada	T.Fujihira
Apr.-07-'04	Revision	c	Revised ton, tr, toff, tf (P4/14) Revised Rth curve (P12/14)		Y.Kobayashi	T.Miyasaka K.Yamada	Y.Seki

This material and the information herein is the property of Fuji Electric Co., Ltd. They shall be neither reproduced, copied, lent, or disclosed in any way whatsoever for the use of any third party, nor used for the manufacturing purposes without the express written consent of Fuji Electric Co., Ltd.

# 2MBI400TB-060

## 1. Outline Drawing ( Unit : mm )

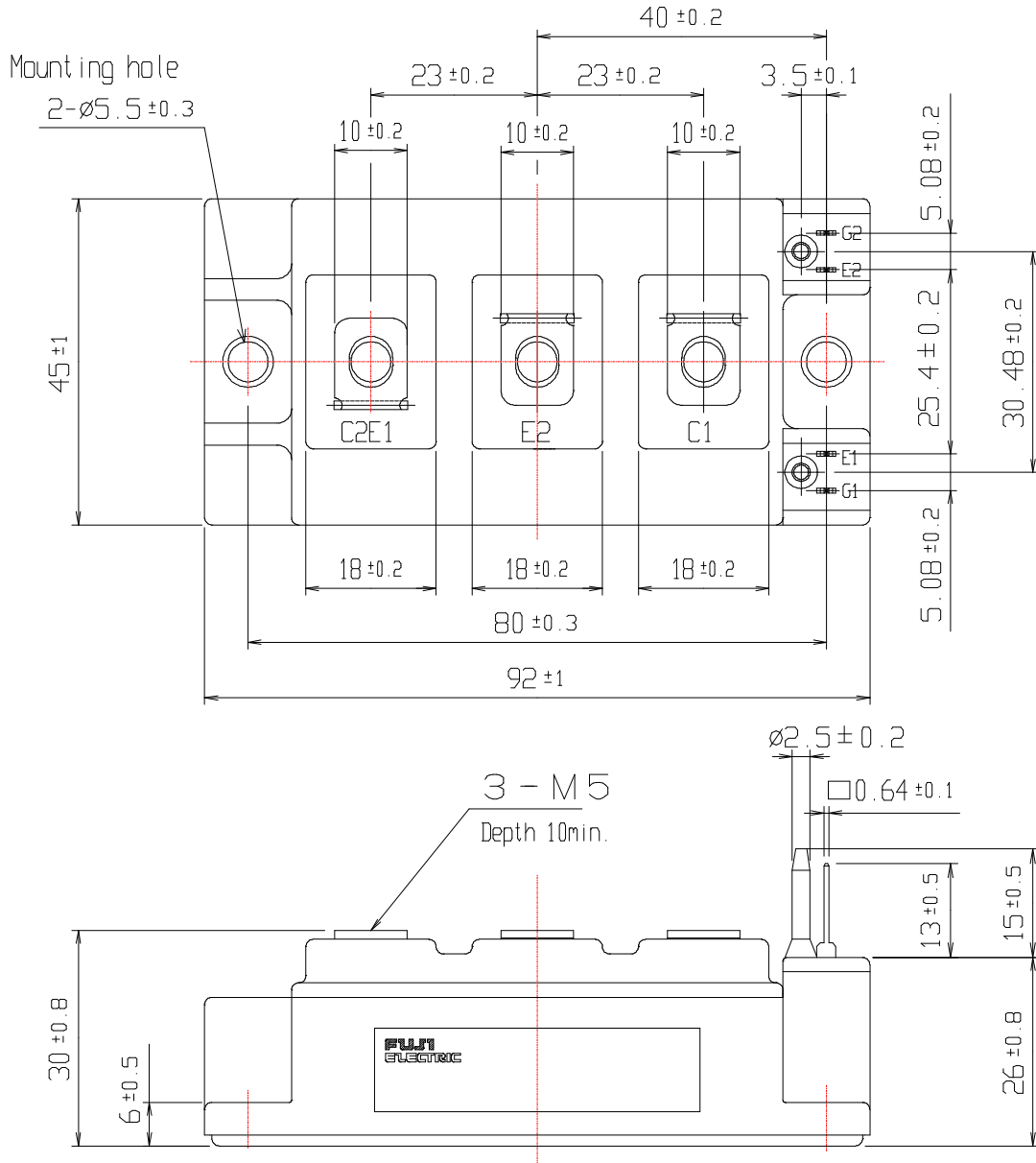

## 2. Equivalent circuit

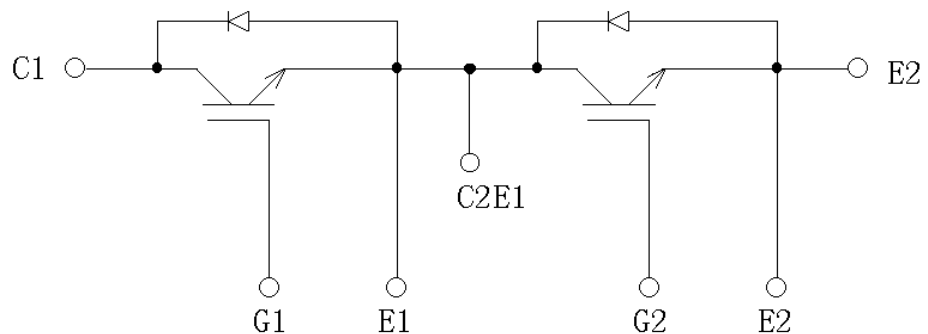

Fuji Electric Co.,Ltd.

DWG.NO.

MS5F 5293

3 / 14

a	
b	
c	

H04-004-03

This material and the information herein is the property of Fuji Electric Co., Ltd. They shall be neither reproduced, copied, lent, or disclosed in any way whatsoever for the use of any third party, nor used for the manufacturing purposes without the express written consent of Fuji Electric Co., Ltd.

3. Absolute Maximum Ratings ( at Tc= 25°C unless otherwise specified )

Items	Symbols	Conditions	Maximum Ratings	Units
Collector-Emitter voltage	V <sub>CE</sub> S	I <sub>c</sub> =1mA	600	V
Gate-Emitter voltage	V <sub>GE</sub> S		±20	V
Collector current	I <sub>c</sub>	Duty=100 %	400	A
	I <sub>c</sub> pulse	1ms	800	
	I <sub>F</sub>	Duty=56 %	400	
	I <sub>F</sub> pulse	1ms	800	
Collector Power Dissipation	P <sub>c</sub>	1 device	1270	W
Junction temperature	T <sub>J</sub>		150	°C
Storage temperature	T <sub>stg</sub>		-40~ +125	°C
Isolation voltage <sup>(*1)</sup>	Viso	AC : 1min.	2500	V
Screw Torque	Mounting <sup>(*2)</sup>		3.5	N.m
	Terminals <sup>(*2)</sup>		3.5	

(\*1) All terminals should be connected together when isolation test will be done.

(\*2) Recommendable Value : Mounting 2.5~3.5 N.m (M5)

Terminal 2.5~3.5Nm (M5)

4. Electrical characteristics ( at T<sub>J</sub>= 25°C unless otherwise specified)

Items	Symbols	Conditions	Characteristics			Units	
			min.	typ.	Max.		
Zero gate voltage Collector current	I <sub>CE</sub> S	V <sub>GE</sub> = 0 V, V <sub>CE</sub> = 600 V	-	-	2.0	mA	
Gate-Emitter leakage current	I <sub>GES</sub>	V <sub>CE</sub> = 0 V, V <sub>GE</sub> = ±20 V	-	-	400	nA	
Gate-Emitter threshold voltage	V <sub>GE(th)</sub>	V <sub>CE</sub> = 20 V, I <sub>c</sub> = 400 mA	6.2	6.7	7.7	V	
Collector-Emitter saturation voltage	V <sub>CE(sat)</sub>	V <sub>GE</sub> = 15 V	-	1.9	-	V	
		I <sub>c</sub> = 400 A					Chip
Input capacitance	C <sub>ies</sub>	V <sub>GE</sub> = 0 V	-	30000	-	pF	
Output capacitance	C <sub>oes</sub>	V <sub>CE</sub> = 10 V	-	5200	-		
Reverse transfer capacitance	C <sub>res</sub>	f = 1 MHz	-	4500	-		
Turn-on time	ton	V <sub>cc</sub> = 300 V	-	° 0.4	1.2	μs	
	tr	I <sub>c</sub> = 400 A	-	° 0.2	0.6		
	tr <sub>(t)</sub>	V <sub>GE</sub> = ±15 V	-	0.1	-		
Turn-off time	toff	R <sub>G</sub> = 6.8 Ω	-	° 0.55	1.2	μs	
	tf		-	° 0.05	0.45		
Forward on voltage	V <sub>F</sub>	I <sub>F</sub> = 400 A	Chip	-	1.75	-	V
			Terminal	-	1.9	2.5	
Reverse recovery time	trr	I <sub>F</sub> = 400 A	-	-	0.3	μs	
Allowable avalanche energy during short circuit cutting off (Non-repetitive)	PAV	I <sub>c</sub> > 800A, T <sub>J</sub> = 125°C	200	-	-	mJ	

5. Thermal resistance characteristics

Items	Symbols	Conditions	Characteristics			Units
			min.	typ.	Max.	
Thermal resistance (1 device)	R <sub>th(j-c)</sub>	IGBT	-	-	0.098	°C/w
		FWD	-	-	0.19	
Contact Thermal resistance	R <sub>th(c-f)</sub>	With thermal compound *	-	0.025	-	

\* This is the value which is defined mounting on the additional cooling fin with thermal compound.

6. Indication on module

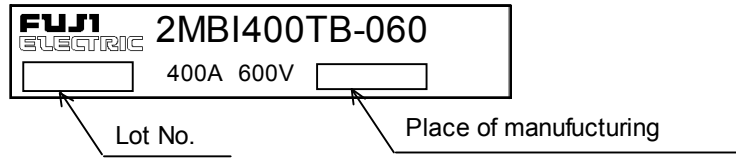

7. Applicable category

This specification is applied to IGBT Module named 2MBI400TB-060

8. Storage and transportation notes

- The module should be stored at a standard temperature of 5 to 35C and humidity of 45 to 75% .
- Store modules in a place with few temperature changes in order to avoid condensation on the module surface.
- Avoid exposure to corrosive gases and dust.
- Avoid excessive external force on the module.
- Store modules with unprocessed terminals.
- Do not drop or otherwise shock the modules when transporting.

9. Definitions of switching time

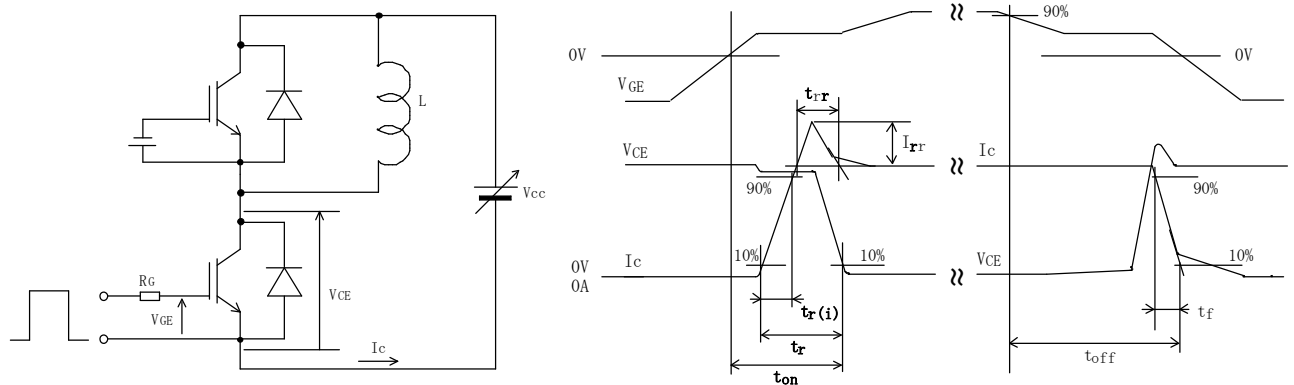

This material and the information herein is the property of Fuji Electric Co., Ltd. They shall be neither reproduced, copied, lent, or disclosed in any way whatsoever for the use of any third party, nor used for the manufacturing purposes without the express written consent of Fuji Electric Co., Ltd.

This material and the information herein is the property of Fuji Electric Co., Ltd. They shall be neither reproduced, copied, lent, or disclosed in any way whatsoever for the use of any third party, nor used for the manufacturing purposes without the express written consent of Fuji Electric Co., Ltd.

10. Definition of the allowable avalanche energy during short circuit cutting of.

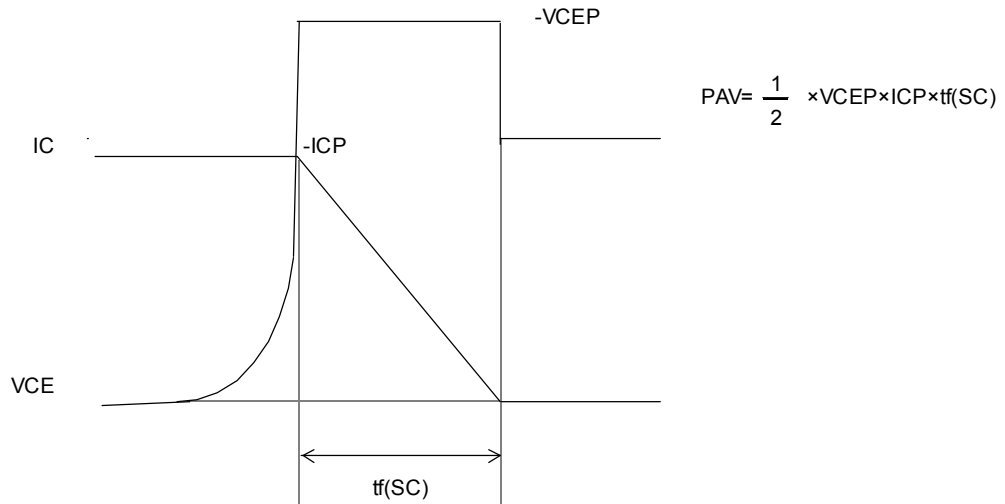

11. UL recognition

This products is recognized by Underwriters Laboratories Inc., the file No. is E82988.

12. Packing and Labeling

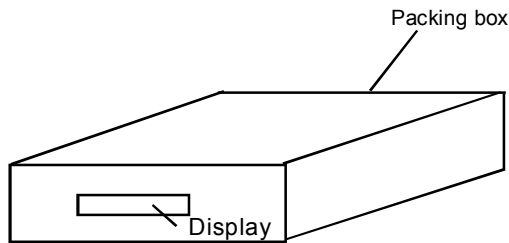

Display on the packing box

- Logo of production
- Type name
- Lot No.
- Products quantity in a packing box

\* Each modules are packed with electrical protection.

13. Reliability test results

**Reliability Test Items**

Test categories	Test items	Test methods and conditions	Reference norms EIAJ ED-4701	Number of sample	Acceptance number
Mechanical Tests	1 Terminal Strength (Pull test)	Pull force : <sup>a</sup> 40N Test time : 10±1 sec.	A - 111 Method 1	5	(1 : 0)
	2 Mounting Strength	Screw torque : 2.5 ~ 3.5 N·m (M5) Test time : 10±1 sec.	A - 112 Method 2	5	(1 : 0)
	3 Vibration	Range of frequency : 10 ~ 500Hz Sweeping time : 15 min. Acceleration : <sup>a</sup> 10G Sweeping direction : Each X,Y,Z axis Test time : 6 hr. (2hr./direction)	A - 121	5	(1 : 0)
	4 Shock	Maximum acceleration : 1000G Pulse width : 0.5msec. Direction : Each X,Y,Z axis Test time : 3 times/direction	A - 122	5	(1 : 0)
Environment Tests	1 High Temperature Storage	Storage temp. : 125±5 °C Test duration : 1000hr.	B - 111	5	(1 : 0)
	2 Low Temperature Storage	Storage temp. : -40±5 °C Test duration : 1000hr.	B - 112	5	(1 : 0)
	3 Temperature Humidity Storage	Storage temp. : 85±3 °C Relative humidity : 85±5% Test duration : 1000hr.	B - 121	5	(1 : 0)
	4 Unsaturated Pressure Cooker	Test temp. : 121 °C Atmospheric pressure : 2.03×10 <sup>5</sup> Pa (Reference value) Test duration : 20hr.	B - 123	5	(1 : 0)
	5 Temperature Cycle	Test temp. : $\begin{cases} \text{Low temp. } -40^{+3-5} \text{ } ^\circ\text{C} \\ \text{High temp. } 125^{+5-5} \text{ } ^\circ\text{C} \\ \text{RT } 5 \sim 35 \text{ } ^\circ\text{C} \end{cases}$ Dwell time : High ~ RT ~ Low ~ RT 1hr. 0.5hr. 1hr. 0.5hr. Number of cycles : 100 cycles	B - 131	5	(1 : 0)
	6 Thermal Shock	Test temp. : $\begin{cases} \text{High temp. } 100^{+0-5} \text{ } ^\circ\text{C} \\ \text{Low temp. } 0^{+5-0} \text{ } ^\circ\text{C} \end{cases}$ Used liquid : Water with ice and <sup>a</sup> boiling water Dipping time : 5 min. par each temp. Transfer time : 10 sec. Number of cycles : 10 cycles	B - 141	5	(1 : 0)

This material and the information herein is the property of Fuji Electric Co., Ltd. They shall be neither reproduced, copied, lent, or disclosed in any way whatsoever for the use of any third party, nor used for the manufacturing purposes without the express written consent of Fuji Electric Co., Ltd.

## Reliability Test Items

Test categories	Test items	Test methods and conditions	Reference norms EIAJ ED-4701	Number of sample	Acceptance number
Endurance Tests	1 High temperature Reverse Bias	Test temp. : $T_a = 125^{+0}_{-5} \text{ } ^\circ\text{C}$ $(T_j \leq 150 \text{ } ^\circ\text{C})$ Bias Voltage : $V_C = 0.8 \times V_{CES}$ Bias Method : Applied DC voltage to C-E $V_{GE} = 0V$ Test duration : 1000hr.	D - 313	5	( 1 : 0 )
	2 High temperature Bias	Test temp. : $T_a = 125^{+0}_{-5} \text{ } ^\circ\text{C}$ $(T_j \leq 150 \text{ } ^\circ\text{C})$ Bias Voltage : $V_C = V_{GE} = +20V \text{ or } -20V$ Bias Method : Applied DC voltage to G-E $V_{CE} = 0V$ Test duration : 1000hr.	D - 323	5	( 1 : 0 )
	3 Temperature Humidity Bias	Test temp. : $85 \pm 3 \text{ } ^\circ\text{C}$ Relative humidity : $85 \pm 5\%$ Bias Voltage : $V_C = 0.8 \times V_{CES}$ Bias Method : Applied DC voltage to C-E $V_{GE} = 0V$ Test duration : 1000hr.	B - 121	5	( 1 : 0 )
	4 Intermitted Operating Life (Power cycle) ( for IGBT )	ON time : 2 sec. OFF time : 18 sec. Test temp. : $\Delta T_j = 100 \pm 5 \text{ deg}$ $T_j \leq 150 \text{ } ^\circ\text{C}, T_a = 25 \pm 5 \text{ } ^\circ\text{C}$ Number of cycles : 15000 cycles	D - 322	5	( 1 : 0 )

## Failure Criteria

Item	Characteristic	Symbol	Failure criteria		Unit	Note	
			Lower limit	Upper limit			
Electrical characteristic	Leakage current	ICES	-	USL×2	mA		
		±IGES	-	USL×2	μA		
	Gate threshold voltage	VGE(th)	LSL×0.8	USL×1.2	mA		
	Saturation voltage	VCE(sat)	-	USL×1.2	V		
	Forward voltage	VF	-	USL×1.2	V		
	Thermal resistance	IGBT	Δ VGE	-	USL×1.2	mV	
			or Δ VCE				
	FWD	Δ VF	-	USL×1.2	mV		
	Isolation voltage	Viso	Broken insulation		-		
Visual inspection	Visual inspection Peeling Plating and the others	-	The visual sample		-		

LSL : Lower specified limit.

USL : Upper specified limit.

Note : Each parameter measurement read-outs shall be made after stabilizing the components at room ambient for 2 hours minimum, 24 hours maximum after removal from the tests. And in case of the wetting tests, for example, moisture resistance tests, each component shall be made wipe or dry completely before the measurement.

This material and the information herein is the property of Fuji Electric Co., Ltd. They shall be neither reproduced, copied, lent, or disclosed in any way whatsoever for the use of any third party, nor used for the manufacturing purposes without the express written consent of Fuji Electric Co., Ltd.



## Reliability Test Results

Test categories	Test items	Reference norms EIAJ ED-4701	Number of test sample	Number of failure sample
Mechanical Tests	1 Terminal Strength (Pull test)	A - 111 Method 1	5	0
	2 Mounting Strength	A - 112 Method 2	5	0
	3 Vibration	A - 121	5	0
	4 Shock	A - 122	5	0
Environment Tests	1 High Temperature Storage	B - 111	5	0
	2 Low Temperature Storage	B - 112	5	0
	3 Temperature Humidity Storage	B - 121	5	0
	4 Unsaturated Pressure Cooker	B - 123	5	0
	5 Temperature Cycle	B - 131	5	0
	6 Thermal Shock	B - 141	5	0
Endurance Tests	1 High temperature Reverse Bias	D - 313	5	0
	2 High temperature Bias ( for gate )	D - 323	5	0
	3 Temperature Humidity Bias	B - 121	5	0
	4 Intermitted Operating Life (Power cycling) ( for IGBT )	D - 322	5	0

This material and the information herein is the property of Fuji Electric Co., Ltd. They shall be neither reproduced, copied, lent, or disclosed in any way whatsoever for the use of any third party, nor used for the manufacturing purposes without the express written consent of Fuji Electric Co., Ltd.

This material and the information herein is the property of Fuji Electric Co., Ltd. They shall be neither reproduced, copied, lent, or disclosed in any way whatsoever for the use of any third party, nor used for the manufacturing purposes without the express written consent of Fuji Electric Co., Ltd.

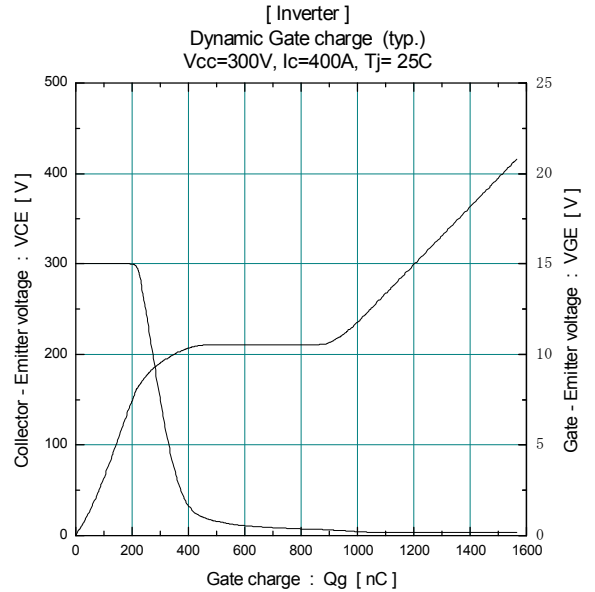
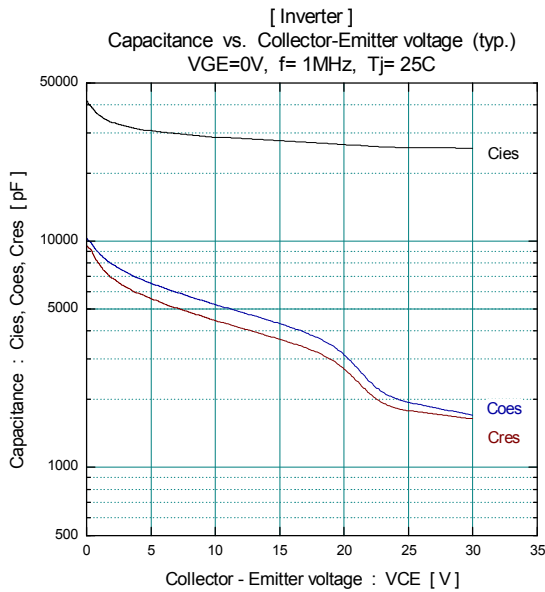
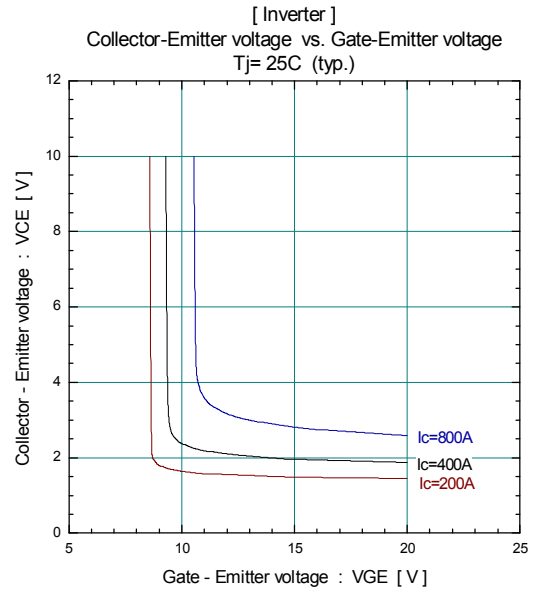
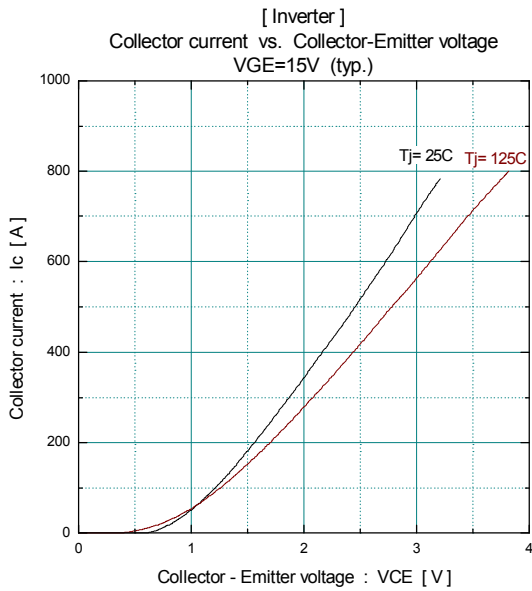
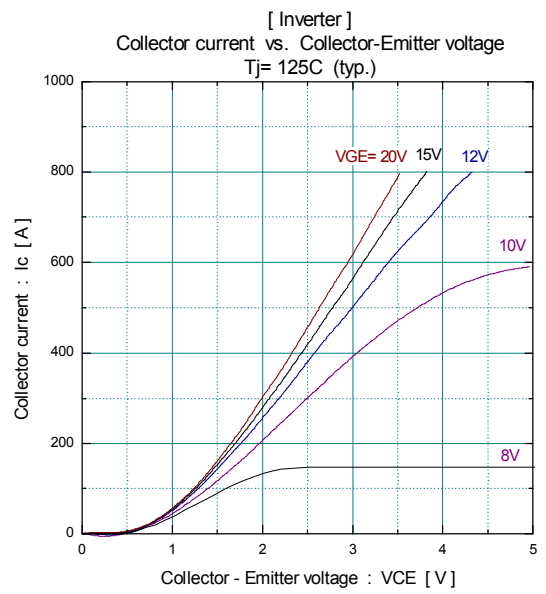
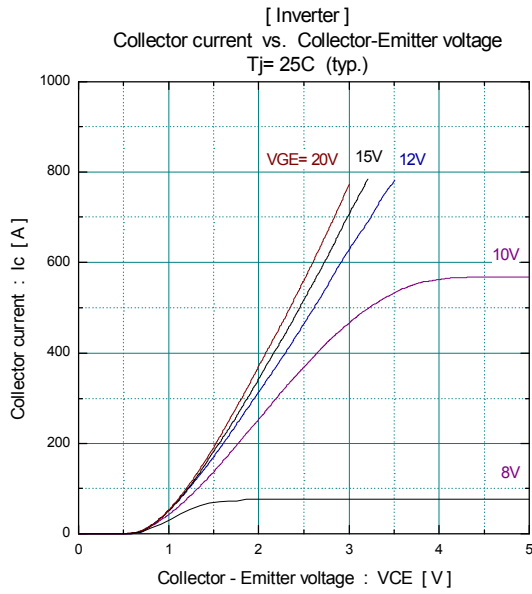

This material and the information herein is the property of Fuji Electric Co., Ltd. They shall be neither reproduced, copied, lent, or disclosed in any way whatsoever for the use of any third party, nor used for the manufacturing purposes without the express written consent of Fuji Electric Co., Ltd.

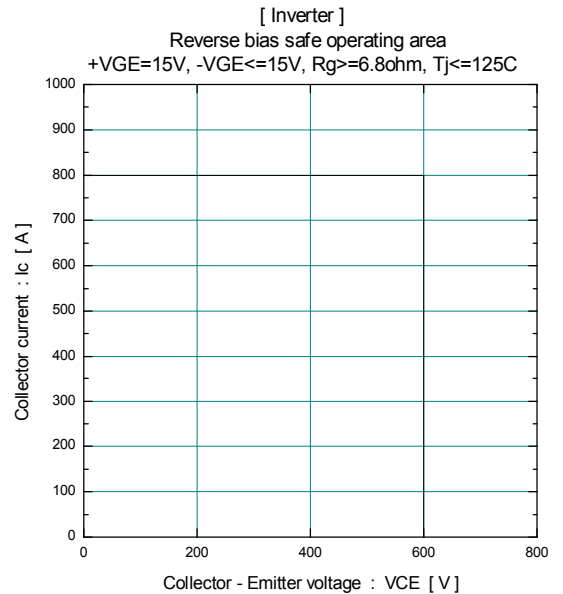
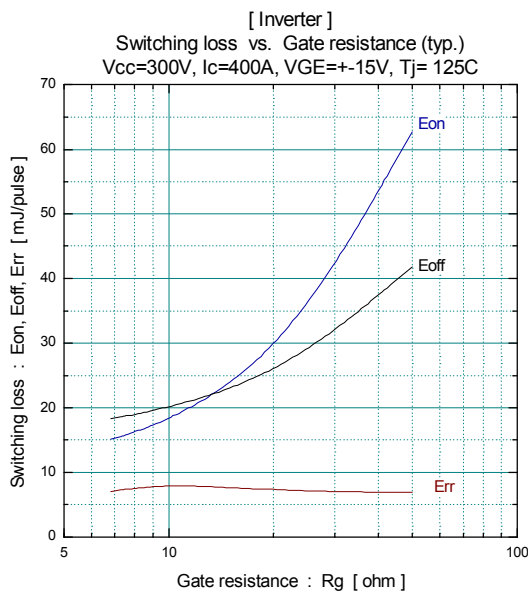
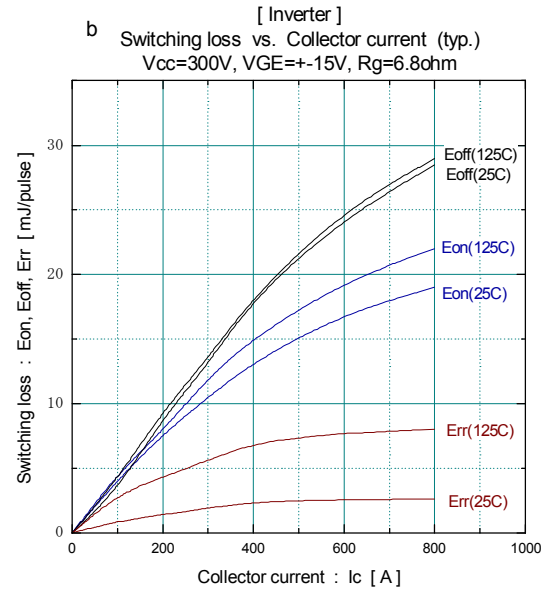
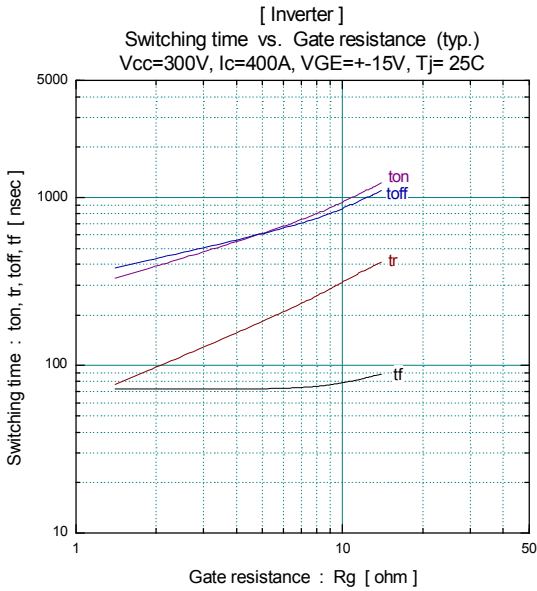
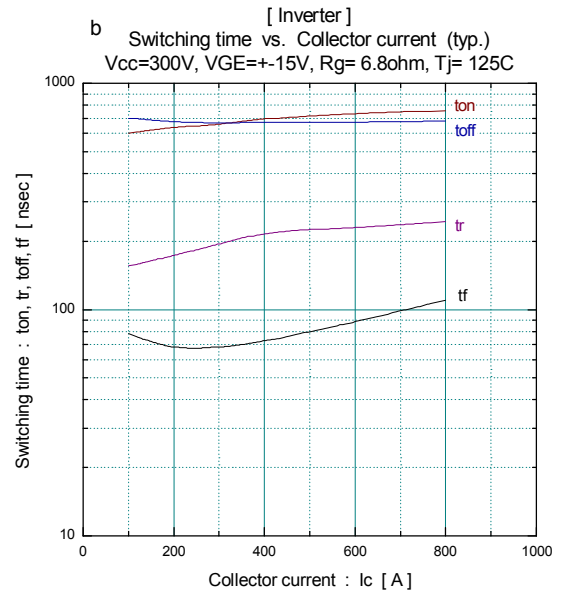
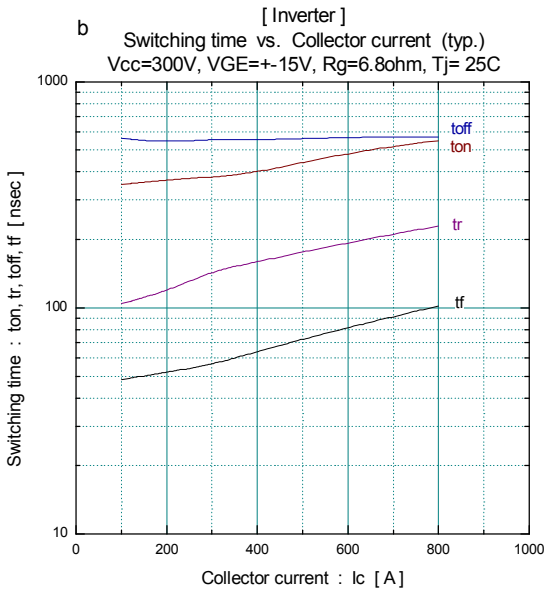

This material and the information herein is the property of Fuji Electric Co., Ltd. They shall be neither reproduced, copied, lent, or disclosed in any way whatsoever for the use of any third party, nor used for the manufacturing purposes without the express written consent of Fuji Electric Co., Ltd.

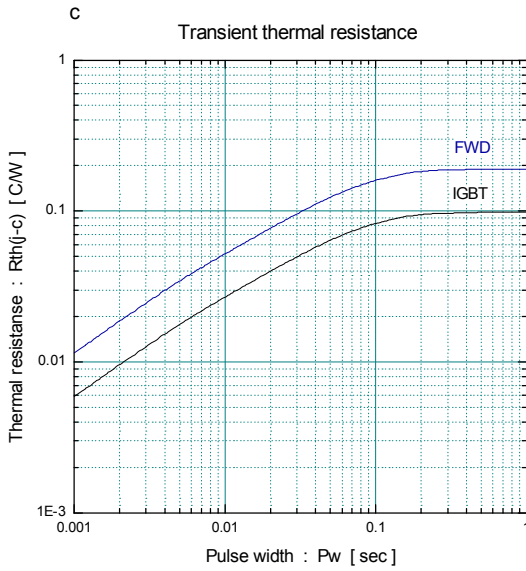
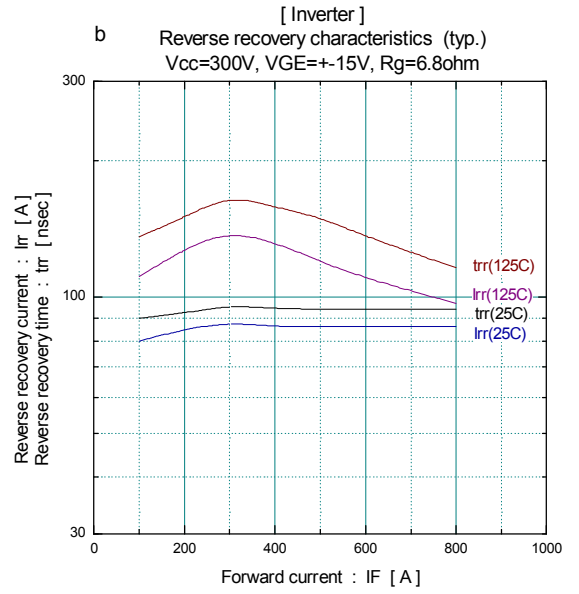
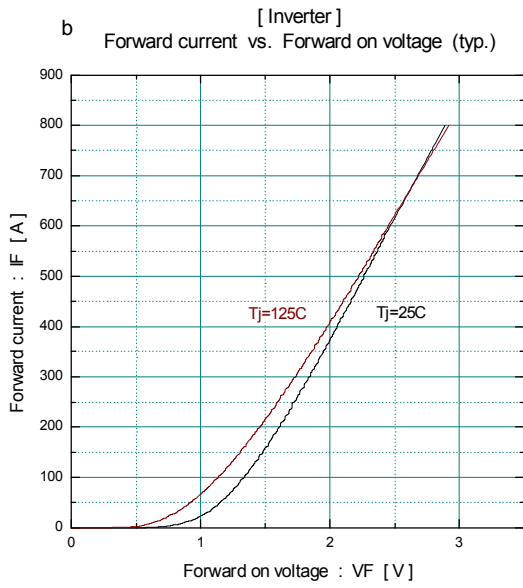

## Warnings

- This product shall be used within its absolute maximum rating (voltage, current, and temperature).  
This product may be broken in case of using beyond the ratings.  
製品の絶対最大定格(電圧, 電流, 温度等)の範囲内で御使用下さい。  
絶対最大定格を超えて使用すると、素子が破壊する場合があります。
- Connect adequate fuse or protector of circuit between three-phase line and this product to prevent the equipment from causing secondary destruction.  
万一の不慮の事故で素子が破壊した場合を考慮し、商用電源と本製品の間に適切な容量のヒューズ又はブレーカーを必ず付けて2次破壊を防いでください。
- Use this product after realizing enough working on environment and considering of product's reliability life.  
This product may be broken before target life of the system in case of using beyond the product's reliability life.  
製品の使用環境を十分に把握し、製品の信頼性寿命が満足できるか検討の上、本製品を適用して下さい。  
製品の信頼性寿命を超えて使用した場合、装置の目標寿命より前に素子が破壊する場合があります。
- If the product had been used in the environment with acid, organic matter, and corrosive gas (hydrogen sulfide, sulfurous acid gas), the product's performance and appearance can not be ensured easily.  
酸・有機物・腐食性ガス(硫化水素, 亜硫酸ガス等)を含む環境下で使用された場合、製品機能・外観などの保証は致しかねます。
- Use this product within the power cycle curve(Technical Rep.No:MT6M4057)  
本製品は、パワーサイクル寿命カーブ以下で使用下さい(技術資料No.:MT6M4057)
- Never add mechanical stress to deform the main or control terminal.  
The deformed terminal may cause poor contact problem.  
主端子及び制御端子に応力を与えて変形させないで下さい。端子の変形により、接触不良などを引き起こす場合があります。
- According to the outline drawing, select proper length of screw for main terminal.  
Longer screws may break the case.  
本製品に使用する主端子用のネジの長さは、外形図に従い正しく選定下さい。  
ネジが長いとケースが破損する場合があります。
- Use this product with keeping the cooling fin's flatness between screw holes within 100um and the roughness within 10um. Also keep the tightening torque within the limits of this specification.  
Improper handling may cause isolation breakdown and this may lead to a critical accident.  
冷却フィンにネジ取り付け位置間で平坦度を100um以下、表面の粗さは10um以下にして下さい。誤った取り扱いをすると絶縁破壊を起こし、重大事故に発展する場合があります。
- It shall be confirmed that IGBT's operating locus of the turn-off voltage and current are within the RBSOA specification. This product may be broken if the locus is out of the RBSOA.  
ターンオフ電圧・電流の動作軌跡がRBSOA仕様内にあることを確認して下さい。  
RBSOAの範囲を超えて使用すると素子が破壊する可能性があります。
- If excessive static electricity is applied to the control terminals, the devices can be broken.  
Implement some countermeasures against static electricity.  
制御端子に過大な静電気が印加された場合、素子が破壊する場合があります。  
取り扱い時は静電気対策を実施して下さい。

This material and the information herein is the property of Fuji Electric Co., Ltd. They shall be neither reproduced, copied, lent, or disclosed in any way whatsoever for the use of any third party, nor used for the manufacturing purposes without the express written consent of Fuji Electric Co., Ltd.

This material and the information herein is the property of Fuji Electric Co., Ltd. They shall be neither reproduced, copied, lent, or disclosed in any way whatsoever for the use of any third party, nor used for the manufacturing purposes without the express written consent of Fuji Electric Co., Ltd.

## Cautions

- Fuji Electric is constantly making every endeavor to improve the product quality and reliability. However, semiconductor products may rarely happen to fail or malfunction. To prevent accidents causing injury or death, damage to property like by fire, and other social damage resulted from a failure or malfunction of the Fuji Electric semiconductor products, take some measures to keep safety such as redundant design, spread-fire-preventive design, and malfunction-protective design.  
富士電機は耐えず製品の品質と信頼性の向上に努めています。しかし、半導体製品は故障が発生したり、誤動作する場合があります。富士電機製半導体製品の故障または誤動作が、結果として人身事故・火災等による財産に対する損害や社会的な損害を起こさないように冗長設計・延焼防止設計・誤動作防止設計など安全確保のための手段を講じて下さい。
- The application examples described in this specification only explain typical ones that used the Fuji Electric products. This specification never ensure to enforce the industrial property and other rights, nor license the enforcement rights.  
本仕様書に記載してある応用例は、富士電機製品を使用した代表的な応用例を説明するものであり、本仕様書によって工業所有権、その他権利の実施に対する保障または実施権の許諾を行うものではありません。
- The product described in this specification is not designed nor made for being applied to the equipment or systems used under life-threatening situations. When you consider applying the product of this specification to particular used, such as vehicle-mounted units, shipboard equipment, aerospace equipment, medical devices, atomic control systems and submarine relaying equipment or systems, please apply after confirmation of this product to be satisfied about system construction and required reliability.  
本仕様書に記載された製品は、人命にかかわるような状況下で使用される機器あるいはシステムに用いられることを目的として設計・製造されたものではありません。本仕様書の製品を車両機器、船舶、航空宇宙、医療機器、原子力制御、海底中継機器あるいはシステムなど、特殊用途へのご利用をご検討の際は、システム構成及び要求品質に満足することをご確認の上、ご利用下さい。

If there is any unclear matter in this specification, please contact Fuji Electric Co.,Ltd.