

Power Transistors

**2N1487 2N1488
2N1489 2N1490**

RCA-2N1487-2N1490 are diffused-junction power transistors of the silicon n-p-n type. These transistors are intended for a wide variety of applications in industrial and military equipment. They are particularly useful in power-switching circuits such as in dc-to-dc converters, inverters, choppers, solenoid and relay controls; in oscillator, regulator, and pulse-amplifier circuits; and as class-A and class-B push-pull audio and servo amplifiers.

These transistors feature high power-dissipation ratings, high beta at high current, and excellent high temperature performance.

High-Power Types

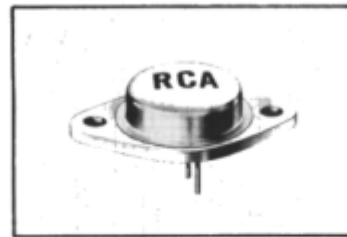

JEDEC TO-3

- Maximum dissipation rating of 75 watts at a mounting flange temperature of 25°C
- 2N1489 and 2N1490 have a maximum saturation resistance of 0.67 ohm

Maximum Ratings, Absolute-Maximum Values:

	2N1487	2N1488		
	2N1489	2N1490		
COLLECTOR-TO-BASE VOLTAGE	60	100	max.	volts
COLLECTOR-TO-EMITTER VOLTAGE:				
With base open (sustaining voltage)	40	55	max.	volts
With emitter-to-base reverse				
biased ($V_{EB} = 1.5$ volts)	60	100	max.	volts
EMITTER-TO-BASE VOLTAGE	10	10	max.	volts
COLLECTOR CURRENT	6	6	max.	amp
EMITTER CURRENT	-8	-8	max.	amp
BASE CURRENT	3	3	max.	amp
TRANSISTOR DISSIPATION:				
(See Rating Chart Fig. 1):				
At mounting-flange temperature of 25°C	75	75	max.	watts
At mounting-flange temperature of 100°C	43	43	max.	watts
TEMPERATURE RANGE:				
Operating and Storage	-65 to +200			°C



ELECTRICAL CHARACTERISTICS

Mounting-flange temperature = 25°C unless otherwise specified.

Characteristic	Symbol	TEST CONDITIONS					LIMITS								Units
		DC Collector Voltage (volts)		DC Emitter Voltage (volts)	DC Collector Current (ma)	DC Base Current (ma)	Type 2N1487		Type 2N1488		Type 2N1489		Type 2N1490		
		V _{CB}	V _{CE}	V _{EB}	I _C	I _B	Min.	Max.	Min.	Max.	Min.	Max.	Min.	Max.	
Collector-Cutoff Current: With I _E = 0 and at mounting flange temperature of: 25°C 150°C	I _{CBO}		30 30					25 1000	25 1000	25 1000	25 1000			μa μa	
Emitter-Cutoff Current	I _{EBO}			10	0			25	25	25	25			μa	
Collector-To-Emitter Voltage: (Emitter-to-base reverse bias) (Base open sustaining voltage)	V _{CEx} V _{CE0} (sus)			1.5	0.5		60	100	60	100				volts volts	
DC Current Transfer Ratio	h _{FE}		4		1.5amps		15	45	15	45	25	75	25	75	
DC Collector-To-Emitter Saturation Resistance	I _{CE(sat)}				1.5amps 1.5amps	300 100		2	2		0.67	0.67		ohms ohm	
Base-To-Emitter Voltage	V _{BE}		4		1.5amps		3.5	3.5	2.5	2.5				volts	
Thermal Resistance: Junction-to-mounting flange	R _{θJC}						2.33	2.33	2.33	2.33				°C/w	

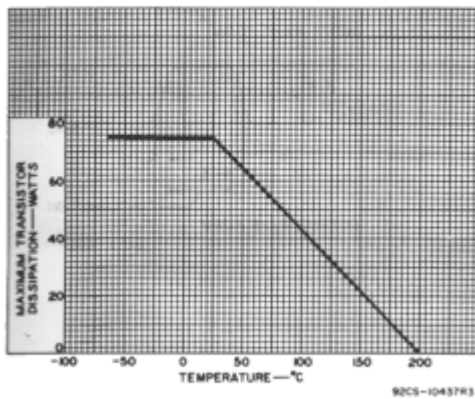

Fig. 1 - Rating Chart for Types 2N1487, 2N1488, 2N1489, and 2N1490.

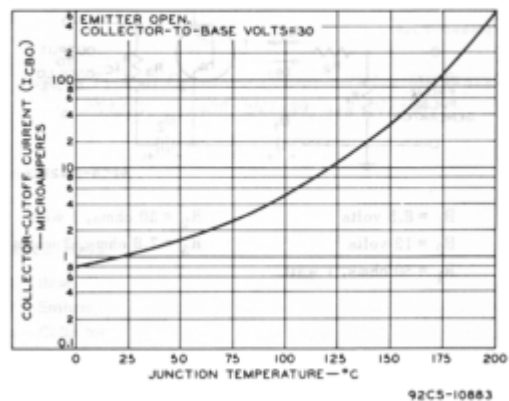

Fig. 2 - Typical Operation Characteristics for Types 2N1487, 2N1488, 2N1489, and 2N1490.



RCA	Transistor 2N1487	Datasheet
-----	-------------------	-----------

Typical Operation of the 2N1487, 2N1488, 2N1489, and 2N1490 in the Power-Switching Circuit of Fig. 3:

DC Supply Voltage (B_2)	12	volts
DC Base Bias Voltage (B_1)	-8.5	volts
Generator Resistance	50	ohms
"On" DC Collector Current	1.5	amp
"Turn-On" Base Current (I_{B1})	300	ma
"Turn-Off" Base Current (I_{B2})	-150	ma
Switching Time:		
Delay Time (t_d)	0.2	μ sec
Rise Time (t_r)	1.0	μ sec
Storage Time (t_s)	1.0	μ sec
Fall Time (t_f)	1.2	μ sec

Typical Characteristics of the 2N1487, 2N1488, 2N1489, and 2N1490 at a Mounting-Flange Temperature of 25°C:

Collector-to-base capacitance: C_{ob}		
($V_{CB} = 40$ volts)	200	μ f
Thermal Time Constant, τ_1	12	msec
Alpha-Cutoff Frequency f_{ab}		
($V_{CB} = 12$ volts, $I_c = 100$ ma)	1	Mc

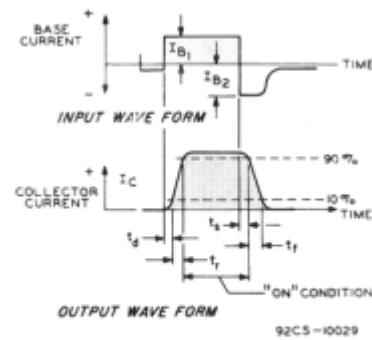
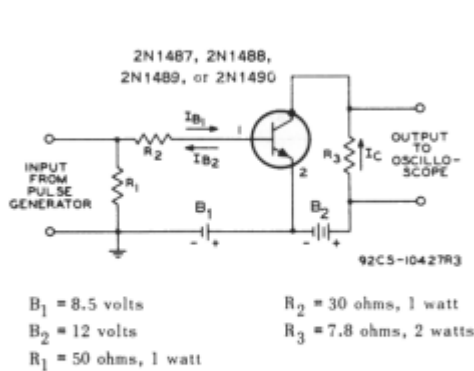

Fig. 3 - Typical Power-Switching Circuit.



File No. 139

2N1487-2N1490

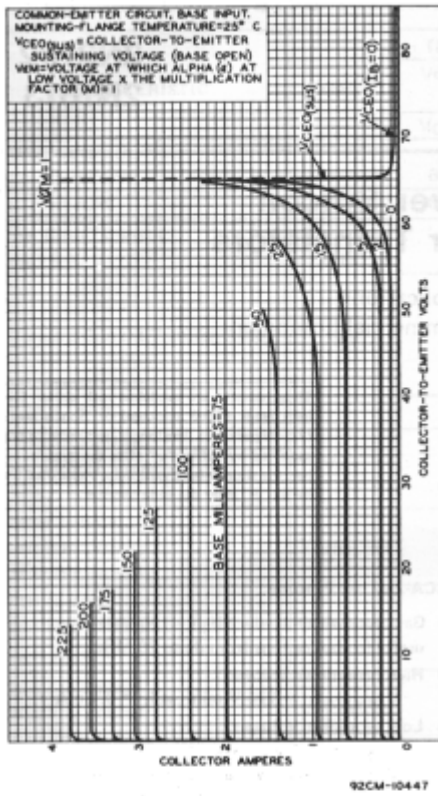

Fig. 4 - Typical Collector Characteristics for Types
2N1487, 2N1488, 2N1489, and 2N1490.

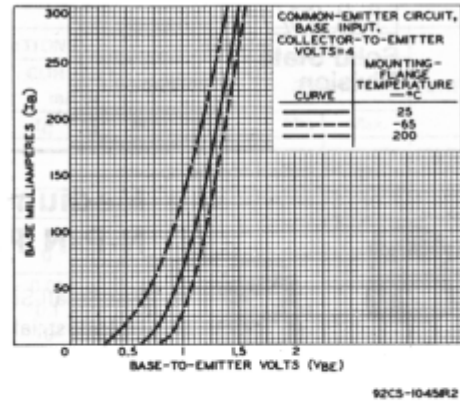

Fig. 5 - Typical Input Characteristics for Types
2N1487, 2N1488, 2N1489, and 2N1490.

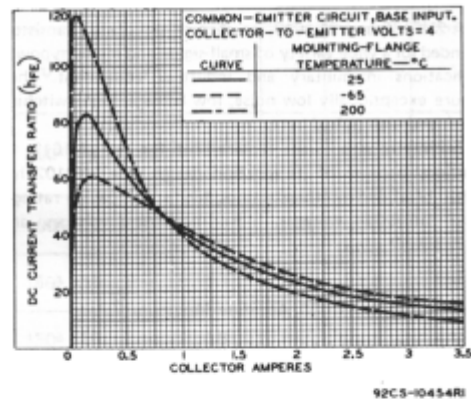

Fig. 6 - Typical Operation Characteristics for Types
2N1487, 2N1488, 2N1489, and 2N1490.

TERMINAL CONNECTIONS

Pin 1 - Base
Pin 2 - Emitter
Case - Collector
Mounting Flange - Collector

