

2N3055AG (NPN), MJ15015G (NPN), MJ15016G (PNP)

Complementary Silicon High-Power Transistors

These PowerBase complementary transistors are designed for high power audio, stepping motor and other linear applications. These devices can also be used in power switching circuits such as relay or solenoid drivers, dc-to-dc converters, inverters, or for inductive loads requiring higher safe operating area than the 2N3055.

Features

- High Current-Gain – Bandwidth
- Safe Operating Area
- These Devices are Pb-Free and are RoHS Compliant*

MAXIMUM RATINGS (Note 1)

Rating	Symbol	Value	Unit
Collector-Emitter Voltage 2N3055AG MJ15015G, MJ15016G	V_{CEO}	60 120	Vdc
Collector-Base Voltage 2N3055AG MJ15015G, MJ15016G	V_{CBO}	100 200	Vdc
Collector-Emitter Voltage Base Reversed Biased 2N3055AG MJ15015G, MJ15016G	V_{CEV}	100 200	Vdc
Emitter-Base Voltage	V_{EBO}	7.0	Vdc
Collector Current – Continuous	I_C	15	Adc
Base Current	I_B	7.0	Adc
Total Device Dissipation @ $T_C = 25^\circ\text{C}$ 2N3055AG MJ15015G, MJ15016G Derate above 25°C 2N3055AG MJ15015G, MJ15016G	P_D	115 180 0.65 1.03	W W W/ $^\circ\text{C}$ W/ $^\circ\text{C}$
Operating and Storage Junction Temperature Range	T_J, T_{stg}	-65 to +200	$^\circ\text{C}$

Stresses exceeding Maximum Ratings may damage the device. Maximum Ratings are stress ratings only. Functional operation above the Recommended Operating Conditions is not implied. Extended exposure to stresses above the Recommended Operating Conditions may affect device reliability.

1. Indicates JEDEC Registered Data. (2N3055A)

THERMAL CHARACTERISTICS

Characteristics	Symbol	Max	Max	Unit
Thermal Resistance, Junction-to-Case	$R_{\theta JC}$	1.52	0.98	$^\circ\text{C}/\text{W}$

*For additional information on our Pb-Free strategy and soldering details, please download the ON Semiconductor Soldering and Mounting Techniques Reference Manual, SOLDERRM/D.



ON Semiconductor®

<http://onsemi.com>

15 AMPERE COMPLEMENTARY SILICON POWER TRANSISTORS 60, 120 VOLTS – 115, 180 WATTS

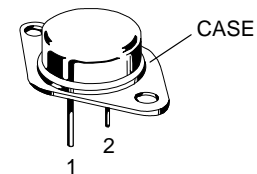
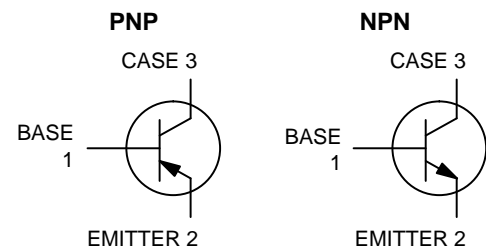

TO-204 (TO-3)
CASE 1-07
STYLE 1

MARKING DIAGRAMS

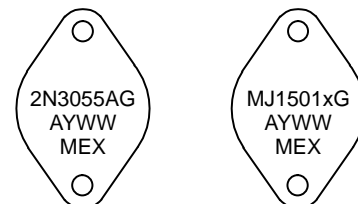

2N3055A = Device Code
MJ1501x = Device Code
x = 5 or 6
G = Pb-Free Package
A = Assembly Location
Y = Year
WW = Work Week
MEX = Country of Origin

ORDERING INFORMATION

See detailed ordering and shipping information in the package dimensions section on page 5 of this data sheet.

2N3055AG (NPN), MJ15015G (NPN), MJ15016G (PNP)

ELECTRICAL CHARACTERISTICS (T_C = 25°C unless otherwise noted)

Characteristic	Symbol	Min	Max	Unit
----------------	--------	-----	-----	------

OFF CHARACTERISTICS (Note 2)

Collector–Emitter Sustaining Voltage (Note 3) (I _C = 200 mAdc, I _B = 0)	2N3055AG MJ15015G, MJ15016G	V _{CEO(sus)}	60 120	– –	Vdc
Collector Cutoff Current (V _{CE} = 30 Vdc, V _{BE(off)} = 0 Vdc) (V _{CE} = 60 Vdc, V _{BE(off)} = 0 Vdc)	2N3055AG MJ15015G, MJ15016G	I _{CEO}	– –	0.7 0.1	mAdc
Collector Cutoff Current (Note 3) (V _{CEV} = Rated Value, V _{BE(off)} = 1.5 Vdc)	2N3055AG MJ15015G, MJ15016G	I _{CEV}	– –	5.0 1.0	mAdc
Collector Cutoff Current (V _{CEV} = Rated Value, V _{BE(off)} = 1.5 Vdc, T _C = 150°C)	2N3055AG MJ15015G, MJ15016G	I _{CEV}	– –	30 6.0	mAdc
Emitter Cutoff Current (V _{EB} = 7.0 Vdc, I _C = 0)	2N3055AG MJ15015G, MJ15016G	I _{EBO}	– –	5.0 0.2	mAdc

SECOND BREAKDOWN (Note 3)

Second Breakdown Collector Current with Base Forward Biased (t = 0.5 s non-repetitive) (V _{CE} = 60 Vdc)	2N3055AG MJ15015G, MJ15016G	I _{S/b}	1.95 3.0	– –	Adc
---	--------------------------------	------------------	-------------	--------	-----

ON CHARACTERISTICS (Note 2 and 3)

DC Current Gain (I _C = 4.0 Adc, V _{CE} = 2.0 Vdc) (I _C = 4.0 Adc, V _{CE} = 4.0 Vdc) (I _C = 10 Adc, V _{CE} = 4.0 Vdc)	h _{FE}	10 20 5.0	70 70 –	–
Collector–Emitter Saturation Voltage (I _C = 4.0 Adc, I _B = 400 mAdc) (I _C = 10 Adc, I _B = 3.3 Adc) (I _C = 15 Adc, I _B = 7.0 Adc)	V _{CE(sat)}	– – –	1.1 3.0 5.0	Vdc
Base–Emitter On Voltage (I _C = 4.0 Adc, V _{CE} = 4.0 Vdc)	V _{BE(on)}	0.7	1.8	Vdc

DYNAMIC CHARACTERISTICS (Note 3)

Current–Gain – Bandwidth Product (I _C = 1.0 Adc, V _{CE} = 4.0 Vdc, f = 1.0 MHz)	2N3055AG, MJ15015G MJ15016G	f _T	0.8 2.2	6.0 18	MHz
Output Capacitance (V _{CB} = 10 Vdc, I _E = 0, f = 1.0 MHz)	C _{ob}	60	600	pF	

SWITCHING CHARACTERISTICS (2N3055AG only) (Note 3)

RESISTIVE LOAD					
Delay Time	(V _{CC} = 30 Vdc, I _C = 4.0 Adc, I _{B1} = I _{B2} = 0.4 Adc, t _p = 25 μs Duty Cycle ≤ 2%)	t _d	–	0.5	μs
Rise Time		t _r	–	4.0	μs
Storage Time		t _s	–	3.0	μs
Fall Time		t _f	–	6.0	μs

2. Pulse Test: Pulse Width = 300 μs, Duty Cycle ≤ 2%.
3. Indicates JEDEC Registered Data. (2N3055A)

2N3055AG (NPN), MJ15015G (NPN), MJ15016G (PNP)

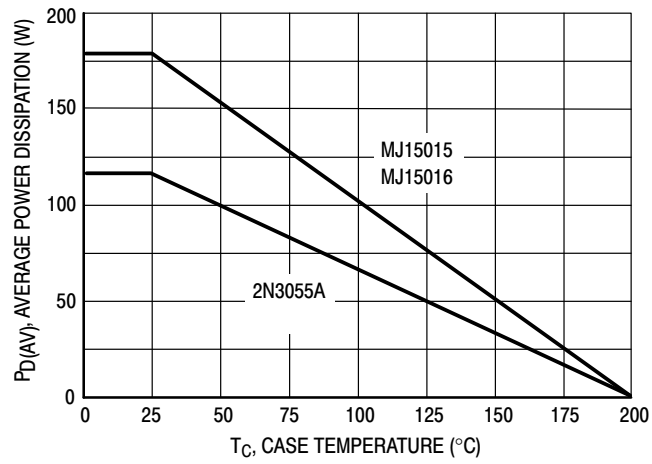

Figure 1. Power Derating

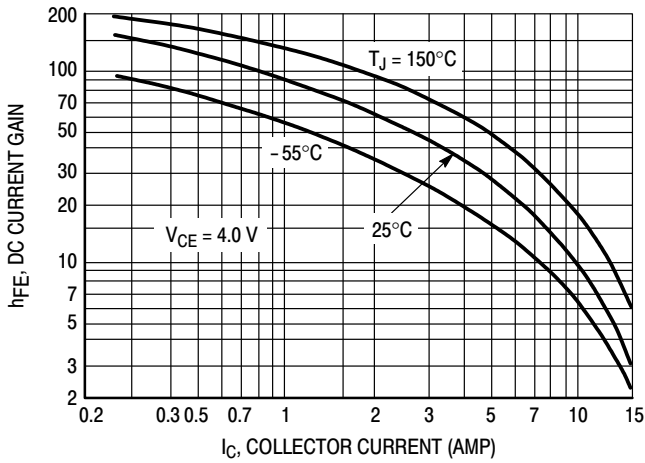

Figure 2. DC Current Gain

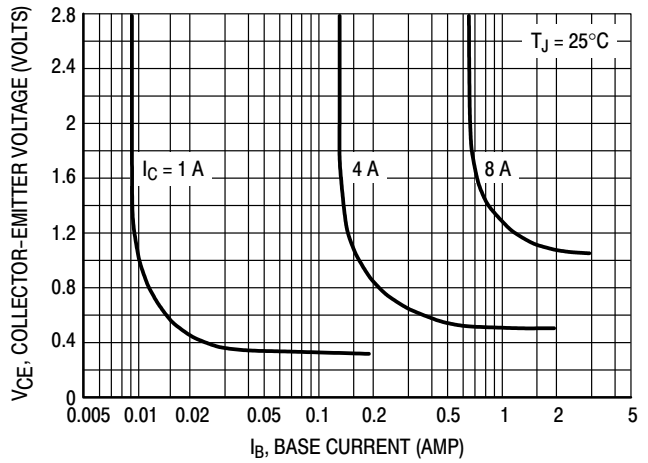

Figure 3. Collector Saturation Region

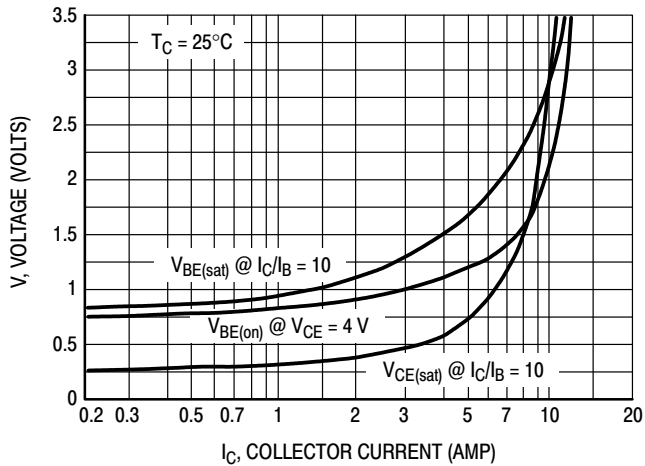

Figure 4. "On" Voltages

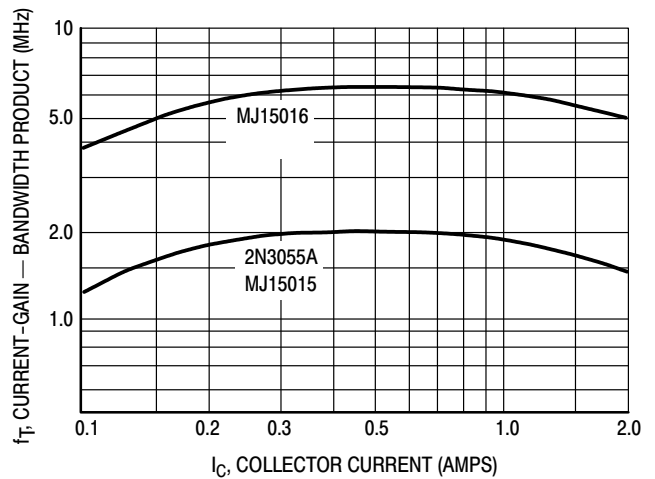

Figure 5. Current-Gain - Bandwidth Product

2N3055AG (NPN), MJ15015G (NPN), MJ15016G (PNP)

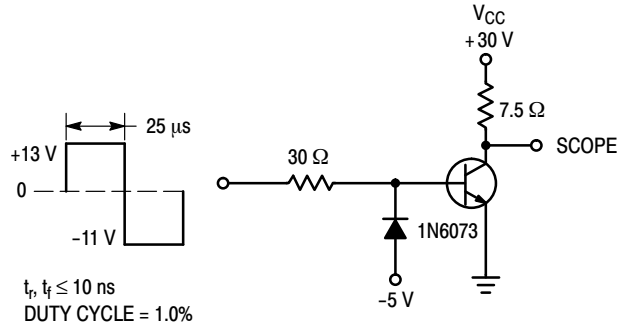

Figure 6. Switching Times Test Circuit
(Circuit shown is for NPN)

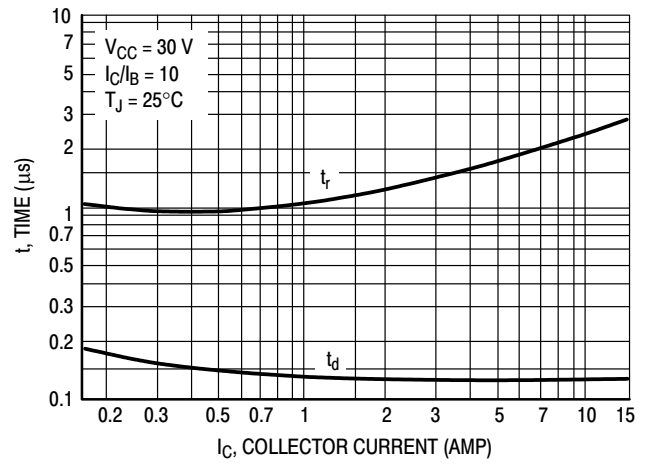

Figure 7. Turn-On Time

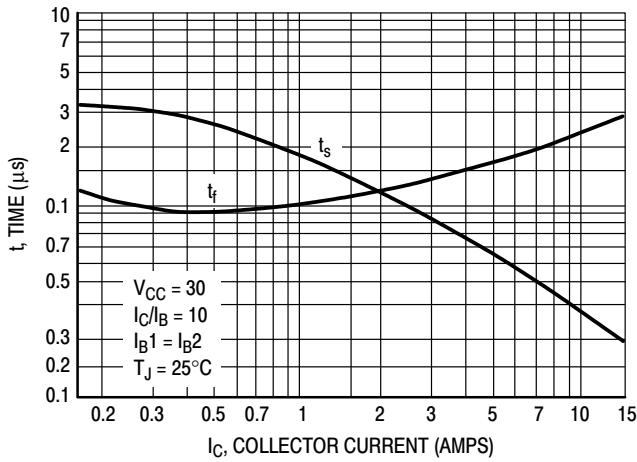

Figure 8. Turn-Off Times

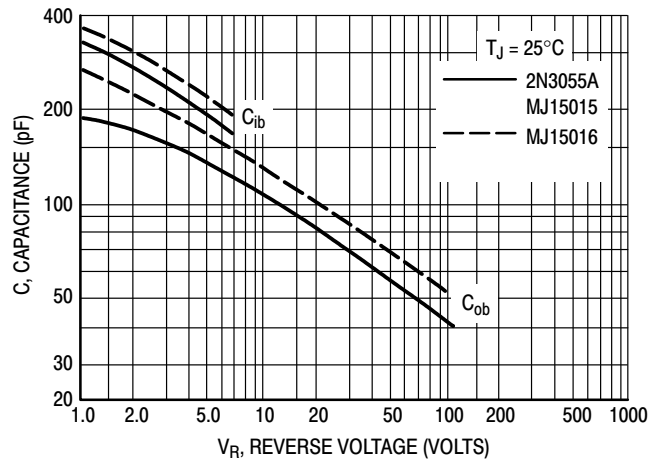

Figure 9. Capacitances

2N3055AG (NPN), MJ15015G (NPN), MJ15016G (PNP)

COLLECTOR CUT-OFF REGION

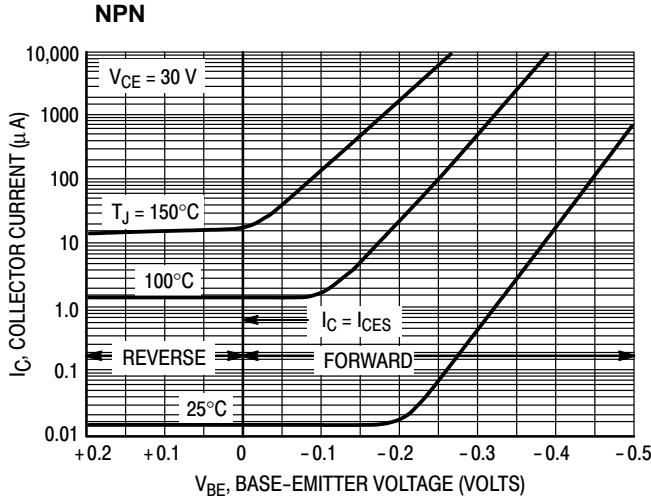

Figure 10. 2N3055A, MJ15015

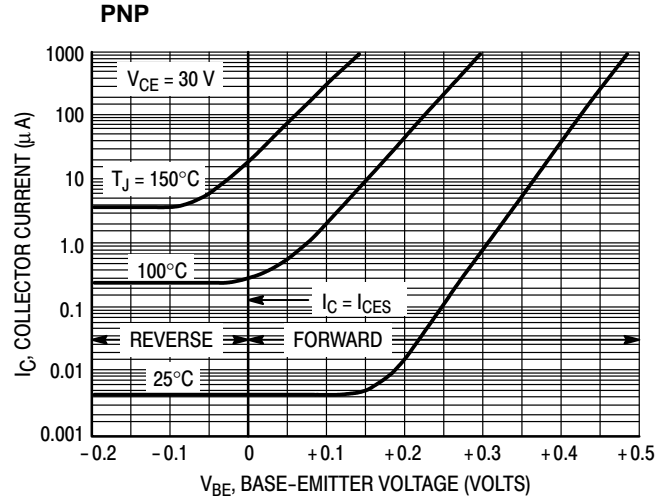

Figure 11. MJ15016

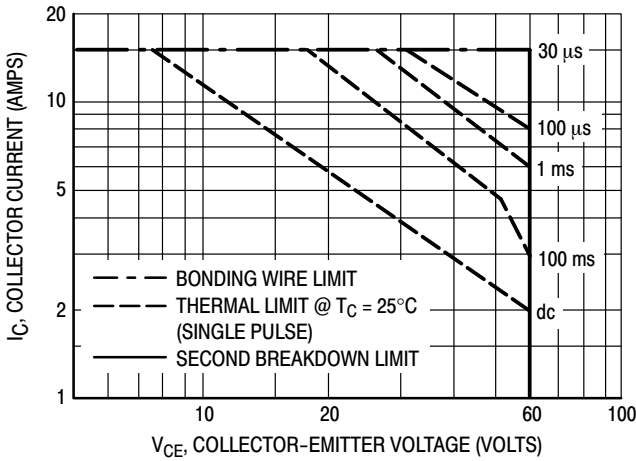

Figure 12. Forward Bias Safe Operating Area
2N3055A

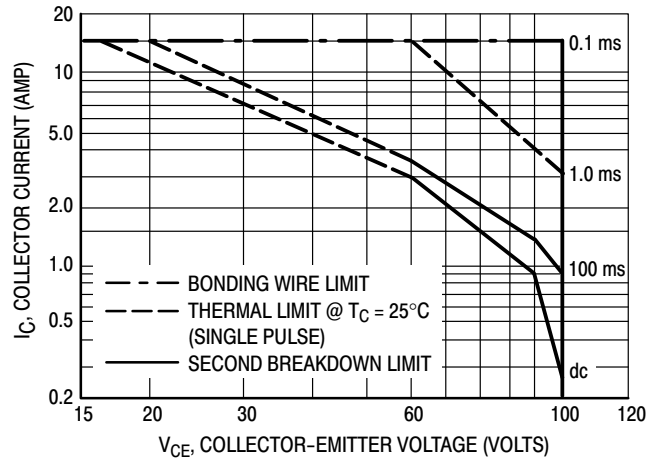

Figure 13. Forward Bias Safe Operating Area
MJ15015, MJ15016

There are two limitations on the power handling ability of a transistor: average junction temperature and second breakdown. Safe Operating area curves indicate $I_C - V_{CE}$ limits of the transistor that must be observed for reliable operation; i.e., the transistor must not be subjected to greater dissipation than the curves indicate.

The data of Figures 12 and 13 is based on $T_C = 25^\circ\text{C}$; $T_{J(pk)}$ is variable depending on power level. Second breakdown pulse limits are valid for duty cycles to 10% but must be derated for temperature according to Figure 1.

ORDERING INFORMATION

Device	Package	Shipping
2N3055AG	TO-204 (Pb-Free)	100 Units / Tray
MJ15015G	TO-204 (Pb-Free)	100 Units / Tray
MJ15016G	TO-204 (Pb-Free)	100 Units / Tray

MECHANICAL CASE OUTLINE PACKAGE DIMENSIONS



TO-204 (TO-3) CASE 1-07 ISSUE Z

DATE 05/18/1988

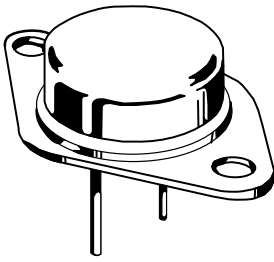

SCALE 1:1

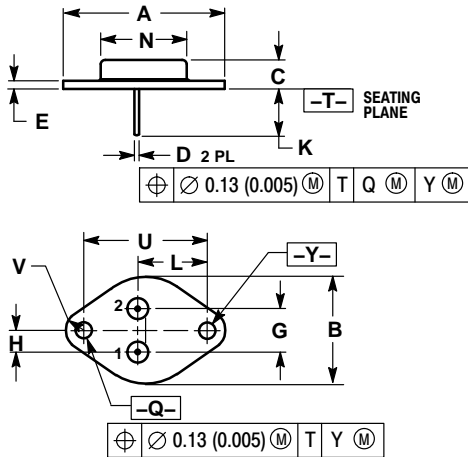

NOTES:

1. DIMENSIONING AND TOLERANCING PER ANSI Y14.5M, 1982.
2. CONTROLLING DIMENSION: INCH.
3. ALL RULES AND NOTES ASSOCIATED WITH REFERENCED TO-204AA OUTLINE SHALL APPLY.

DIM	INCHES		MILLIMETERS	
	MIN	MAX	MIN	MAX
A	1.550 REF	---	39.37 REF	---
B	---	1.050	---	26.67
C	0.250	0.335	6.35	8.51
D	0.038	0.043	0.97	1.09
E	0.055	0.070	1.40	1.77
G	0.430 BSC	---	10.92 BSC	---
H	0.215 BSC	---	5.46 BSC	---
K	0.440	0.480	11.18	12.19
L	0.665 BSC	---	16.89 BSC	---
N	---	0.830	---	21.08
Q	0.151	0.165	3.84	4.19
U	1.187 BSC	---	30.15 BSC	---
V	0.131	0.188	3.33	4.77

- | | | | | |
|--|--|---|---|---|
| <p>STYLE 1:
PIN 1. BASE
2. EMITTER
CASE: COLLECTOR</p> | <p>STYLE 2:
PIN 1. BASE
2. COLLECTOR
CASE: EMITTER</p> | <p>STYLE 3:
PIN 1. GATE
2. SOURCE
CASE: DRAIN</p> | <p>STYLE 4:
PIN 1. GROUND
2. INPUT
CASE: OUTPUT</p> | <p>STYLE 5:
PIN 1. CATHODE
2. EXTERNAL TRIP/DELAY
CASE: ANODE</p> |
| <p>STYLE 6:
PIN 1. GATE
2. EMITTER
CASE: COLLECTOR</p> | <p>STYLE 7:
PIN 1. ANODE
2. OPEN
CASE: CATHODE</p> | <p>STYLE 8:
PIN 1. CATHODE #1
2. CATHODE #2
CASE: ANODE</p> | <p>STYLE 9:
PIN 1. ANODE #1
2. ANODE #2
CASE: CATHODE</p> | |

ON Semiconductor and are trademarks of Semiconductor Components Industries, LLC (SCILLC). SCILLC reserves the right to make changes without further notice to any products herein. SCILLC makes no warranty, representation or guarantee regarding the suitability of its products for any particular purpose, nor does SCILLC assume any liability arising out of the application or use of any product or circuit, and specifically disclaims any and all liability, including without limitation special, consequential or incidental damages. "Typical" parameters which may be provided in SCILLC data sheets and/or specifications can and do vary in different applications and actual performance may vary over time. All operating parameters, including "Typicals" must be validated for each customer application by customer's technical experts. SCILLC does not convey any license under its patent rights nor the rights of others. SCILLC products are not designed, intended, or authorized for use as components in systems intended for surgical implant into the body, or other applications intended to support or sustain life, or for any other application in which the failure of the SCILLC product could create a situation where personal injury or death may occur. Should Buyer purchase or use SCILLC products for any such unintended or unauthorized application, Buyer shall indemnify and hold SCILLC and its officers, employees, subsidiaries, affiliates, and distributors harmless against all claims, costs, damages, and expenses, and reasonable attorney fees arising out of, directly or indirectly, any claim of personal injury or death associated with such unintended or unauthorized use, even if such claim alleges that SCILLC was negligent regarding the design or manufacture of the part. SCILLC is an Equal Opportunity/Affirmative Action Employer.

ON Semiconductor and  are trademarks of Semiconductor Components Industries, LLC dba ON Semiconductor or its subsidiaries in the United States and/or other countries. ON Semiconductor owns the rights to a number of patents, trademarks, copyrights, trade secrets, and other intellectual property. A listing of ON Semiconductor's product/patent coverage may be accessed at www.onsemi.com/site/pdf/Patent-Marking.pdf. ON Semiconductor reserves the right to make changes without further notice to any products herein. ON Semiconductor makes no warranty, representation or guarantee regarding the suitability of its products for any particular purpose, nor does ON Semiconductor assume any liability arising out of the application or use of any product or circuit, and specifically disclaims any and all liability, including without limitation special, consequential or incidental damages. Buyer is responsible for its products and applications using ON Semiconductor products, including compliance with all laws, regulations and safety requirements or standards, regardless of any support or applications information provided by ON Semiconductor. "Typical" parameters which may be provided in ON Semiconductor data sheets and/or specifications can and do vary in different applications and actual performance may vary over time. All operating parameters, including "Typicals" must be validated for each customer application by customer's technical experts. ON Semiconductor does not convey any license under its patent rights nor the rights of others. ON Semiconductor products are not designed, intended, or authorized for use as a critical component in life support systems or any FDA Class 3 medical devices or medical devices with a same or similar classification in a foreign jurisdiction or any devices intended for implantation in the human body. Should Buyer purchase or use ON Semiconductor products for any such unintended or unauthorized application, Buyer shall indemnify and hold ON Semiconductor and its officers, employees, subsidiaries, affiliates, and distributors harmless against all claims, costs, damages, and expenses, and reasonable attorney fees arising out of, directly or indirectly, any claim of personal injury or death associated with such unintended or unauthorized use, even if such claim alleges that ON Semiconductor was negligent regarding the design or manufacture of the part. ON Semiconductor is an Equal Opportunity/Affirmative Action Employer. This literature is subject to all applicable copyright laws and is not for resale in any manner.

PUBLICATION ORDERING INFORMATION

LITERATURE FULFILLMENT:

Email Requests to: orderlit@onsemi.com

ON Semiconductor Website: www.onsemi.com

TECHNICAL SUPPORT

North American Technical Support:
Voice Mail: 1 800-282-9855 Toll Free USA/Canada
Phone: 011 421 33 790 2910

Europe, Middle East and Africa Technical Support:

Phone: 00421 33 790 2910

For additional information, please contact your local Sales Representative